



Surgical Instruments Catalogue

EN Scalpels

DE Skalpelle

ES Bisturías

Page 1 to 15





Standard
TBI 01-1000-04 # 4

TBI 01-1001-4L # 4L
TBI 01-1001-4XL # 4XL

TBI 01-1002-4L # 4L
TBI 01-1002-4XL # 4XL
angled

TBI 01-1003-07 # 7

TBI 01-1004-07 # 7K

Collin
TBI 01-1005-08 Fig. 8



Standard
 TBI 01-1006-03 # 3



TBI 01-1007-03 # 3



TBI 01-1008-04 # 4



TBI 01-1009-3L # 3L
 TBI 01-1009-3XL # 3XL



TBI 01-1010-3L # 3L
 TBI 01-1010-3XL # 3XL
 angled





Collin
 TBI 01-1011-09
 Hollow, No. 9



Super
 TBI 01-1012-10
 Hollow, No. 10



TBI 01-1013-00
 Hollow, round



TBI 01-1014-00
 Plastics



17cm/6 3/4"



Fig. 1

TBI 01-1015-01
 17cm/6 3/4"



Fig. 2

TBI 01-1015-02



Fig. 3

TBI 01-1015-03



Fig. 4

TBI 01-1015-04



Fig. 5

TBI 01-1015-05



Fig. 6

TBI 01-1015-06



Fig. 7

TBI 01-1015-07



Fig. 8

TBI 01-1015-08



Fig. 9

TBI 01-1015-09



Fig. 10

TBI 01-1015-10





Fig. 1 TBI 01-1016-01 Fig. 2 TBI 01-1016-02 Fig. 3 TBI 01-1016-03 Fig. 4 TBI 01-1016-04 Fig. 5 TBI 01-1016-05 Fig. 6 TBI 01-1016-06 Fig. 7 TBI 01-1016-07 Fig. 8 TBI 01-1016-08 Fig. 9 TBI 01-1016-09



17cm/6³/₄"



Fig. 10 TBI 01-1016-10 Fig. 11 TBI 01-1016-11 Fig. 12 TBI 01-1016-12 Fig. 13 TBI 01-1016-13 Fig. 14 TBI 01-1016-14 Fig. 15 TBI 01-1016-15 Fig. 16 TBI 01-1016-16 Fig. 18 TBI 01-1016-18



Fig. 27 TBI 01-1016-27 Fig. 38 TBI 01-1016-38 Fig. 40 TBI 01-1016-40 Fig. 46 TBI 01-1016-46 Fig. 61 TBI 01-1016-61 Fig. 63 TBI 01-1016-63



Dieffenbach
17cm/6¾"



Fig. 1
TBI 01-1017-01



Fig. 2
TBI 01-1017-02



Fig. 3
TBI 01-1017-03



Fig. 4
TBI 01-1017-04



Fig. 5
TBI 01-1017-05



Fig. 6
TBI 01-1017-06



Fig. 7
TBI 01-1017-07



Fig. 8
TBI 01-1017-08



Fig. 9
TBI 01-1017-09



Fig. 15
TBI 01-1017-15



Fig. 16
TBI 01-1017-16





◀ Fig. 1

Bergmann
 TBI 01-1018-01
 14.5cm/5¾"



Fig. 2

TBI 01-1018-02



Fig. 3

TBI 01-1018-03



Fig. 4

TBI 01-1018-04



Dieffenbach
 13cm/5¼"



Fig. 1

TBI 01-1019-01



Fig. 2

TBI 01-1019-02



Fig. 3

TBI 01-1019-03



Fig. 4

TBI 01-1019-04



Fig. 5

TBI 01-1019-05



Fig. 6

TBI 01-1019-06



Fig. 7

TBI 01-1019-07



Fig. 8

TBI 01-1019-08



Fig. 9

TBI 01-1019-09



Fig. 10

TBI 01-1019-10



Fig. 11

TBI 01-1019-11



Fig. 12

TBI 01-1019-12

SCALPEL

Dissecting Knives — EN
 Anatomische Skalpelle — DE
 Bisturías para disección anatómica — ES



Simon
20cm/8"



Fig. 1
TBI 01-1020-01



Fig. 2
TBI 01-1020-02



Fig. 3
TBI 01-1020-03

Fig. 4
TBI 01-1020-04



Ulrich
22.5 cm/9"



Fig. 1
TBI 01-1021-01



Fig. 2
TBI 01-1021-02



Fig. 3
TBI 01-1021-03



Simon
23.5 cm/9 1/4"



Fig. 1
TBI 01-1022-01



Fig. 2
TBI 01-1022-02



Fig. 3
TBI 01-1022-03



Fig. 4
TBI 01-1022-04



TBI 01-1023-07
7.5 cm/3"



TBI 01-1024-08
8 cm/3 1/4"





Brain knives



Post mortem knives



Autopsy knives



Virchow

TBI 01-1025-16 26cm
Blade Size 160mm

TBI 01-1025-20 33.5cm
Blade Size 200mm

TBI 01-1025-24 38cm
Blade Size 240mm

Walb

TBI 01-1026-11 26cm
Blade Size 110mm

TBI 01-1026-14 29cm
Blade Size 140mm

TBI 01-1026-17 31cm
Blade Size 170mm

TBI 01-1027-10 25.5cm
Blade Size 100mm

Virchow

TBI 01-1028-08
Blade Size 8.5 cm

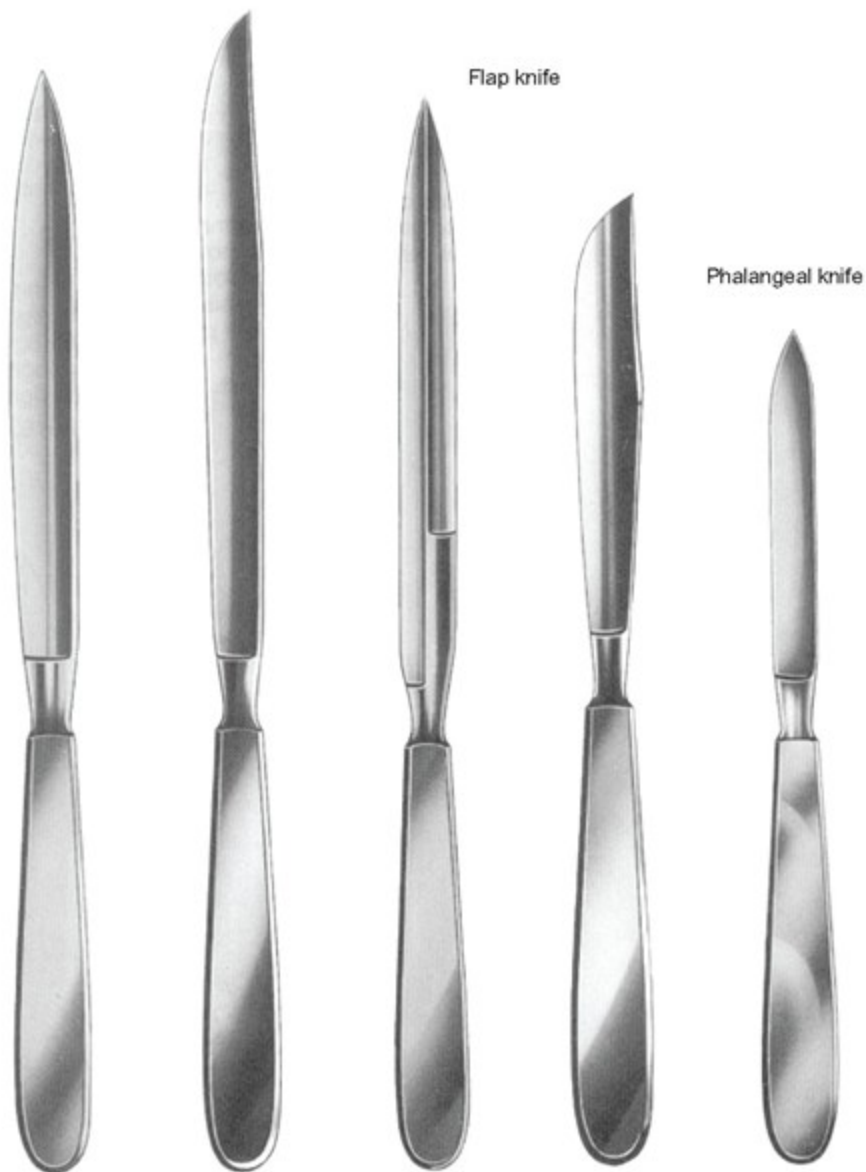

Length of blades		Collin	Liston	Catlin	Langenbeck	Phalangeal knife
cm	in					
9.5	3 3/4					TBI 01-1033-09
11.0	4 1/2			TBI 01-1031-11		
12.0	4 3/4				TBI 01-1032-12	
13.0	5	TBI 01-1029-13				
15.0	6					
16.0	6 1/4	TBI 01-1029-16		TBI 01-1031-16		
17.0	6 3/4		TBI 01-1030-17			
19.0	7 1/2	TBI 01-1029-19		TBI 01-1031-19		
20.0	8		TBI 01-1030-20			
22.0	8 3/4	TBI 01-1029-22		TBI 01-1031-22		
28.0	11	TBI 01-1029-28				





Troutman-Chris
 TBI 01-1034-09
 9 cm/3½"



Troutman-Chris
 TBI 01-1035-09
 9cm/3½"



TBI 01-1036-11
 11cm/4½"



Castroviejo
 TBI 01-1037-13
 13cm/5¼"



TBI 01-1038-18
 18cm/7"

SCALPEL

Dissecting Knives — EN
 Anatomische Skalpelle — DE
 Bisturías para disección anatómica — ES



Skull Breaker

TBI 01-1039-14
 14 cm/5½"

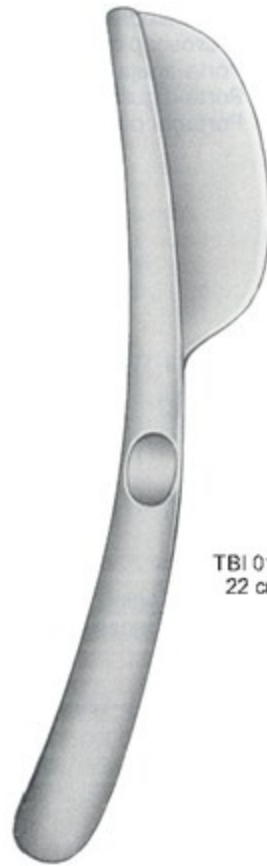

Rachiotome

TBI 01-1040-22
 22 cm/8¾"



Osteotome

TBI 01-1041-13
 13 cm/5"



Brunetti **Brunetti**
 TBI 01-1042-28 TBI 01-1043-28
 28.5 cm/11¼"

Muscle hooks



TBI 01-1044-06
 6.5 cm/2½"



TBI 01-1045-07
 7 cm/2¾"



TBI 01-1046-01





Microscopic needles



TBI 01-1047-13
13 cm/5"



TBI 01-1048-13
13 cm/5"



Microscopic needle holder

Kolle
TBI 01-1049-24
24 cm/ 9 1/2"



Loop for needle holder

TBI 01-1050-06
6 cm/2 1/4"

Post mortem needles



TBI 01-1051-01

TBI 01-1051-02

TBI 01-1051-03

TBI 01-1051-04

TBI 01-1051-05

TBI 01-1051-06



TBI 01-1052-00



TBI 01-1053-00





SCHINK
TBI 01-1054-30
30 cm/12"



TBI 01-1054-01

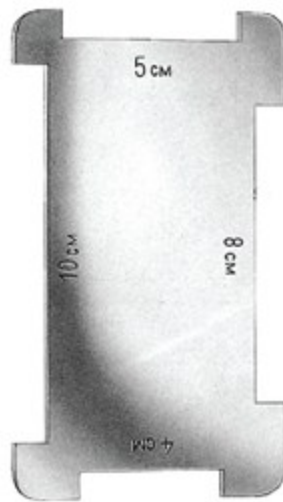

TBI 01-1055-00



HUMBY
TBI 01-1056-31
31 cm/12 1/2"



TBI 01-1056-01



SILVER
TBI 01-1057-19
19.5 cm/7 3/4"

EN Diagnostics

DE Diagnostik

ES Diagnóstico

Page 16 to 21





Taylor
 TBI 02-1101-18 18 cm/7 1/8"
 TBI 02-1101-20 20 cm/8"



Dejerine
 TBI 02-1102-20
 20 cm/8"



Dejerine
 TBI 02-1103-21 21 cm/8 1/4"
 TBI 02-1103-35 35 cm/14"



Neuro-Duoflex
 TBI 02-1104-22
 22 cm/8 3/4"

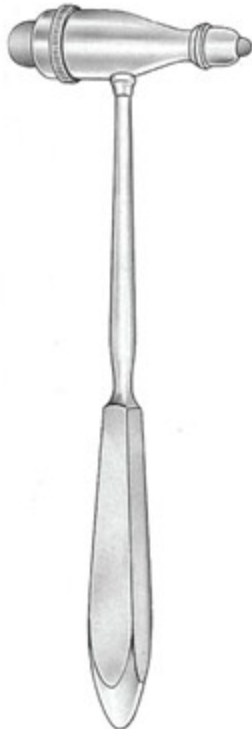

Troemner
 TBI 02-1105-24
 24 cm/9 3/4"



Berliner
 TBI 02-1106-17 17cm/7"
 TBI 02-1106-20 20cm/8"



Buck
 TBI 02-1107-18
 18 cm/7 1/2"



Buck (Telescopic)
 TBI 02-1108-18
 18 cm/7 1/2"



Traube
 TBI 02-1109-16
 16 cm/6 1/4"



Troemner
 TBI 02-1110-21
 21cm/8 1/4"



Divers-Duoflex
 TBI 02-1111-22
 22 cm/8 3/4"



Babinsky
 TBI 02-1112-22 22 cm/8 1/4"
 TBI 02-1112-25 25 cm/10"



Rabiner
 TBI 02-1113-23
 23 cm/9 "



National Hospital
 TBI 02-1114-50 50 mm Ø
 TBI 02-1114-60 60 mm Ø
 TBI 02-1114-70 70 mm Ø
 33 cm/13"



Queen Sqaure
 TBI 02-1115-26
 26 cm/10 1/4"





Pinard
 TBI 02-1116-18
 18 cm/7½"
 (wooden)



Pinard
 TBI 02-1117-15
 15 cm/6"
 (plastic)



Pinard
 TBI 02-1118-15
 15 cm/6"
 (aluminum)



Pinard
 TBI 02-1119-15
 15 cm/6"
 (aluminum)



Aly
 TBI 02-1120-17
 17cm/6¾"



Wartenberg
 TBI 02-1121-19
 19cm/7½"



Weber
 TBI 02-1122-09
 9cm/3½"



TBI 02-1123-15 15 cm/6"
 TBI 02-1123-30 30 cm/12"
 TBI 02-1123-60 60 cm/24"

Goniometer



Moltgen
TBI 02-1124-00



Townley
TBI 02-1125-10
10cm/4"



Caroll
TBI 02-1126-14
14cm/5 1/2"



Collin
for children TBI 02-1127-01
for adults TBI 02-1127-02



Ford Stethoscope
TBI 02-1128-00
Double Sided



Dual Stethoscope
TBI 02-1129-00
Single Sided





TBI 02-1130-00
Head Lamp



TBI 02-1131-00
Head Lamp



TBI 02-1132-00
Head Lamp



Jansen
TBI 02-1133-00
Head Lamp

Available in conventional and fiber



TBI 02-1134-00
Otoscope set in Case



TBI 02-1135-00
Otoscope set in Pouch



TBI 02-1136-00
Ophthalmoscope set



TBI 02-1137-00
Ophthalmoscope and Otoscope set



TBI 02-1138-00
Complete ENT set



EN Scissors

DE Scheren

ES Tijeras

Page 38 to 64

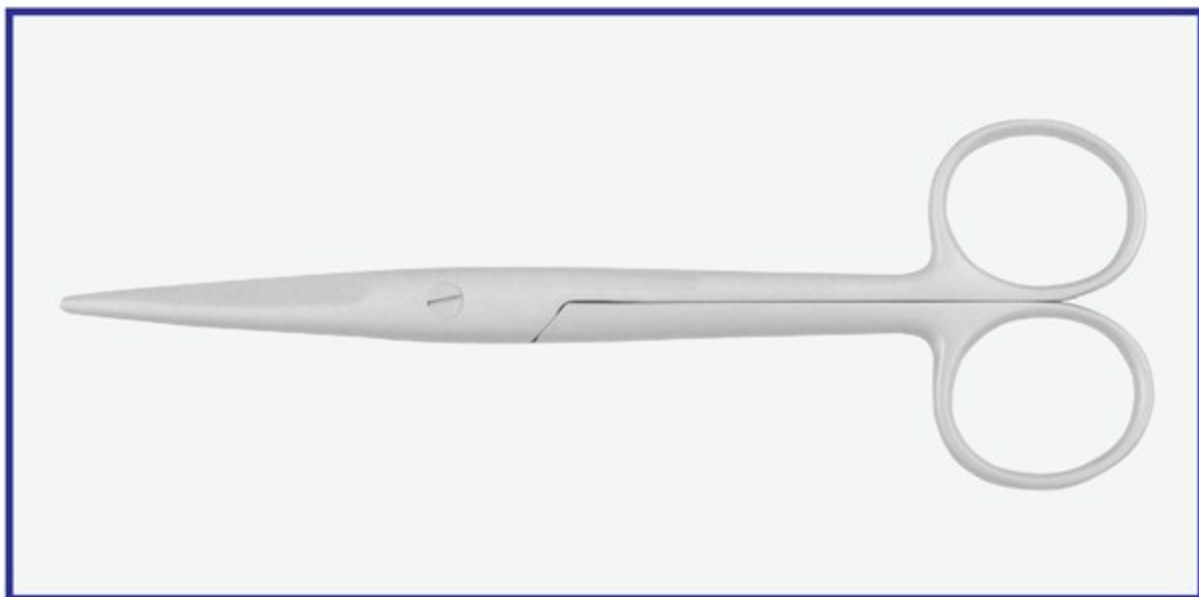

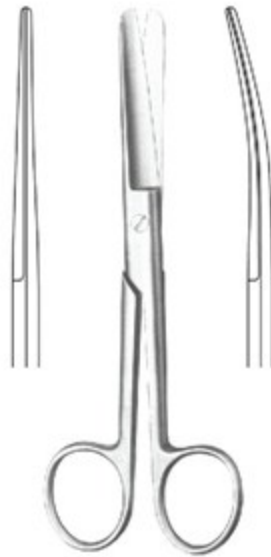

STANDARD
blunt/blunt

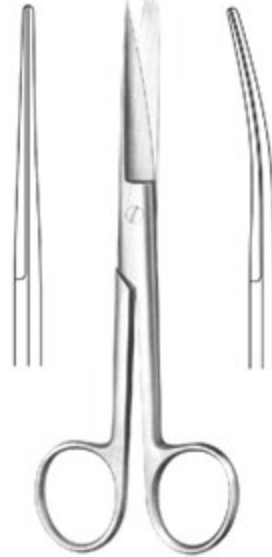

STANDARD
sharp/blunt

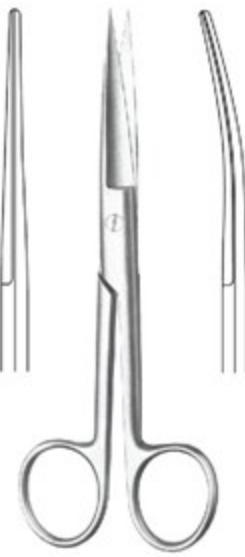

STANDARD
sharp/sharp

cm	in	Straight	Curved	Straight	Curved	Straight	Curved
10.5	4 1/8"	TBI 04-1301-10	TBI 04-1302-10	TBI 04-1303-10	TBI 04-1304-10	TBI 04-1305-10	TBI 04-1306-10
11.5	4 1/2"	TBI 04-1301-11	TBI 04-1302-11	TBI 04-1303-11	TBI 04-1304-11	TBI 04-1305-11	TBI 04-1306-11
13.0	5 1/8"	TBI 04-1301-13	TBI 04-1302-13	TBI 04-1303-13	TBI 04-1304-13	TBI 04-1305-13	TBI 04-1306-13
14.5	5 3/4"	TBI 04-1301-14	TBI 04-1302-14	TBI 04-1303-14	TBI 04-1304-14	TBI 04-1305-14	TBI 04-1306-14
15.5	6 1/8"	TBI 04-1301-15	TBI 04-1302-15	TBI 04-1303-15	TBI 04-1304-15	TBI 04-1305-15	TBI 04-1306-15
16.5	6 1/2"	TBI 04-1301-16	TBI 04-1302-16	TBI 04-1303-16	TBI 04-1304-16	TBI 04-1305-16	TBI 04-1306-16
17.5	6 7/8"	TBI 04-1301-17	TBI 04-1302-17	TBI 04-1303-17	TBI 04-1304-17	TBI 04-1305-17	TBI 04-1306-17
18.5	7 1/4"	TBI 04-1301-18	TBI 04-1302-18	TBI 04-1303-18	TBI 04-1304-18	TBI 04-1305-18	TBI 04-1306-18
20.0	7 7/8"	TBI 04-1301-20	TBI 04-1302-20	TBI 04-1303-20	TBI 04-1304-20	TBI 04-1305-20	TBI 04-1306-20

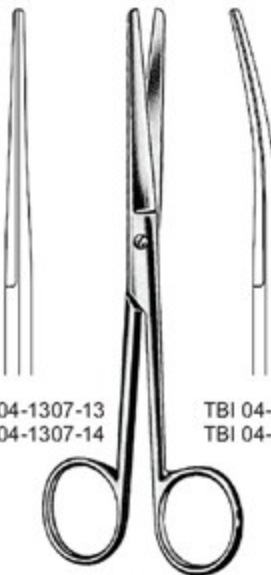

GRAZIL
blunt/blunt

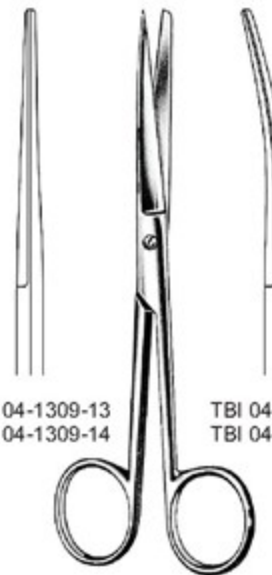

GRAZIL
sharp/blunt

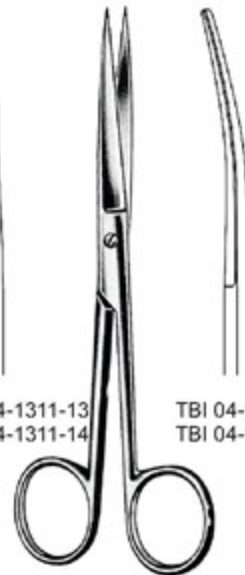

GRAZIL
sharp/sharp

13.0	5 1/8"	TBI 04-1307-13	TBI 04-1308-13	TBI 04-1309-13	TBI 04-1310-13	TBI 04-1311-13	TBI 04-1312-13
14.5	5 3/4"	TBI 04-1307-14	TBI 04-1308-14	TBI 04-1309-14	TBI 04-1310-14	TBI 04-1311-14	TBI 04-1312-14



INCISION
 TBI 04-1313-13 13 cm/5 1/4"
 TBI 04-1313-14 14.5 cm/5 3/4"



TBI 04-1314-14 Straight
 TBI 04-1315-14 Curved
 1/2
DEAVER
 14 cm/5 1/2"

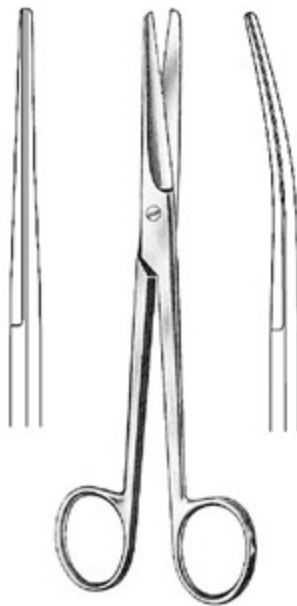

MAYO
 straight
 TBI 04-1316-14 14.5 cm/5 3/4"
 TBI 04-1316-15 15 cm/5 7/8"
 TBI 04-1316-17 17 cm/6 3/4"
 TBI 04-1316-23 23 cm/9"
 curved
 TBI 04-1317-14
 TBI 04-1317-15
 TBI 04-1317-17
 TBI 04-1317-23



MAYO-HARRINGTON
 straight
 TBI 04-1318-23 23 cm/9"
 TBI 04-1318-28 28 cm/11"
 curved
 TBI 04-1319-23
 TBI 04-1319-28

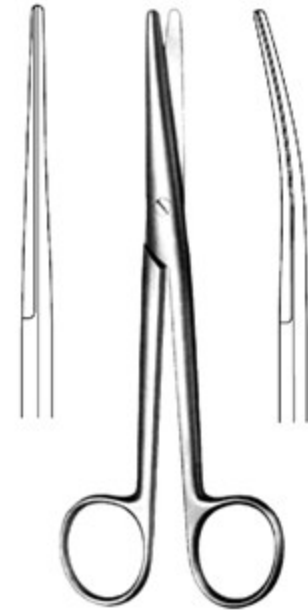

MAYO-STILLE
 straight
 TBI 04-1320-15 15 cm/5 7/8"
 TBI 04-1320-16 16.5 cm/6 1/2"
 TBI 04-1320-17 17 cm/6 3/4"
 TBI 04-1320-19 19.5 cm/7 1/2"
 TBI 04-1320-21 21 cm/8 1/4"
 curved
 TBI 04-1321-15
 TBI 04-1321-16
 TBI 04-1321-17
 TBI 04-1321-19
 TBI 04-1321-21





MAYO-NOBLE
16.5 cm/6 1/2"



TBI 04-1322-16
straight



TBI 04-1323-16
curved



WERTHEIM



TBI 04-1324-20
20 cm/7 7/8"



TBI 04-1324-23
23 cm/9"

SCISSORS

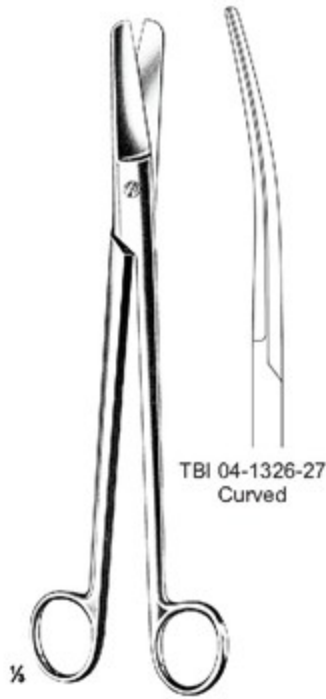

DUBOIS
TBI 04-1325-27
27 cm/10 1/2"
Straight

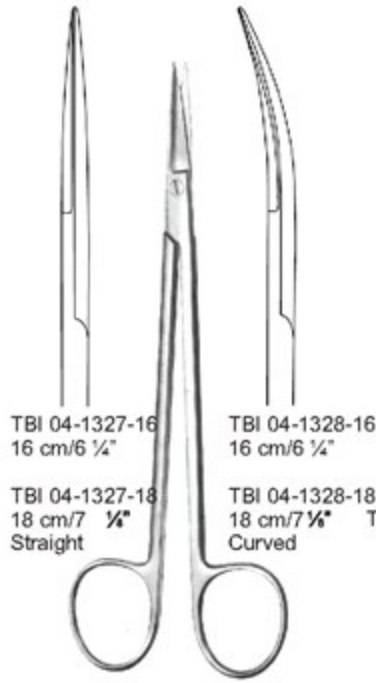

KELLY

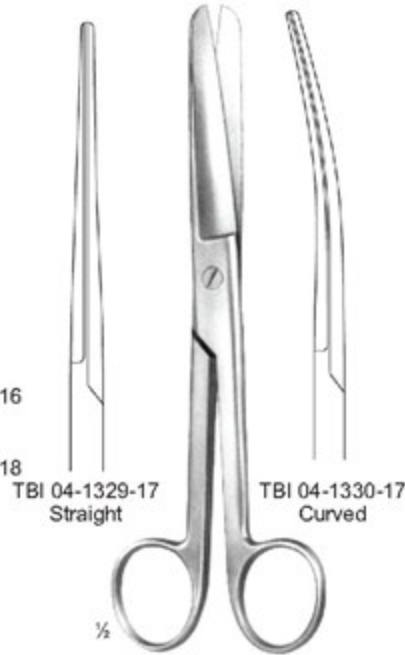

DOYEN
17.5 cm/6 7/8"

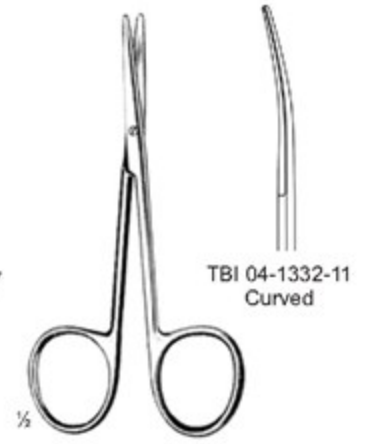

METZENBAUM BABY
TBI 04-1331-11
11.5 cm/4 1/2"
Straight

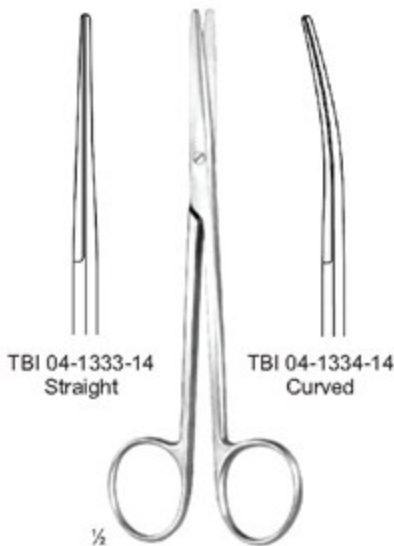

METZENBAUM
14.5 cm/5 3/4"
blunt/blunt

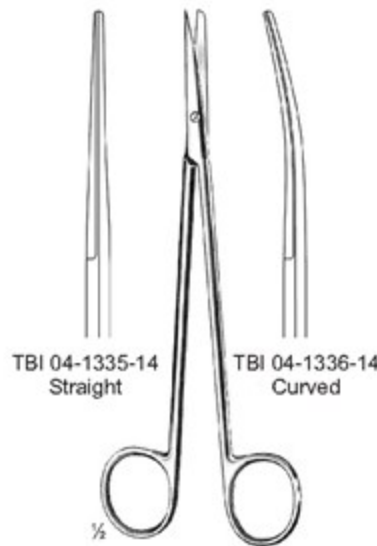

METZENBAUM
14.5 cm/5 3/4"
sharp/blunt

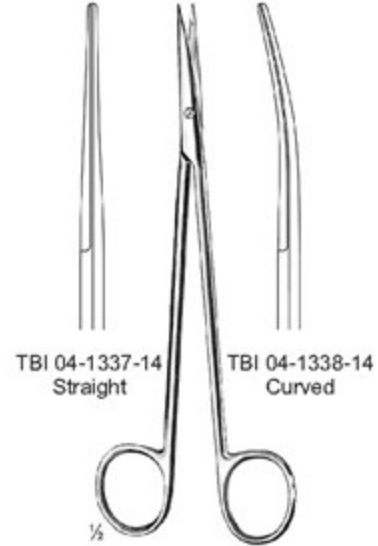

METZENBAUM
14.5 cm/5 3/4"
sharp/sharp



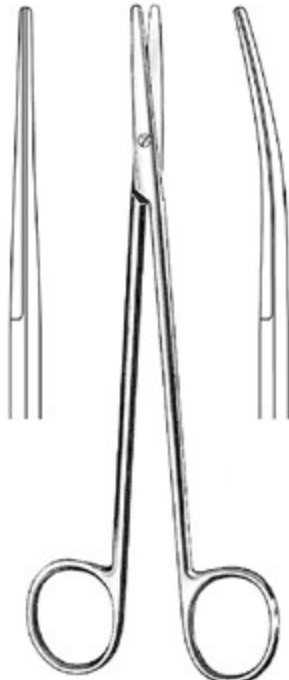

METZENBAUM-NELSON
blunt/blunt

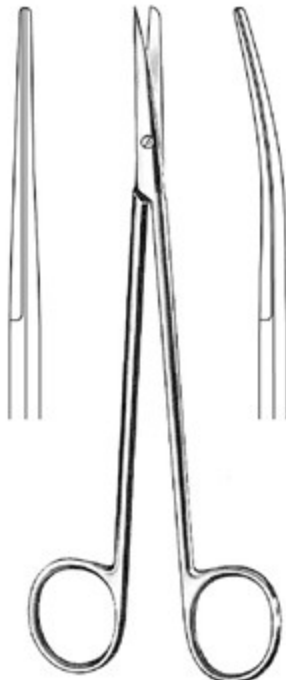

METZENBAUM-NELSON
sharp/blunt

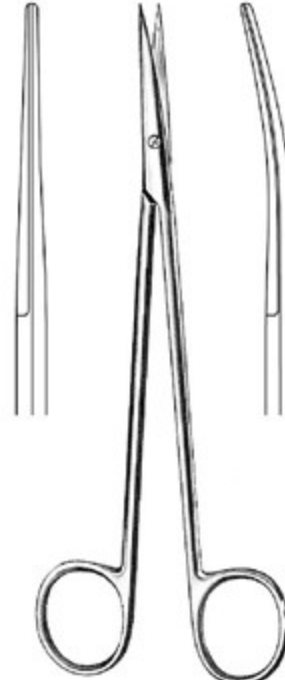

METZENBAUM-NELSON
sharp/sharp

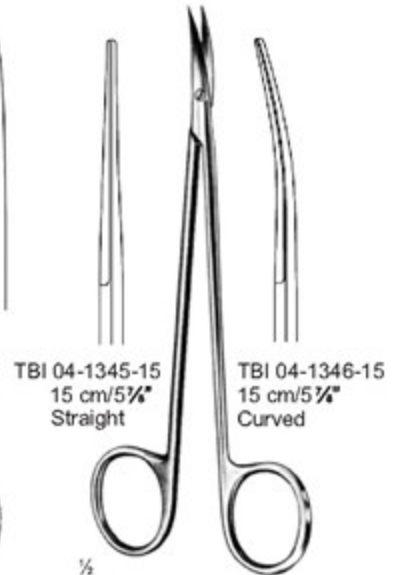

TBI 04-1345-15
15 cm/5 7/8"
Straight

TBI 04-1346-15
15 cm/5 7/8"
Curved

**NERVE DISSECTING
SCISSORS**

cm	in	straight	curved	straight	curved	straight	curved
18	7 1/8"	TBI 04-1339-18	TBI 04-1340-18	TBI 04-1341-18	TBI 04-1342-18	TBI 04-1343-18	TBI 04-1344-18
20	7 7/8"	TBI 04-1339-20	TBI 04-1340-20	TBI 04-1341-20	TBI 04-1342-20	TBI 04-1343-20	TBI 04-1344-20
23	9"	TBI 04-1339-23	TBI 04-1340-23	TBI 04-1341-23	TBI 04-1342-23	TBI 04-1343-23	TBI 04-1344-23
25	9 7/8"	TBI 04-1339-25	TBI 04-1340-25	TBI 04-1341-25	TBI 04-1342-25	TBI 04-1343-25	TBI 04-1344-25
28	11"	TBI 04-1339-28	TBI 04-1340-28	TBI 04-1341-28	TBI 04-1342-28	TBI 04-1343-28	TBI 04-1344-28
30	11 3/4"	TBI 04-1339-30	TBI 04-1340-30	TBI 04-1341-30	TBI 04-1342-30	TBI 04-1343-30	TBI 04-1344-30

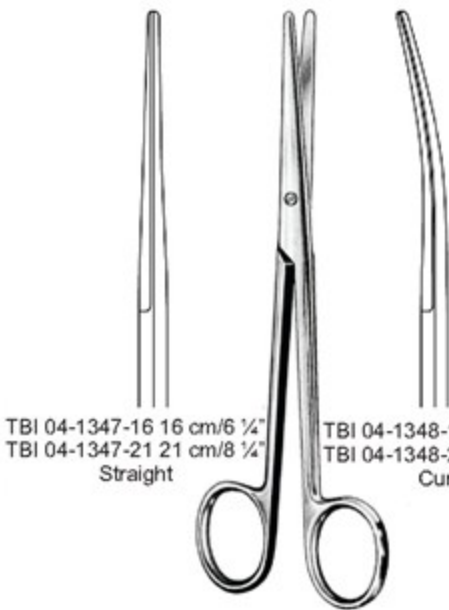

TBI 04-1347-16 16 cm/6 1/4"
TBI 04-1347-21 21 cm/8 1/4"
Straight

TBI 04-1348-16 16 cm/6 1/4"
TBI 04-1348-21 21 cm/8 1/4"
Curved

LEXER

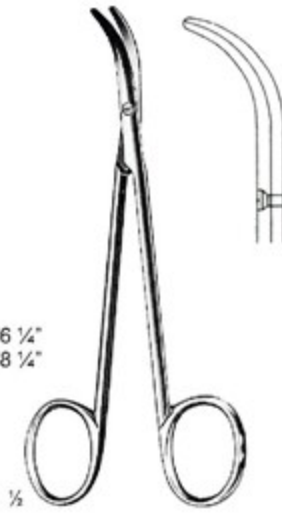

FOMON
TBI 04-1349-13
13.5 cm/5 3/8"

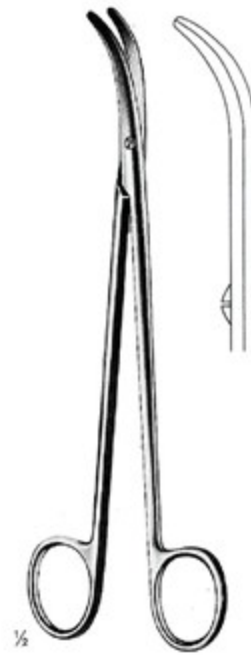

THOREK
TBI 04-1350-19
19 cm/7 1/2"

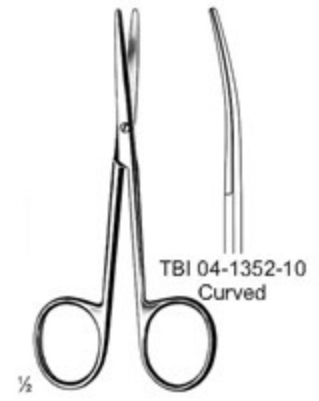

TBI 04-1352-10
Curved

LEXER-BABY
TBI 04-1351-10
10 cm/3 7/8"
Straight

SCISSORS

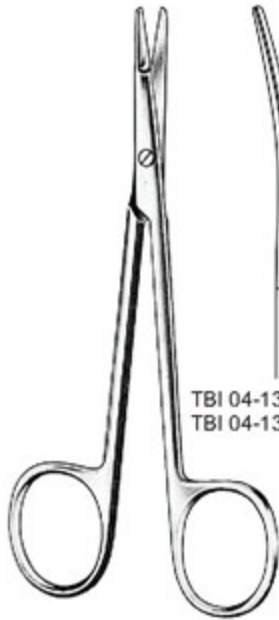

TBI 04-1354-12 12 cm/4 3/4"
 TBI 04-1354-15 15 cm/5 3/4"

KILNER
 TBI 04-1353-13
 13 cm/5 1/4"



CRAFOORD
 TBI 04-1355-30
 30 cm/11 3/4"



SATINSKY
 TBI 04-1356-24
 24.5 cm/9 3/4"

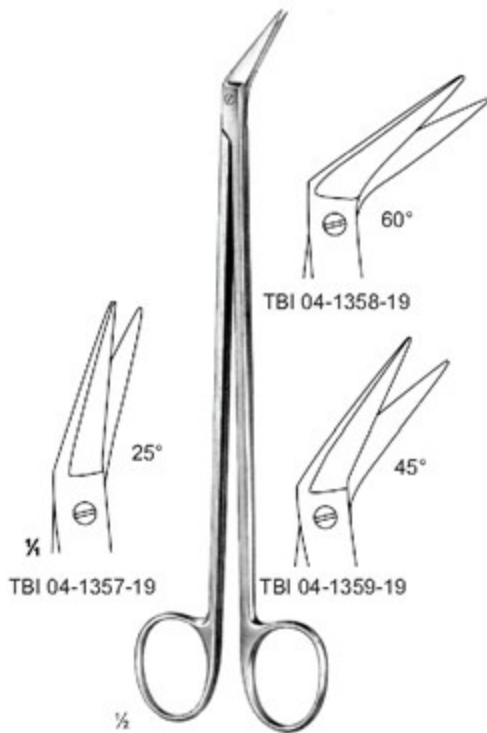

TBI 04-1357-19

TBI 04-1358-19

TBI 04-1359-19

POTTS-SMITH
 19 cm/7 1/2"



DEBAKEY



16 cm/6 1/4"
 23 cm/9"
 28 cm/11"

TBI 04-1360-16

TBI 04-1360-23

TBI 04-1360-28

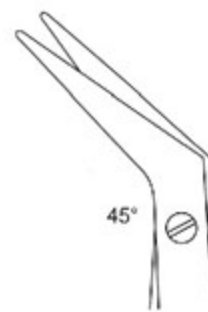

TBI 04-1361-16
 TBI 04-1361-23
 TBI 04-1361-28

TBI 04-1361-16

TBI 04-1361-23

TBI 04-1361-28

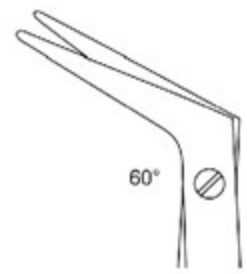

TBI 04-1362-16
 TBI 04-1362-23
 TBI 04-1362-28

TBI 04-1362-16

TBI 04-1362-23

TBI 04-1362-28



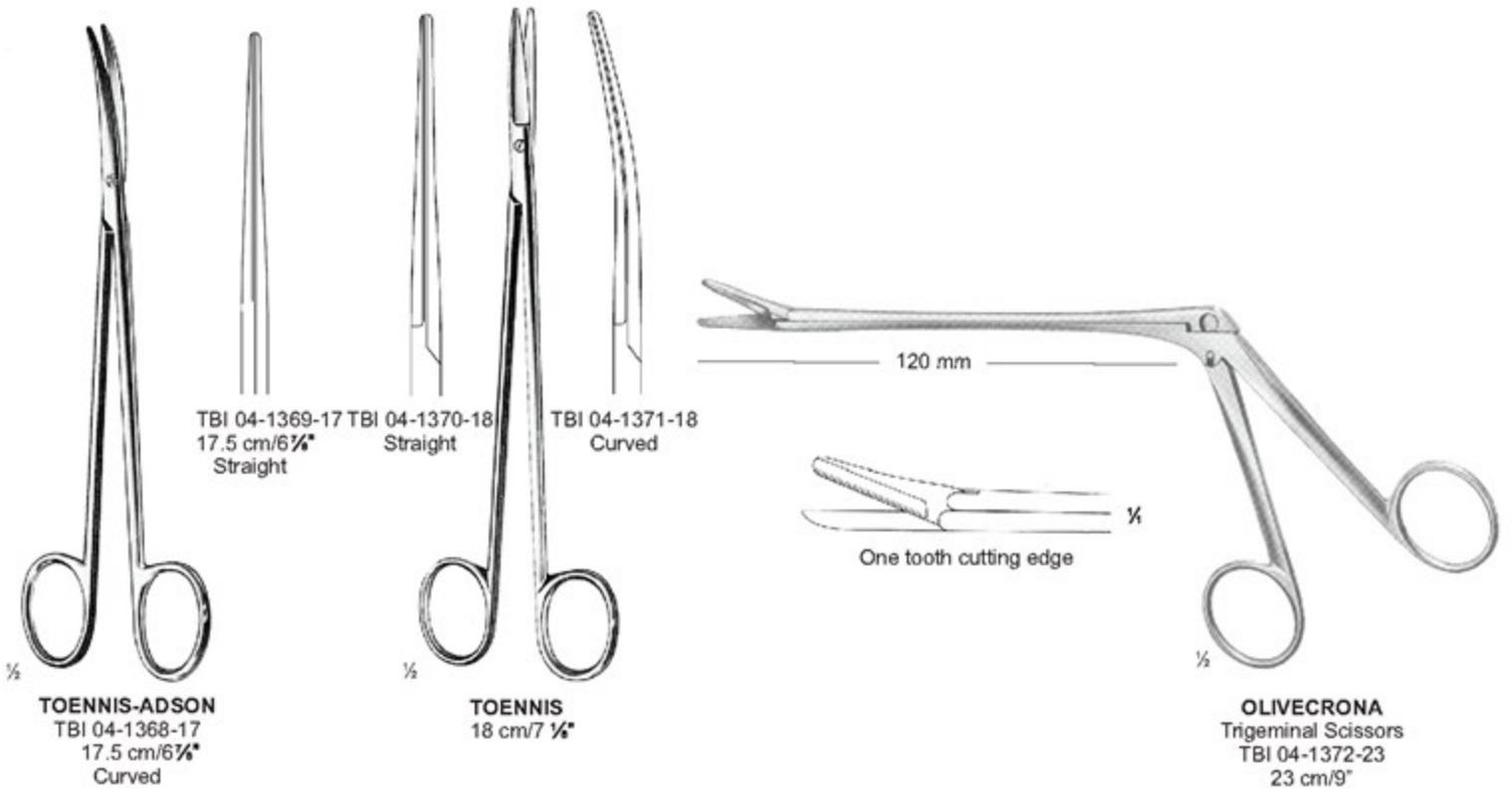
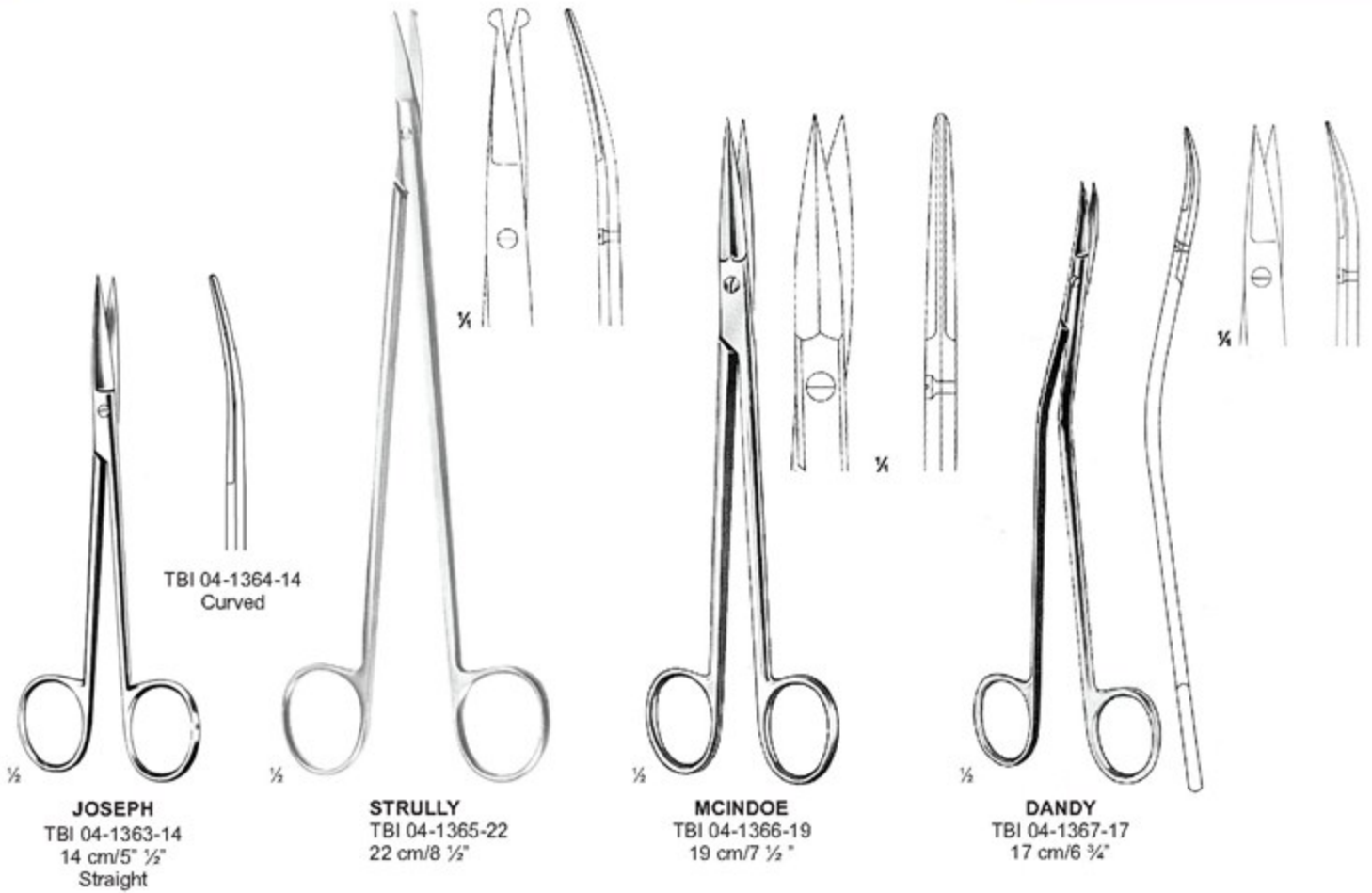

SCISSORS



RESANO
 TBI 04-1373-25
 25 cm/9 7/8"
 Cartilage scissors

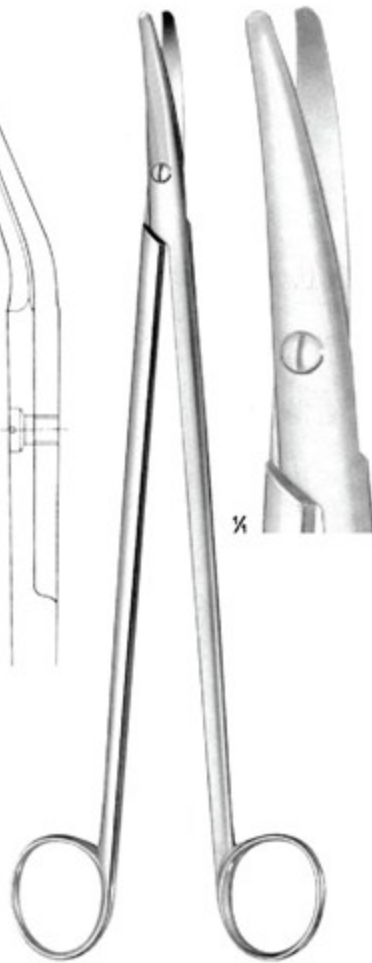

WELLER
 TBI 04-1374-28
 28 cm/11"
 Dissecting scissors
 heavy pattern

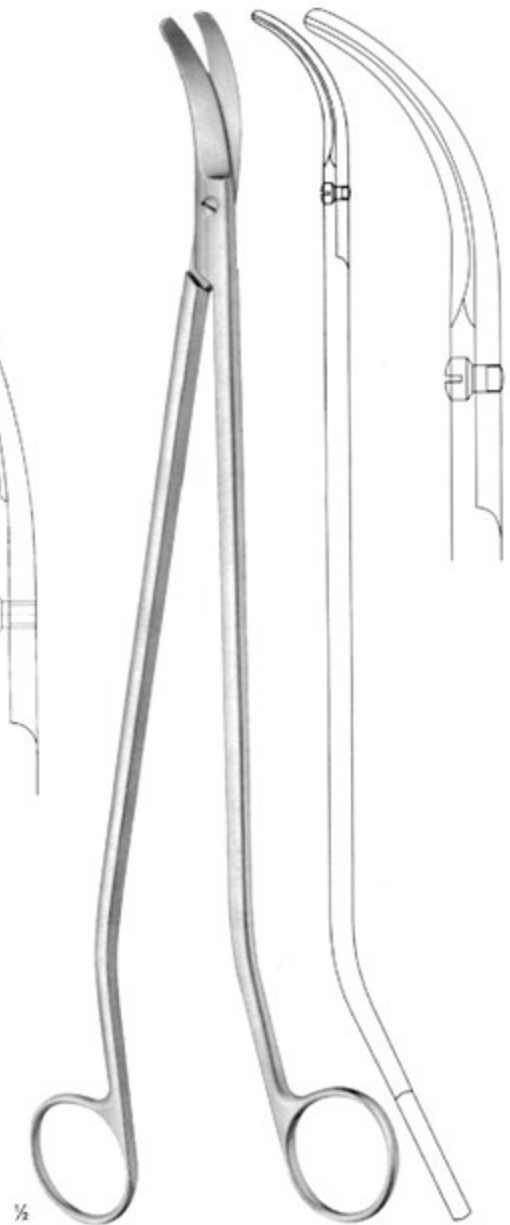

MULLER
 TBI 04-1375-32
 32.5 cm/12 3/4"



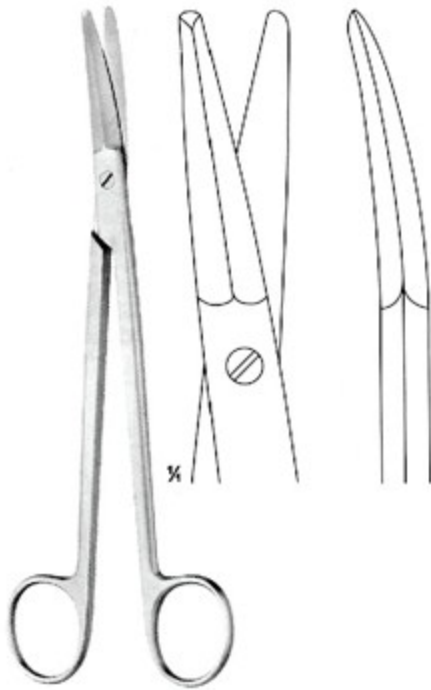

BOETTCHER
 TBI 04-1376-18
 18 cm/7 1/4"

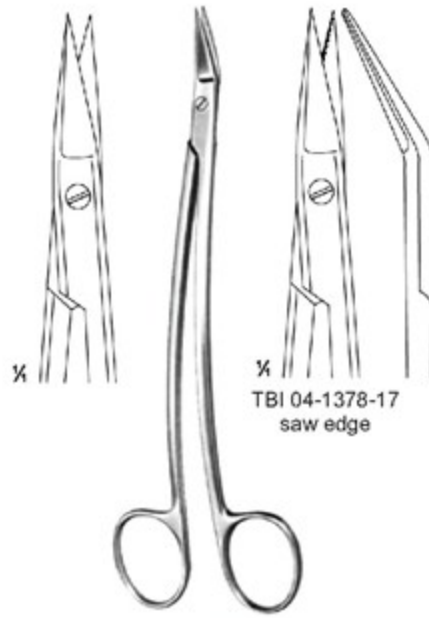

DEAN
 TBI 04-1377-17
 17 cm/6 3/4"

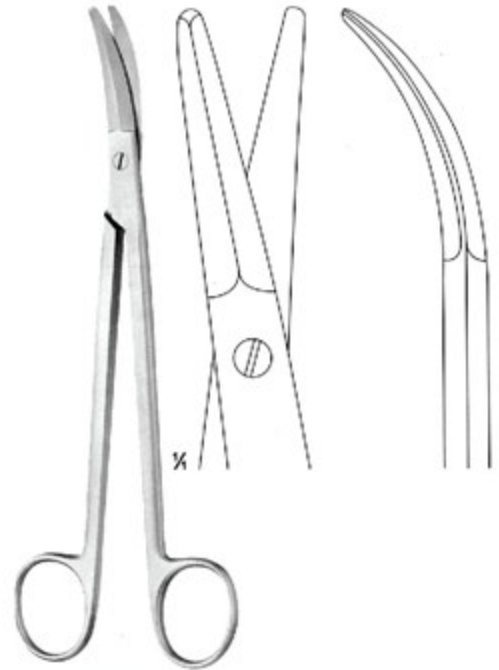

PRINCE
 TBI 04-1379-17
 17.5 cm/6 7/8"



HEYMANN
 TBI 04-1380-18
 18 cm/7 1/4"



COTTLE
 TBI 04-1381-16
 16 cm/6 1/4"



FOMON
 TBI 04-1382-15
 15 cm/5 7/8"



BRAUN-STADLER
 TBI 04-1383-14
 14.5 cm/5 3/4"

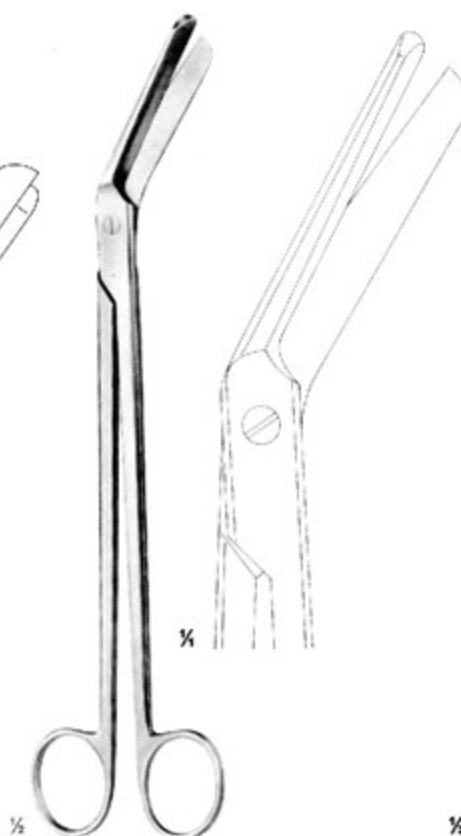

BRAUN-STADLER
 TBI 04-1384-22
 22 cm/8 1/2"

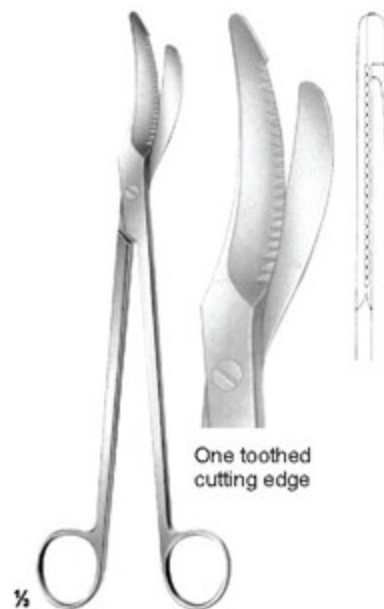

TBI 04-1385-24
 Episiotomy Scissors
 24 cm/9 1/2"

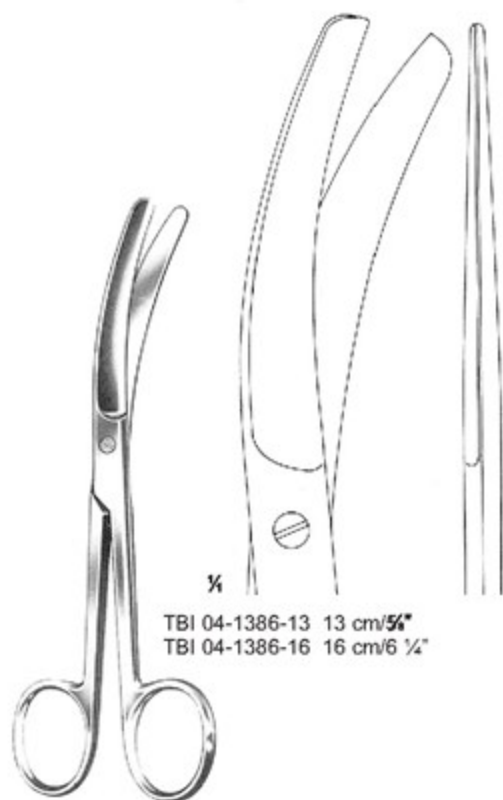

TBI 04-1386-13 13 cm/5 1/8"
 TBI 04-1386-16 16 cm/6 1/4"

BUSCH

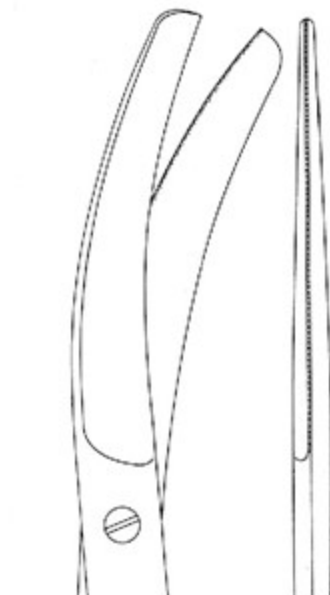

TBI 04-1387-13 13 cm/5 1/8"
 TBI 04-1387-16 16 cm/6 1/4"
 One tooth cutting edge

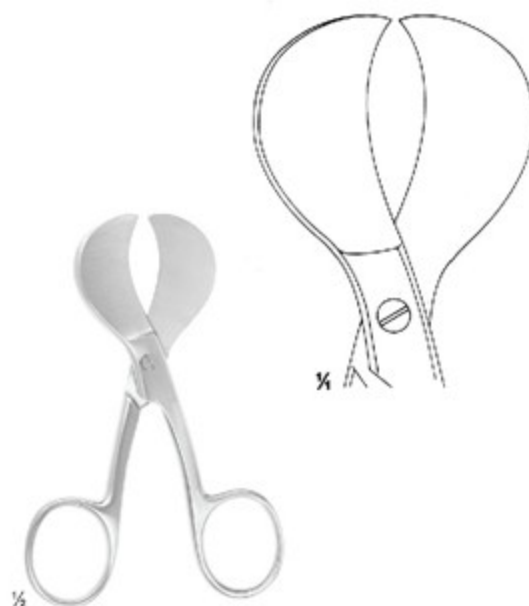

MOD. USA
 TBI 04-1388-10
 10.5 cm/4 1/8"



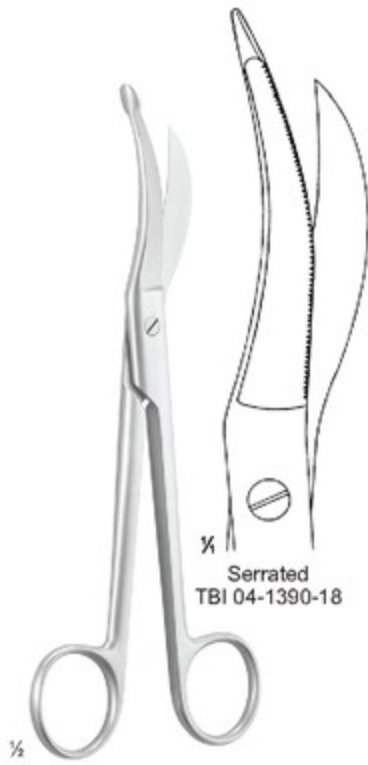

WALDMANN
TBI 04-1389-18
18 cm/7 1/8"
Non-Serrated

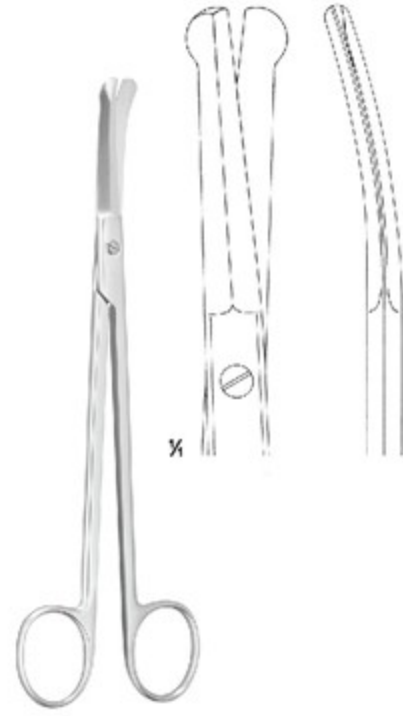

GOOD
TBI 04-1391-19
19 cm/7 1/2"



TBI 04-1392-20
20 cm/7 7/8"
straight



TBI 04-1393-20
20 cm/7 7/8"
curved



TBI 04-1394-23 23 cm/9"
TBI 04-1394-25 25 cm/9 7/8"
Straight



TBI 04-1395-23
23 cm/9"
curved

SCISSORS



SIMS-SIEBOLD
 straight
 TBI 04-1396-24
 24 cm/9 1/2"



SIMS-SIEBOLD
 S-Shaped
 TBI 04-1397-24
 24 cm/9 1/2"

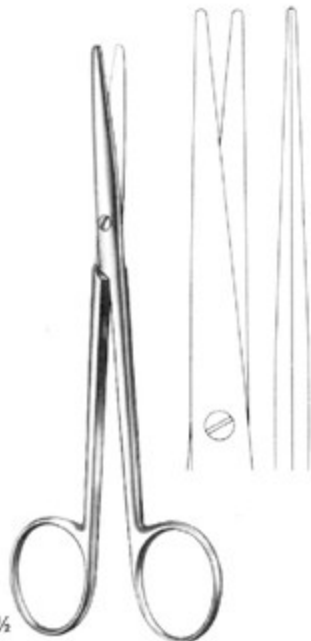
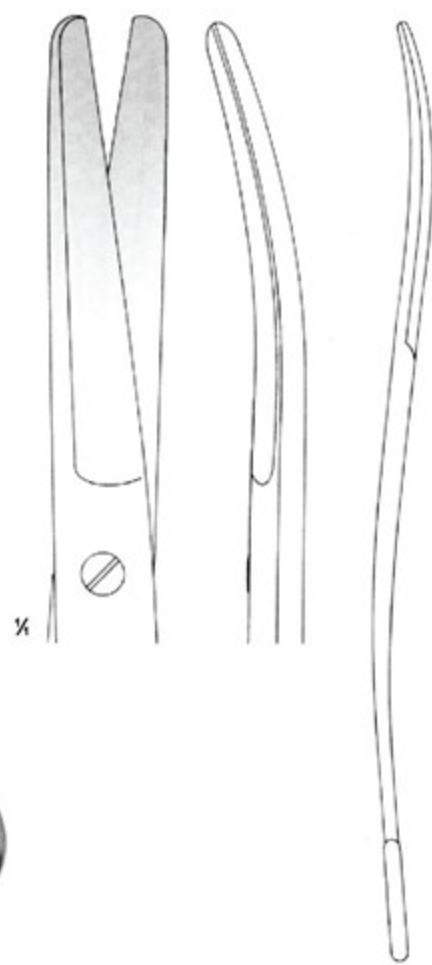

LEXER-FINO
 TBI 04-1398-16
 16 cm/6 1/4"
 Straight

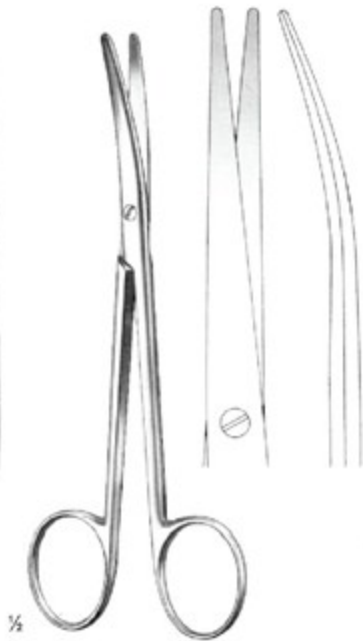

LEXER-FINO
 TBI 04-1399-16
 16 cm/6 1/4"
 Curved



METZENBAUM-FINO
 TBI 04-1400-14
 14.5 cm/5 3/4"
 Straight
 Blunt/Blunt



METZENBAUM-FINO
 TBI 04-1401-14
 14.5 cm/5 3/4"
 Curved
 Blunt/Blunt





METZENBAUM-FINO
 TBI 04-1402-14
 14.5 cm/5 3/4"
 Straight
 Sharp/Sharp

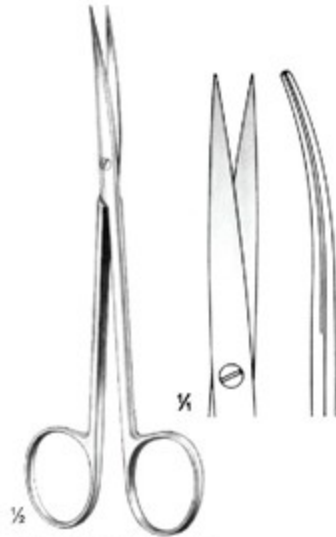

METZENBAUM-FINO
 TBI 04-1403-14
 14.5 cm/5 3/4"
 Curved
 Sharp/Sharp

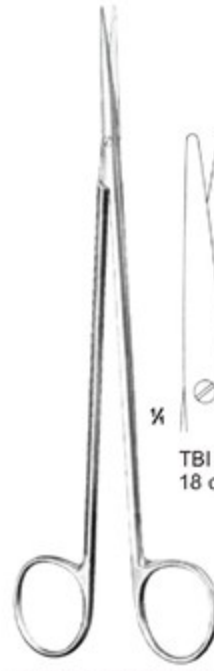

TBI 04-1404-18
 18 cm/7 1/4"



TBI 04-1404-20
 20 cm/7 7/8"



TBI 04-1404-23
 23 cm/9"

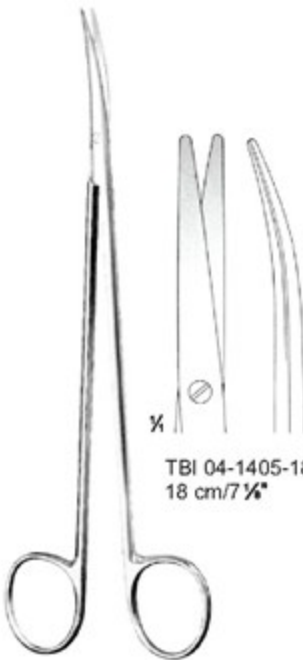

TBI 04-1405-18
 18 cm/7 1/4"



TBI 04-1405-20
 20 cm/7 7/8"



TBI 04-1405-23
 23 cm/9"



TBI 04-1406-18
 18 cm/7 1/4"



TBI 04-1406-20
 20 cm/7 7/8"



TBI 04-1406-23
 23 cm/9"

METZENBAUM-FINO

METZENBAUM-FINO
 S-SHAPED

Ligature Scissors, Nail Splitting Scissors

EN

Ligaturscheren, Nagelschere

DE

Tijeras para ligaduras, Tijeras de uñas Splitting

ES

SCISSORS



SPENCER
TBI 04-1407-09 9 cm/3 1/2"
TBI 04-1407-10 10.5 cm/4 1/4"
TBI 04-1407-13 13 cm/5 1/8"

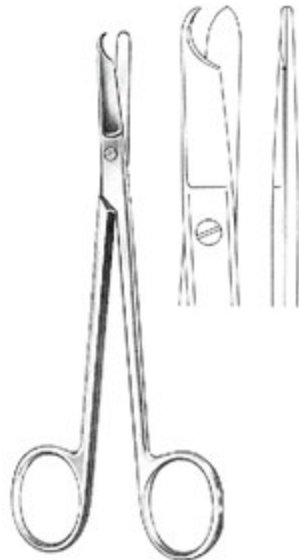

LITTAUER
TBI 04-1408-14
14 cm/5 1/2"

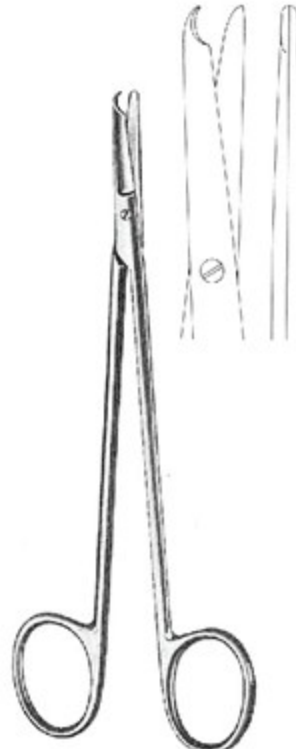

BUCK
TBI 04-1409-14
14.5 cm/5 3/4"

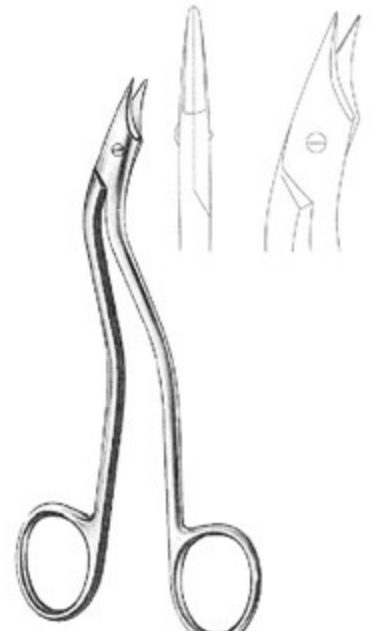

HEATH
TBI 04-1410-15
15 cm/5 7/8"



SCHOEMAKER-LOTH
TBI 04-1411-13
13 cm/5 1/8"

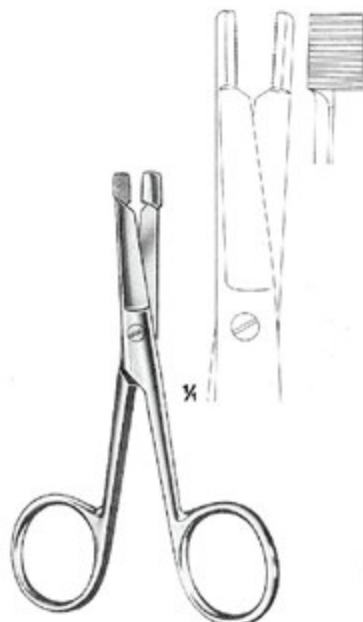

EISELSBERG
TBI 04-1412-12
12 cm/4 3/4"

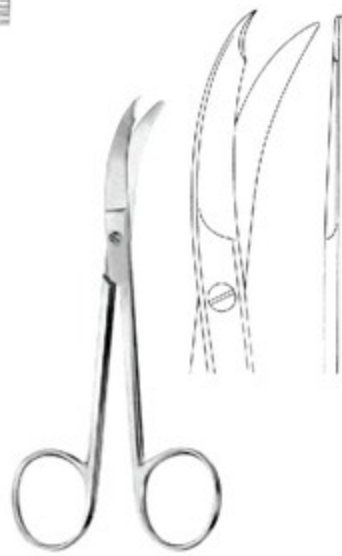

NORTHBENT
TBI 04-1413-09 9 cm/3 1/2"
TBI 04-1413-12 12.5 cm/4 7/8"

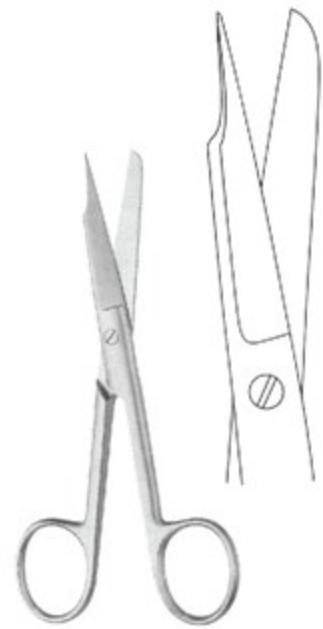

NAIL SPLITTING SCISSORS
TBI 04-1414-13 13 cm/5 1/8"
TBI 04-1414-15 15 cm/5 7/8"



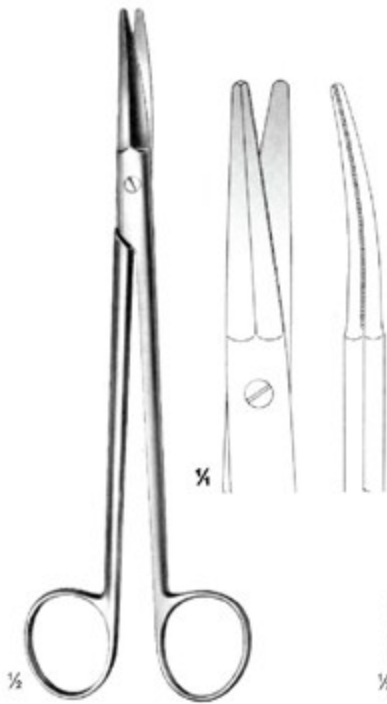

KAYE (TOOTHED)
 TBI 04-1415-18
 18.5 cm/7 1/4"

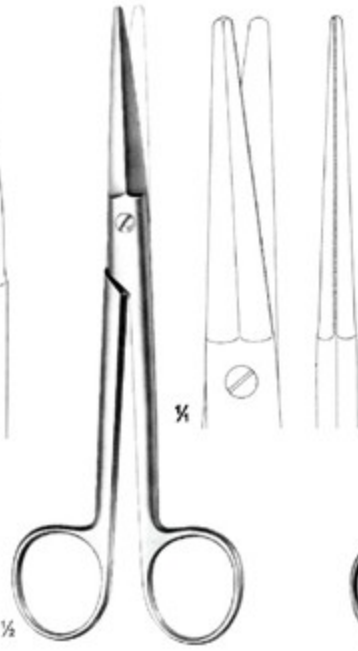

ASTON (TOOTHED)
 TBI 04-1416-17
 17 cm/6 3/4"

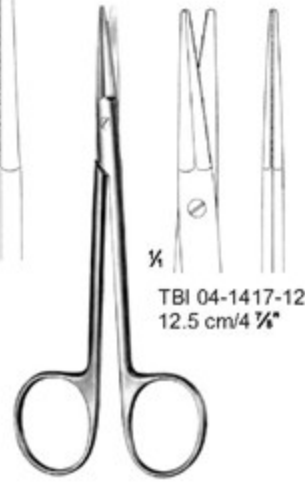

TBI 04-1417-12
 12.5 cm/4 3/4"

GORNEY (TOOTHED)

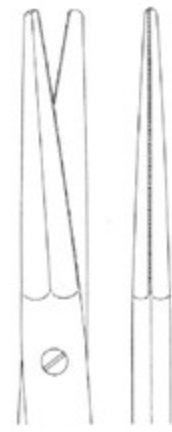

TBI 04-1417-19
 19.5 cm/7 1/2"

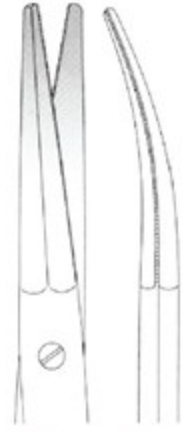

TBI 04-1418-19
 19.5 cm/7 1/2"

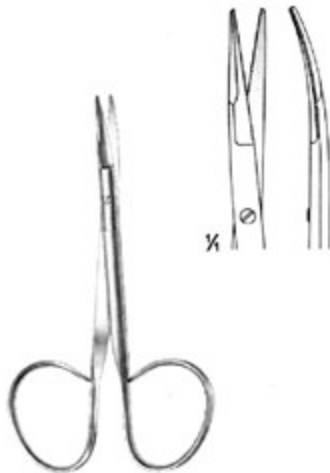

KAYE
 TBI 04-1419-11
 11 cm/4 3/8"

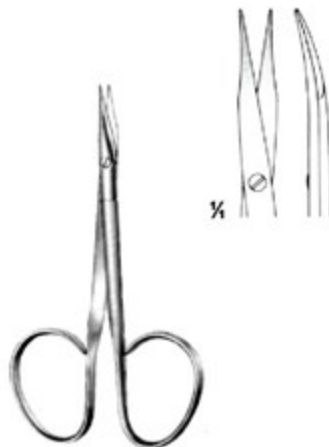

SALYER
 TBI 04-1420-10
 10 cm/3 3/4"



SALYER
 TBI 04-1421-09
 9.5 cm/3 3/8"

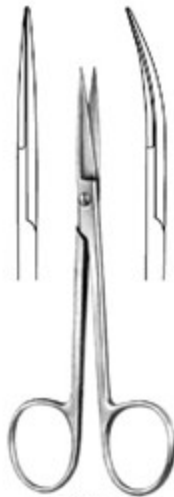

IRIS

	Straight	Curved
9 cm/3 1/2"	TBI 04-1422-09	TBI 04-1423-09
10.5 cm/4 1/4"	TBI 04-1422-10	TBI 04-1423-10
11.5 cm/4 1/2"	TBI 04-1422-11	TBI 04-1423-11



IRIS-FINE

TBI 04-1424-11
11.5 cm/4 1/2"



IRIS-FINE

TBI 04-1425-11
11.5 cm/4 1/2"
angled

Pointed



curved
TBI 04-1427-11

Blunt



straight
TBI 04-1428-11

straight
TBI 04-1426-11

curved
TBI 04-1429-11



STEVENS-TENOTOMY
11.5 cm/4 1/2"

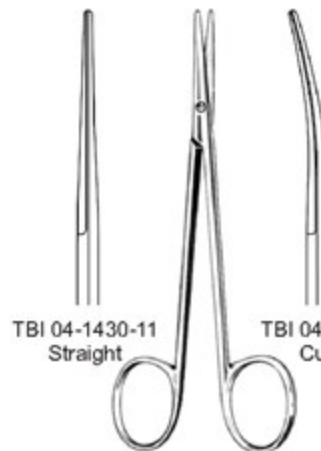

TBI 04-1430-11
Straight

TBI 04-1431-11
Curved

STRABISMUS
11.5 cm/4 1/2"



ENUCLEATION
TBI 04-1432-11
11 cm/4 3/8"



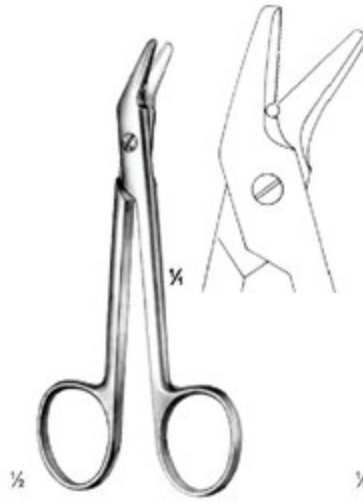

UNIVERSAL
TBI 04-1433-12
12 cm/4 3/4"
one saw edge



TBI 04-1434-10
10 cm/3 3/4"
saw edge



BEEBEE
10.5 cm/4 1/4"

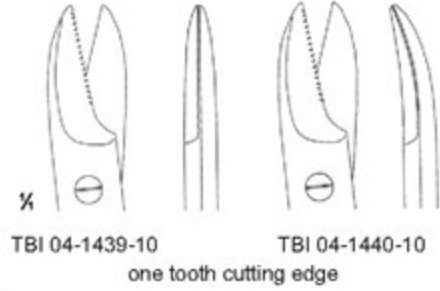

TBI 04-1439-10
TBI 04-1440-10
one tooth cutting edge



TBI 04-1435-10 Blunt TBI 04-1436-10 TBI 04-1437-10 Sharp TBI 04-1438-10



TBI 04-1441-12
12 cm/4 3/4"
saw edge



TBI 04-1442-10
10.5 cm/4 1/4"
saw edge



TBI 04-1443-15
15.5 cm/6 1/4"
saw edge



HARVEY
TBI 04-1444-12
12.5 cm/4 3/4"



12 cm/4 3/4"



TBI 04-1445-12
 Straight
 Sharp/Blunt



TBI 04-1446-12
 Straight
 Sharp/Sharp



TBI 04-1447-12
 Curved
 Sharp/Blunt



TBI 04-1448-12
 Curved
 Sharp/Sharp

Fine Scissors

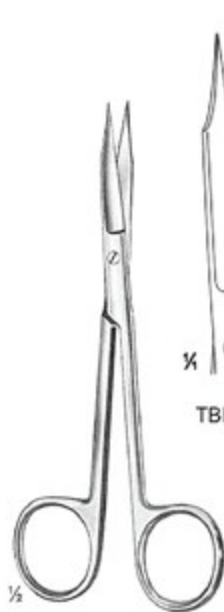

GOLDMANN-FOX
 13 cm/5 1/8"



TBI 04-1449-13
 Straight



TBI 04-1450-13
 Curved



TBI 04-1451-13
 Straight



TBI 04-1452-13
 Curved

Toothed Blades



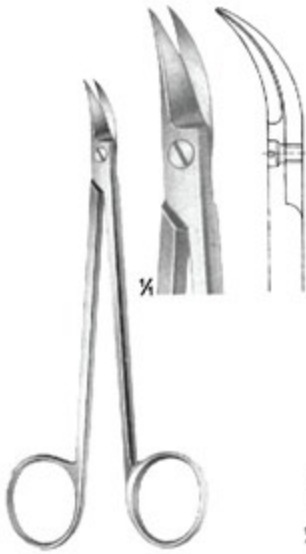

QUINBY
TBI 04-1453-12
12.5 cm/4 1/4"



NEUMANN
TBI 04-1454-12
12 cm/4 3/4"



TBI 04-1455-08
8 cm/3 1/4"
delicate

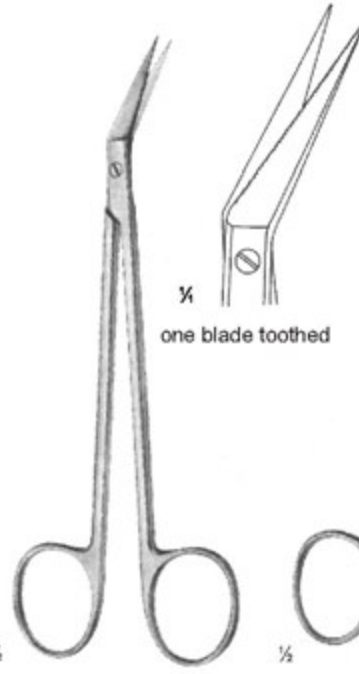

LOCKLIN
TBI 04-1456-16
16 cm/6 1/4"

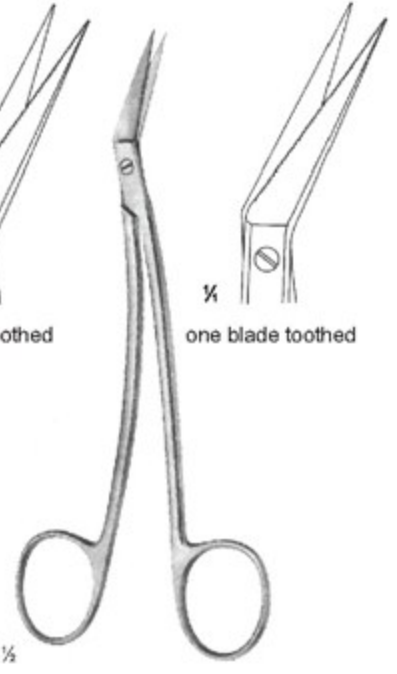

LOCKLIN
TBI 04-1457-16
16 cm/6 1/4"

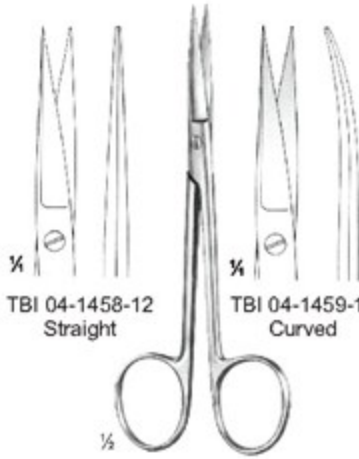

TBI 04-1458-12
Straight

WAGNER
12 cm/4 3/4"

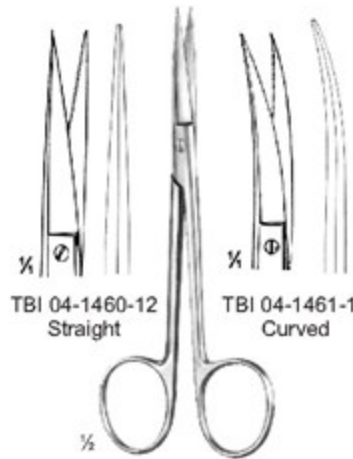

TBI 04-1459-12
Curved

WAGNER
12 cm/4 3/4"
Saw edge

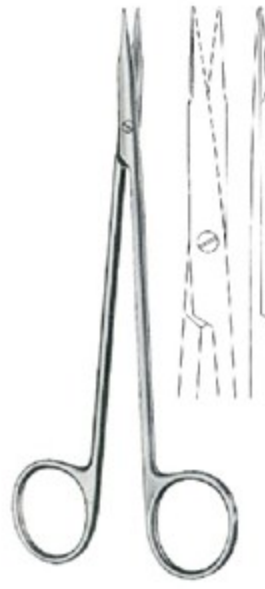

REYNOLDS
Straight
TBI 04-1462-14 14.5 cm/5 3/4"
TBI 04-1462-15 15.5 cm/6"
TBI 04-1462-17 17.5 cm/6 7/8"
TBI 04-1462-18 18.0 cm/7 1/8"



Curved
TBI 04-1463-14
TBI 04-1463-15
TBI 04-1463-17
TBI 04-1463-18



SCHUMACHER
 TBI 04-1464-16
 16 cm/6 1/4"



LANDOLT
 TBI 04-1465-12
 12.5 cm/4 7/8"



LANDOLT
 TBI 04-1466-12
 12.5 cm/4 7/8"

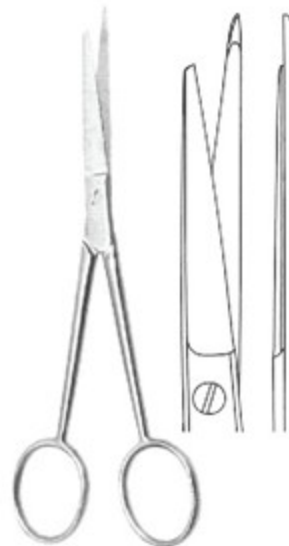

TBI 04-1467-14
 14.5 cm/5 7/8"



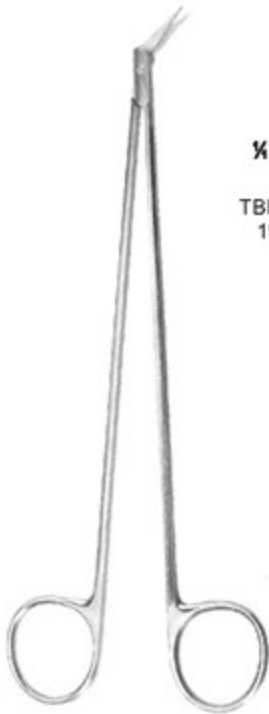

DIETHRICH



25°
 TBI 04-1468-19
 19 cm/7 1/2"



45°
 TBI 04-1468-18
 18 cm/7 1/8"



60°
 TBI 04-1468-17
 17.5 cm/6 7/8"



90°
 TBI 04-1469-17
 17.5 cm/6 7/8"



125°
 TBI 04-1470-17
 17.5 cm/6 7/8"



MICRO-HEGEMANN
 19 cm/7 1/2"



25°
 TBI 04-1471-19



45°
 TBI 04-1472-19



60°
 TBI 04-1473-19



90°
 TBI 04-1474-19



125°
 TBI 04-1475-19

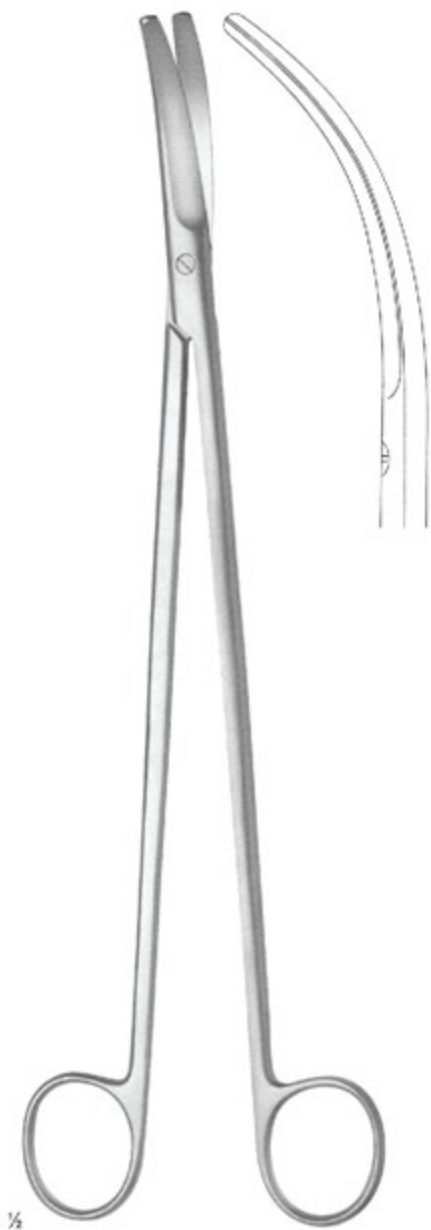

RECTAL
 TBI 04-1476-32
 32.5 cm/12 3/4"

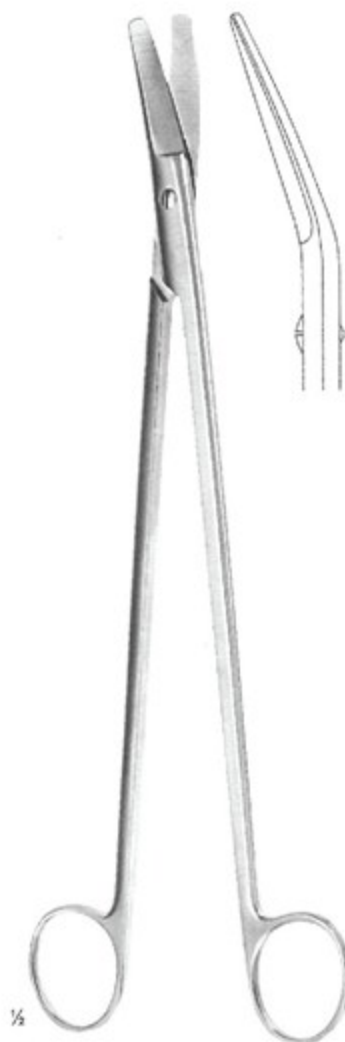

FINOCHIETTO
 TBI 04-1477-27
 27 cm/10 1/2"





TROUTMAN
TBI 04-1478-10
10 cm/4"



TROUTMAN
TBI 04-1479-10
10 cm/4"



KATZIN-BARRAQUER
TBI 04-1480-10
10 cm/4"



KATZIN-BARRAQUER
TBI 04-1481-10
10 cm/4"



KATZIN
TBI 04-1482-10
10 cm/4"



KATZIN
TBI 04-1483-10
10 cm/4"



WESTCOTT
TBI 04-1484-11
11 cm/4½"



WESTCOTT
TBI 04-1485-11
11 cm/4½"



WESTCOTT
TBI 04-1486-11
11 cm/4½"

SCISSORS

Micro Scissors — EN
 Mikroscheren — DE
 Micro-Tijeras — ES



TBI 04-1487-10
10 cm/4"



TBI 04-1488-10
10 cm/4"



CASTROVIEJO
TBI 04-1489-10
10 cm/4"



CASTROVIEJO
TBI 04-1490-10
10 cm/4"



AEBLI
TBI 04-1491-10
10 cm/4"



CASTROVIEJO
TBI 04-1492-10
10 cm/4"



CASTROVIEJO
TBI 04-1493-10
10 cm/4"



TROUTMAN-BARRAQUER
TBI 04-1494-10
10 cm/4"

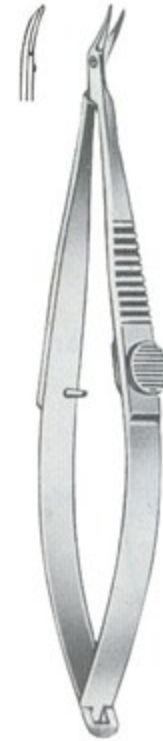

TROUTMAN-BARRAQUER
TBI 04-1495-10
10 cm/4"





Saw Edge

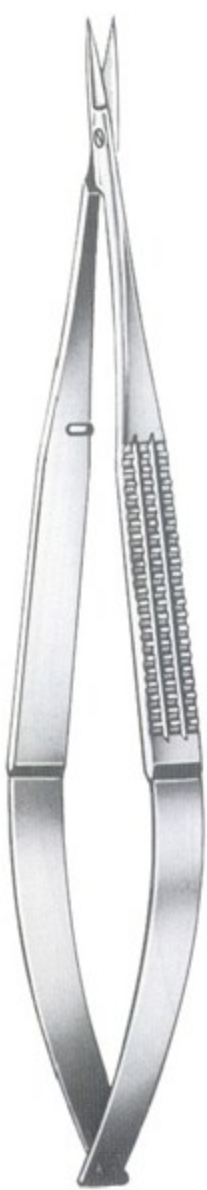

Straight
 TBI 04-1504-16
 16cm/6¼"

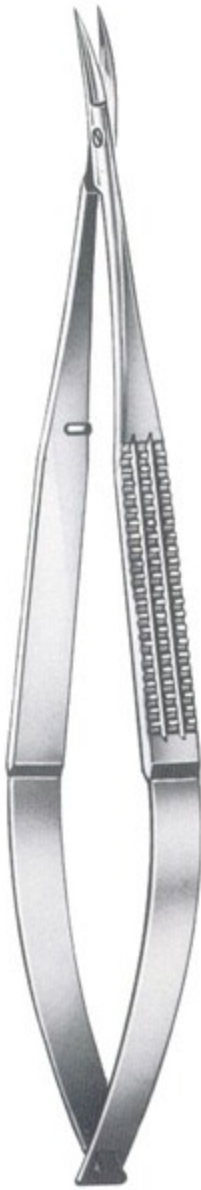

Curved
 TBI 04-1505-16
 16cm/6¼"



Straight
 TBI 04-1506-16
 16cm/6¼"

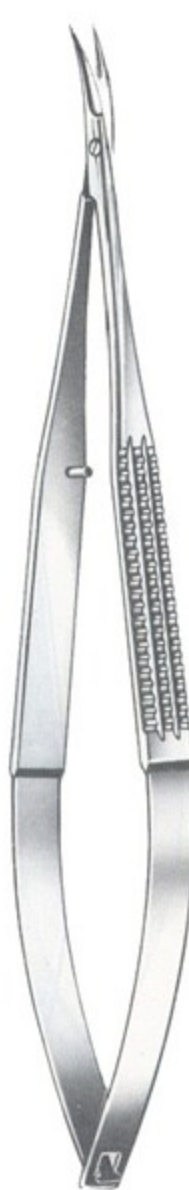

Curved
 TBI 04-1507-16
 16cm/6¼"



MILLESI
Straight
 TBI 04-1508-16
 16cm/6¼"



MILLESI
Curved
 TBI 04-1509-16
 16cm/6¼"



EN Super-Cut Scissors

DE Super-Cut Scheren

ES Tijeras Super-Cut

Page 65 to 74

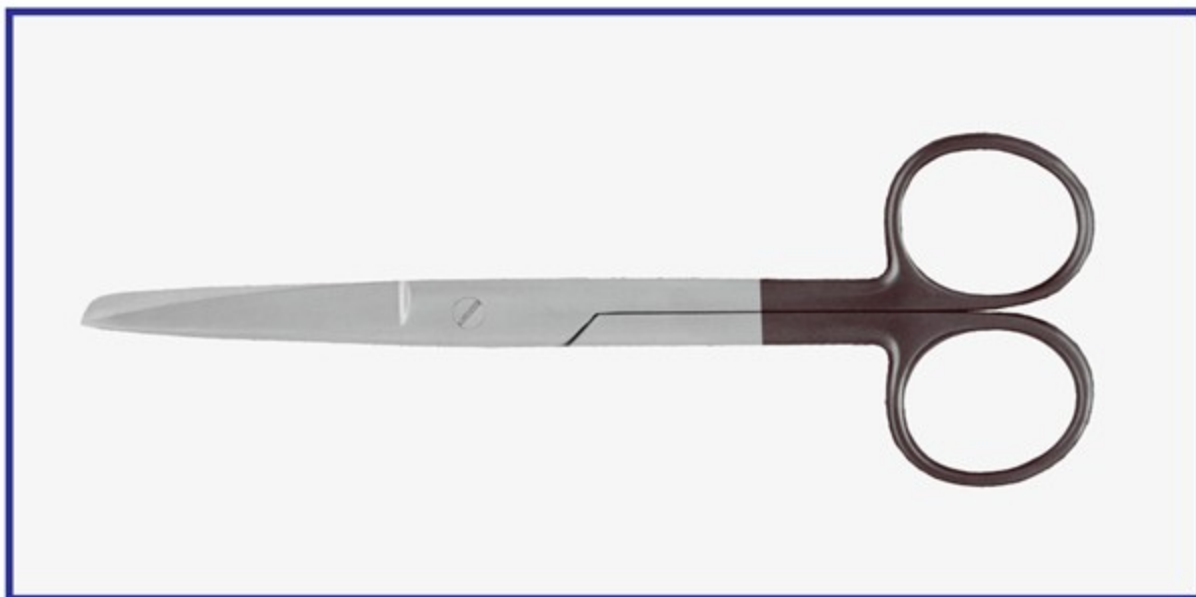

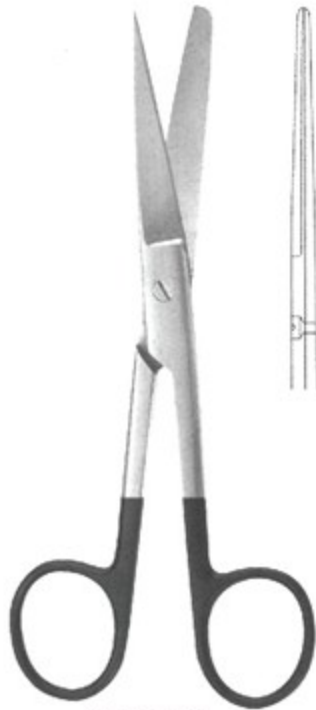

STANDARD
TBI 05-1601-14
14.5 cm/5 ¾"



STANDARD
TBI 05-1602-14
14.5 cm/5 ¾"

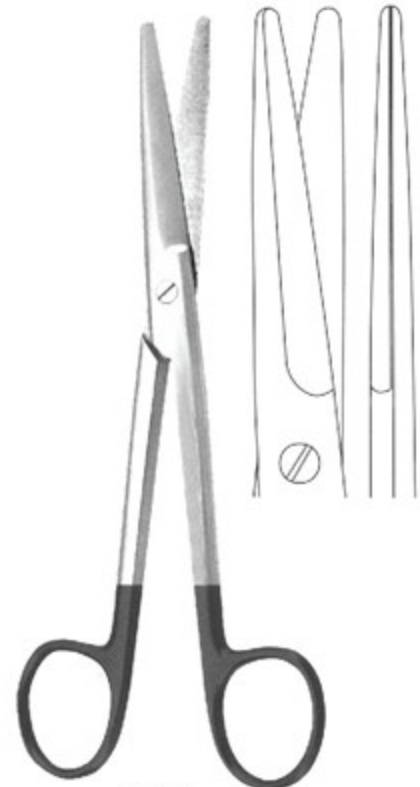

MAYO
TBI 05-1603-14 14.5 cm/5 ¾"
TBI 05-1603-17 17 cm/6 ¾"
TBI 05-1603-23 23 cm/9"

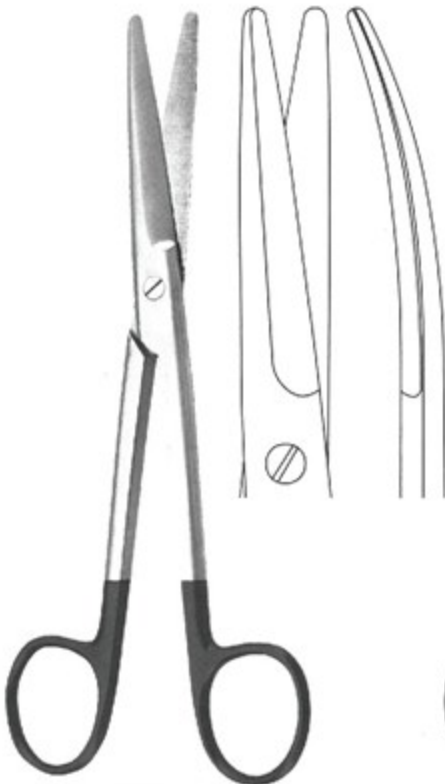

MAYO
TBI 05-1604-14 14.5 cm/5 ¾"
TBI 05-1604-17 17 cm/6 ¾"
TBI 05-1604-23 23 cm/9"

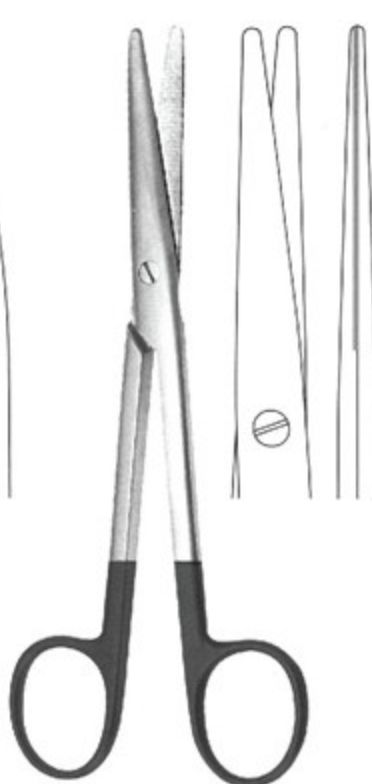

MAYO-STILLE
TBI 05-1605-15 15 cm/5 7/8"
TBI 05-1605-17 17 cm/6 ¾"

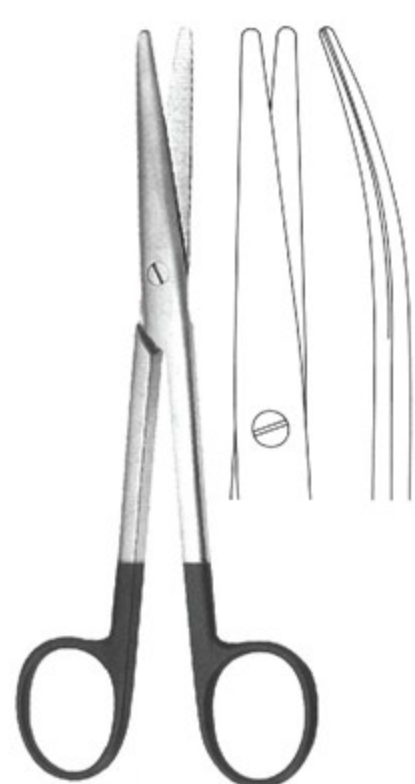

MAYO-STILLE
TBI 05-1606-16 15 cm/5 7/8"
TBI 05-1606-17 17 cm/6 ¾"



METZENBAUM
 11.5 cm/4 1/2"

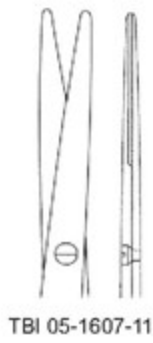

TBI 05-1607-11



TBI 05-1608-11



METZENBAUM
 14.5 cm/5 3/4"

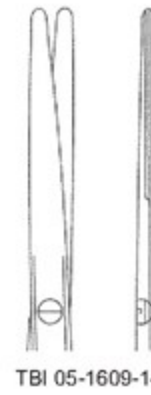

TBI 05-1609-14



TBI 05-1610-14



METZENBAUM-NELSON
 TBI 05-1611-18 18 cm/7 1/8"
 TBI 05-1611-20 20 cm/7 7/8"
 TBI 05-1611-23 23 cm/9"
 TBI 05-1611-26 26 cm/10 1/4"



METZENBAUM-NELSON
 TBI 05-1612-18 18 cm/7 1/8"
 TBI 05-1612-20 20 cm/7 7/8"
 TBI 05-1612-23 23 cm/9"
 TBI 05-1612-26 26 cm/10 1/4"





STRABISMUS
11.5 cm/4 1/2"

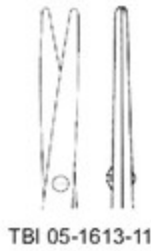

TBI 05-1613-11

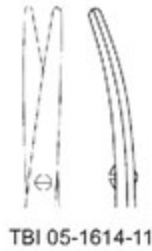

TBI 05-1614-11



LEXER
16 cm/6 1/4"

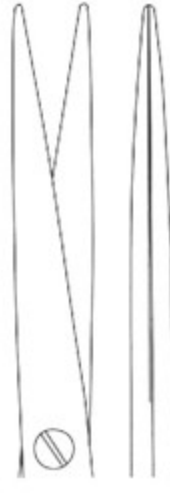

TBI 05-1615-16

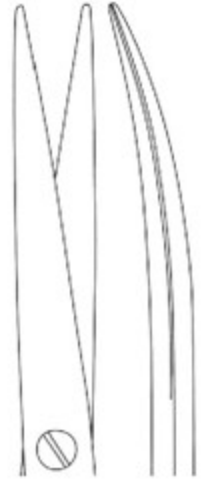

TBI 05-1616-16



METZENBAUM-FINO
14.5 cm/5 3/4"



TBI 05-1617-14



TBI 05-1618-14

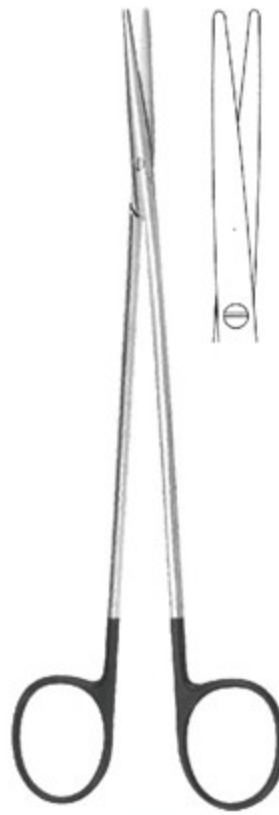

METZENBAUM-FINO
TBI 05-1619-18 18 cm/7 1/8"
TBI 05-1619-20 20 cm/7 7/8"
TBI 05-1619-23 23 cm/9"

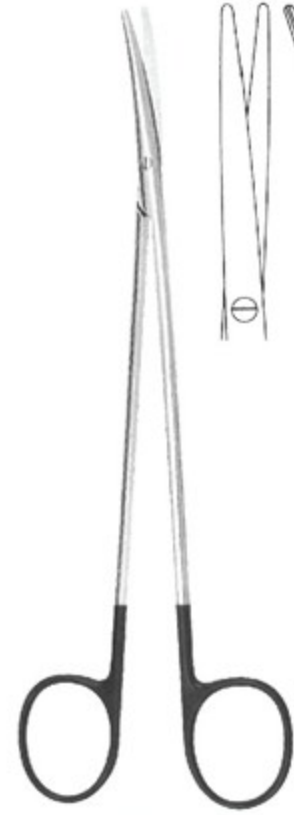

METZENBAUM-FINO
TBI 05-1620-18 18 cm/7 1/8"
TBI 05-1620-20 20 cm/7 7/8"
TBI 05-1620-23 23 cm/9"





TOENNIS-ADSON
 TBI 05-1621-17
 17.5 cm/6 1/4"

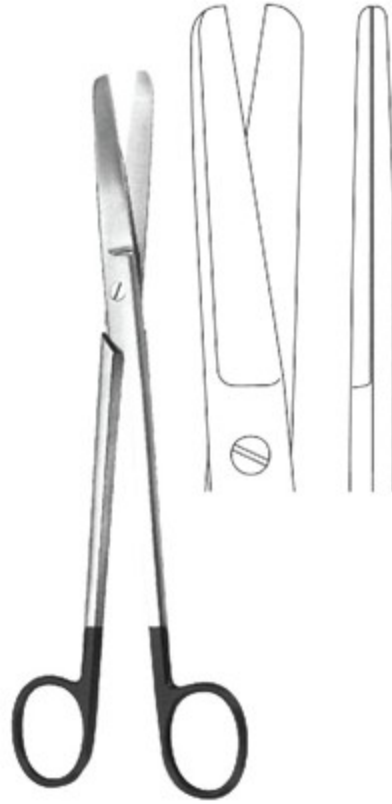

SIMS
 TBI 05-1622-20
 20 cm/7 1/8"



SIMS
 TBI 05-1623-20 20 cm/7 1/8"
 TBI 05-1623-23 23 cm/9"



SIEBOLD
 TBI 05-1624-24
 24 cm/9 1/2"



WALDMANN
 TBI 05-1625-18
 18 cm/7 1/8"



Episiotomy scissors

TBI 05-1626-20
 20 cm/7 1/8"





FOMON
 TBI 05-1627-13
 13.5 cm/5 3/8"



FOMON
 TBI 05-1628-14
 14.5 cm/5 7/8"



COTTLE
 TBI 05-1629-16
 16 cm/6 1/4"



HEYMANN
 TBI 05-1630-18
 18 cm/7 1/8"

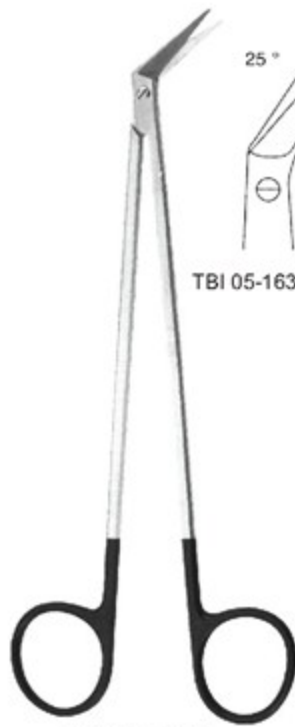

POTTS-SMITH
19 cm/7 1/2"



25°

TBI 05-1631-19

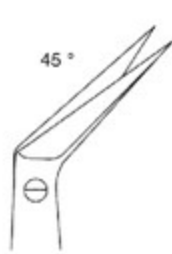

45°

TBI 05-1632-19

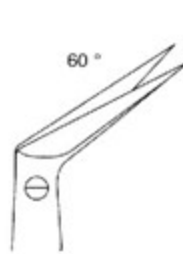

60°

TBI 05-1633-19

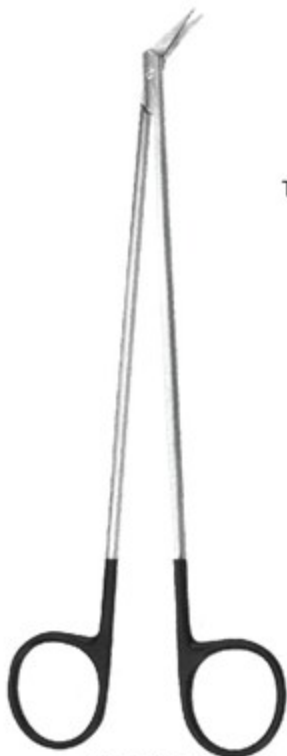

DIETRICH
19 cm/7 1/2"



25°

TBI 05-1634-19



45°

TBI 05-1635-19

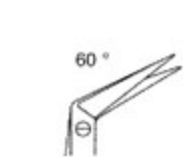

60°

TBI 05-1636-19

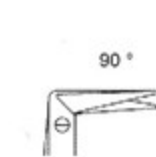

90°

TBI 05-1637-19



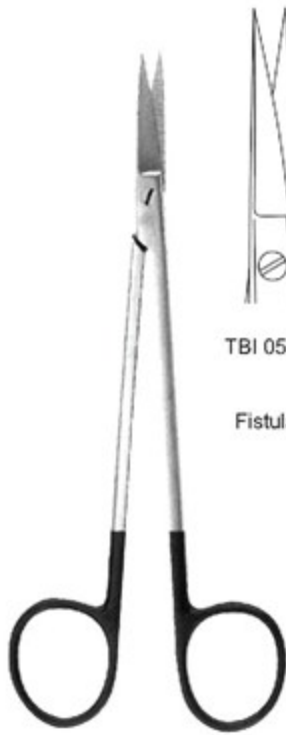

KELLY
16 cm/6 1/4"



TBI 05-1638-16

Fistula scissors

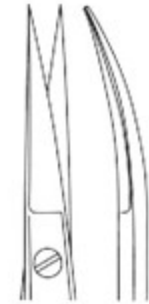

TBI 05-1639-16



JOSEPH
14 cm/5 1/2"



TBI 05-1640-14



TBI 05-1641-14



IRIS
11.5 cm/4 1/2"



TBI 05-1642-11



TBI 05-1643-11



WAGNER
12 cm/4 3/4"



TBI 05-1644-12



TBI 05-1645-12



TBI 05-1646-11

STEVENS
 11.5 cm/4 1/2"



TBI 05-1647-11

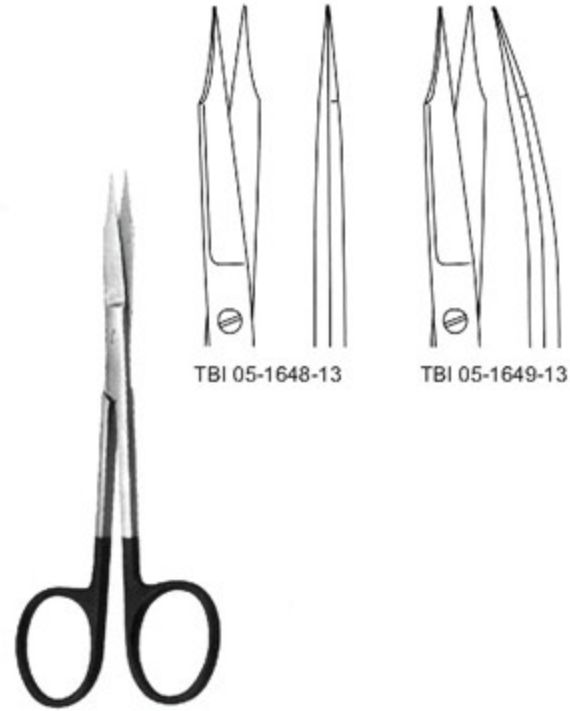

TBI 05-1648-13

TBI 05-1649-13

GOLDMANN-FOX
 13 cm/5 1/8"

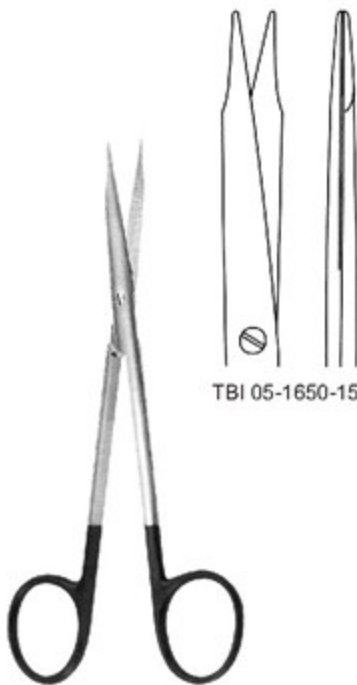

TBI 05-1650-15

REYNOLDS
 15 cm/5 7/8"



TBI 05-1651-15



REYNOLDS
 TBI 05-1652-17
 17.5 cm/6 7/8"





JAMESON
TBI 05-1653-15
15 cm/5 7/8"



PAR-TYPE
12 cm/4 3/4"

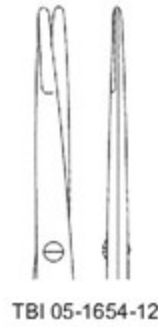

TBI 05-1654-12



TBI 05-1655-12



KAYE FACE LIFT
TBI 05-1656-15 15 cm/5 7/8"
TBI 05-1657-19 19 cm/7 1/2"

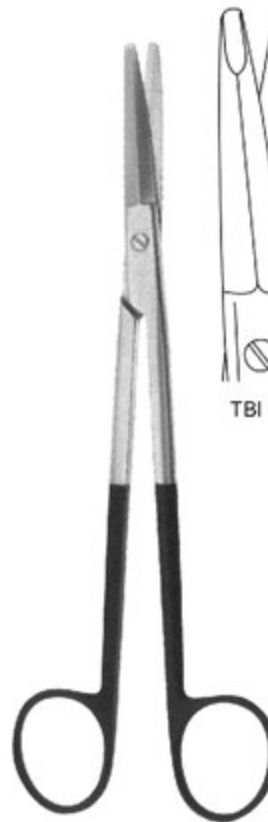

GORNEY
19 cm/7 1/2"



TBI 05-1658-19



TBI 05-1659-19

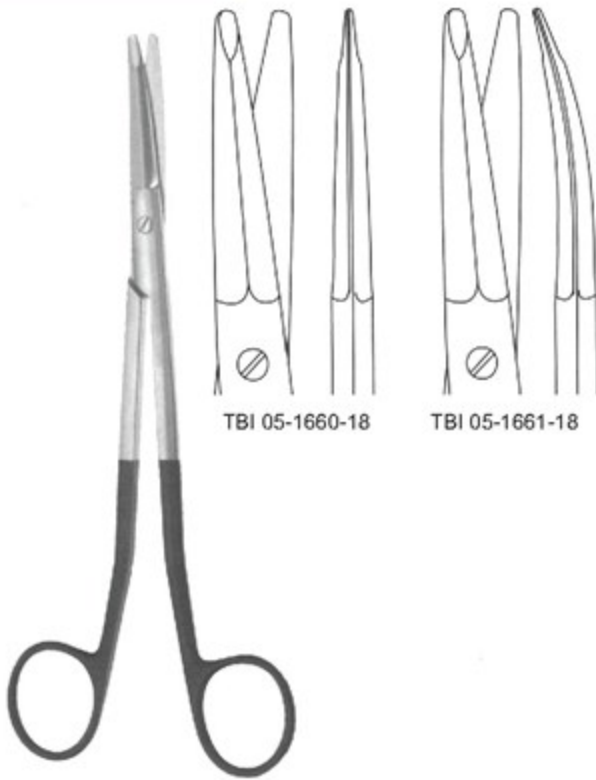

FREEMANN-KAYE
 18 cm/7 1/8"

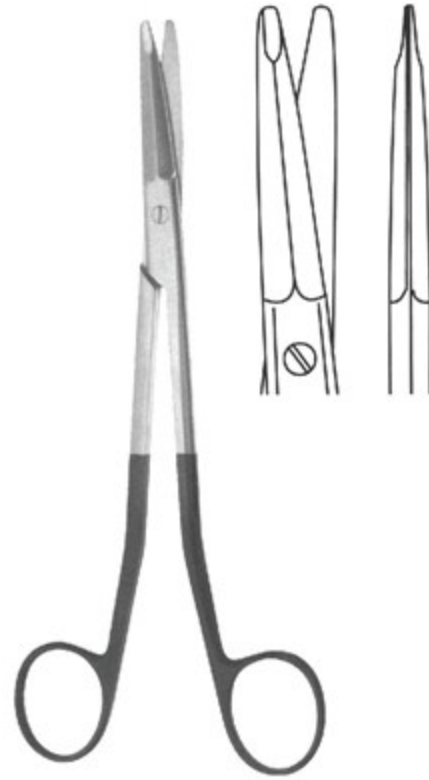

FREEMANN-KAYE
 TBI 05-1662-19 19 cm/7 1/2"
 TBI 05-1662-23 23 cm/9"

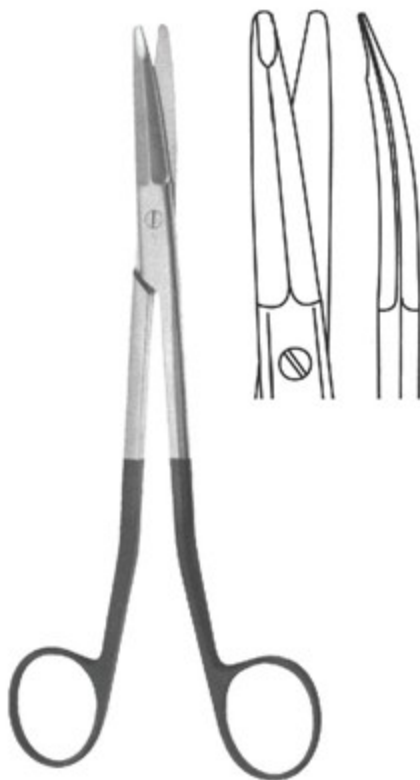

FREEMANN-GORNEY
 TBI 05-1663-19 19 cm/7 1/2"
 TBI 05-1663-23 23 cm/9"



LISTER
 TBI 05-1664-14 14 cm/5 1/2"
 TBI 05-1664-18 18 cm/7 1/8"
 TBI 05-1664-20 20 cm/7 7/8"



EN TC Scissors

DE TC Scheren

ES Tijeras TC

Page 75 to 84

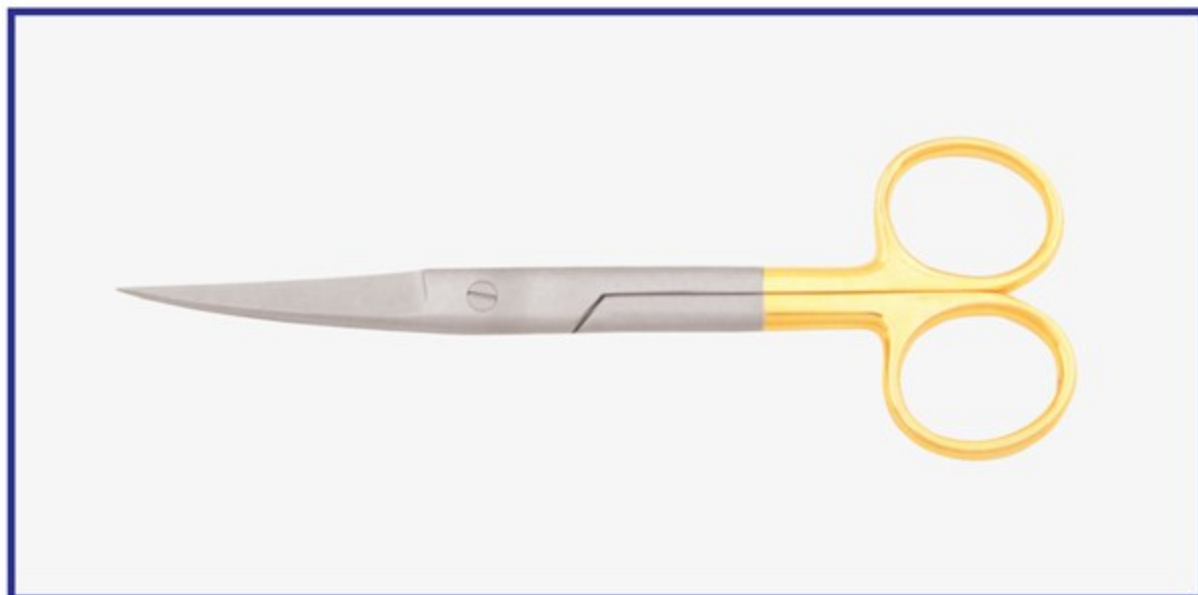

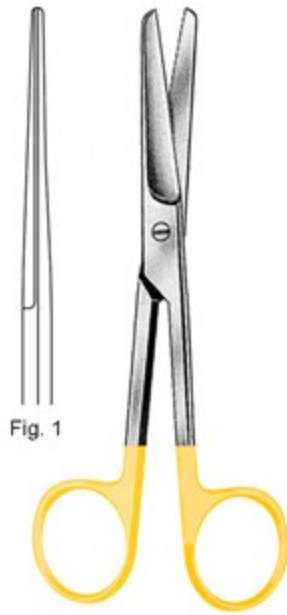

Fig. 1

STANDARD
TBI 06-1801-14
14.5 cm/5 3/4"

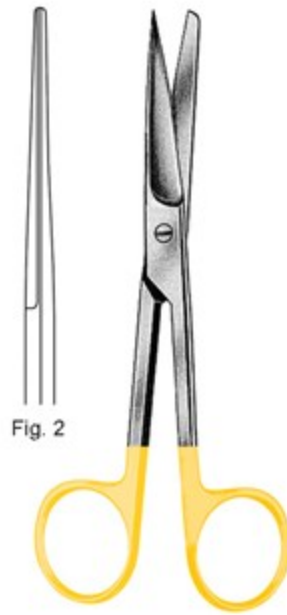

Fig. 2

STANDARD
TBI 06-1802-14
14.5 cm/5 3/4"

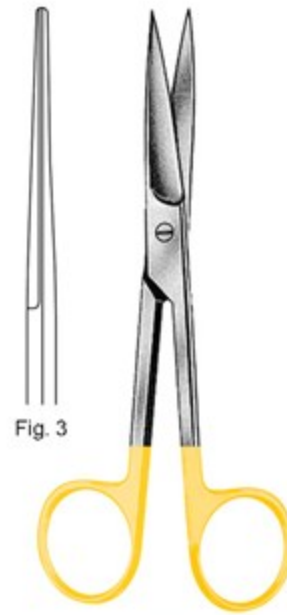

Fig. 3

STANDARD
TBI 06-1803-14
14.5 cm/5 3/4"



Fig. 1

STANDARD
TBI 06-1804-14
14.5 cm/5 3/4"

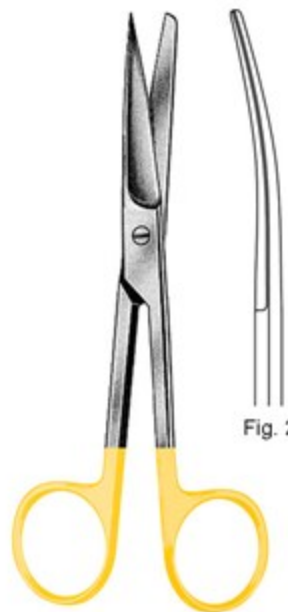

Fig. 2

STANDARD
TBI 06-1805-14
14.5 cm/5 3/4"



Fig. 3

STANDARD
TBI 06-1806-14
14.5 cm/5 3/4"



MAYO-Straight
 TBI 06-1807-14 14.5 cm/5 ¾"
 TBI 06-1807-17 17 cm/6 ¾"
 TBI 06-1807-23 23 cm/9"



MAYO-Curved
 TBI 06-1808-14 14.5 cm/5 ¾"
 TBI 06-1808-17 17 cm/6 ¾"
 TBI 06-1808-23 23 cm/9"



TBI 06-1809-16 TBI 06-1810-16
 ½
MAYO-LEXER
 Dissecting
 16 cm/6 ¼"

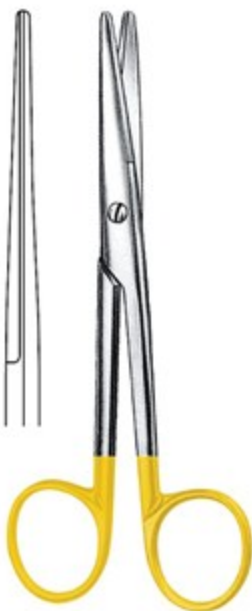

MAYO-STILLE
 TBI 06-1811-14 14.5 cm/5 ¾"
 TBI 06-1811-17 17 cm/6 ¾"



MAYO-STILLE
 TBI 06-1812-14 14.5 cm/5 ¾"
 TBI 06-1812-17 17 cm/6 ¾"

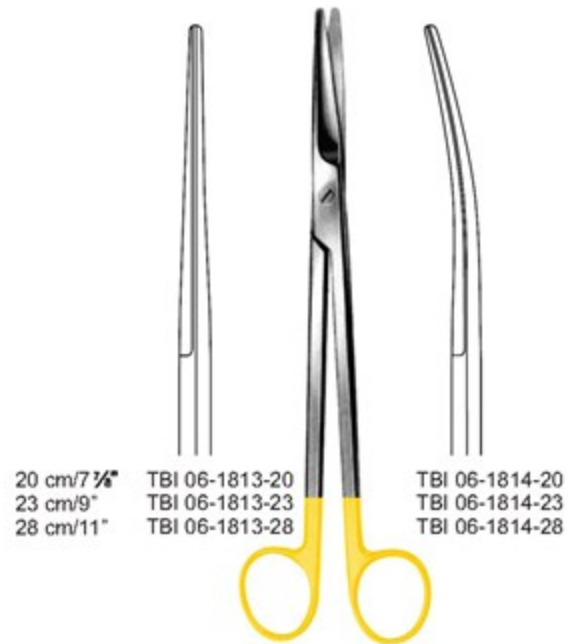

20 cm/7 ¾"
 23 cm/9"
 28 cm/11"
 TBI 06-1813-20
 TBI 06-1813-23
 TBI 06-1813-28
 TBI 06-1814-20
 TBI 06-1814-23
 TBI 06-1814-28
MAYO-HARRINGTON
 Gynecological



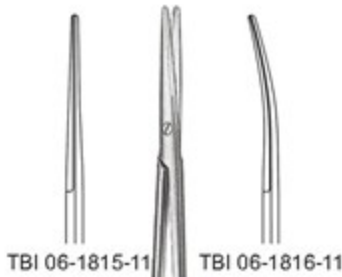

TBI 06-1815-11 TBI 06-1816-11



$\frac{1}{2}$
METZENBAUM
11.5 cm/4 $\frac{1}{2}$ "



TBI 06-1817-14 TBI 06-1818-14



$\frac{1}{2}$
METZENBAUM
14.5 cm/5 $\frac{3}{4}$ "

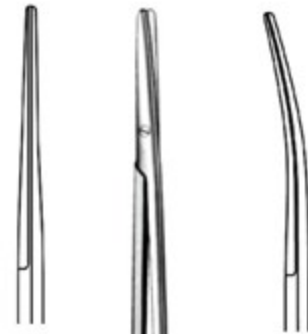

METZENBAUM

	Straight	Curved
TBI 06-1819-18	18 cm/7 $\frac{1}{8}$ "	TBI 06-1820-18
TBI 06-1819-20	20 cm/7 $\frac{7}{8}$ "	TBI 06-1820-20
TBI 06-1819-23	23 cm/9"	TBI 06-1820-23
TBI 06-1819-25	25 cm/9 $\frac{1}{2}$ "	TBI 06-1820-25
TBI 06-1819-28	28 cm/11"	TBI 06-1820-28
TBI 06-1819-30	30 cm/11 $\frac{3}{4}$ "	TBI 06-1820-30



$\frac{1}{2}$
METZENBAUM-Fino
TBI 06-1821-14
14.5 cm/5 $\frac{3}{4}$ "



$\frac{1}{2}$
METZENBAUM-Fino
TBI 06-1822-14
14.5 cm/5 $\frac{3}{4}$ "



$\frac{1}{2}$
METZENBAUM-Fino
TBI 06-1823-14
14.5 cm/5 $\frac{3}{4}$ "

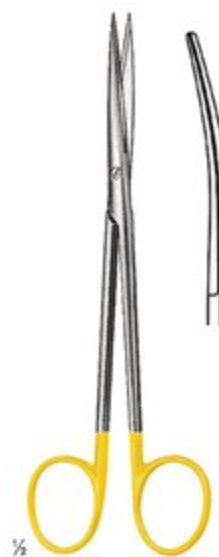

$\frac{1}{2}$
METZENBAUM-Fino
TBI 06-1824-14
14.5 cm/5 $\frac{3}{4}$ "



METZENBAUM-Fino
 TBI 06-1825-18 18 cm/ $\frac{7}{8}$ "
 TBI 06-1825-20 20 cm/ $\frac{7}{8}$ "
 TBI 06-1825-23 23 cm/9"
 TBI 06-1825-25 25 cm/ $\frac{9}{8}$ "
 TBI 06-1825-28 28 cm/11"



METZENBAUM-Fino
 TBI 06-1826-18 18 cm/ $\frac{7}{8}$ "
 TBI 06-1826-20 20 cm/ $\frac{7}{8}$ "
 TBI 06-1826-23 23 cm/9"
 TBI 06-1826-25 25 cm/ $\frac{9}{8}$ "
 TBI 06-1826-28 28 cm/11"



METZENBAUM-Fino
 TBI 06-1827-18 18 cm/ $\frac{7}{8}$ "
 TBI 06-1827-20 20 cm/ $\frac{7}{8}$ "
 TBI 06-1827-23 23 cm/9"
 TBI 06-1827-25 25 cm/ $\frac{9}{8}$ "
 TBI 06-1827-28 28 cm/11"



METZENBAUM-Fino
 TBI 06-1828-18 18 cm/ $\frac{7}{8}$ "
 TBI 06-1828-20 20 cm/ $\frac{7}{8}$ "
 TBI 06-1828-23 23 cm/9"
 TBI 06-1828-25 25 cm/ $\frac{9}{8}$ "
 TBI 06-1828-28 28 cm/11"

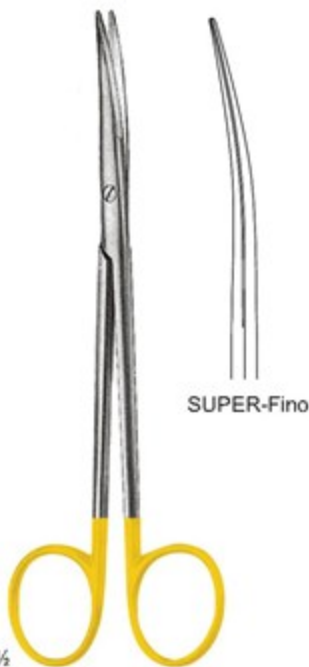

$\frac{1}{2}$
TOENNIS-ADSON
 TBI 06-1829-17
 17.5 cm/6 $\frac{1}{8}$ "

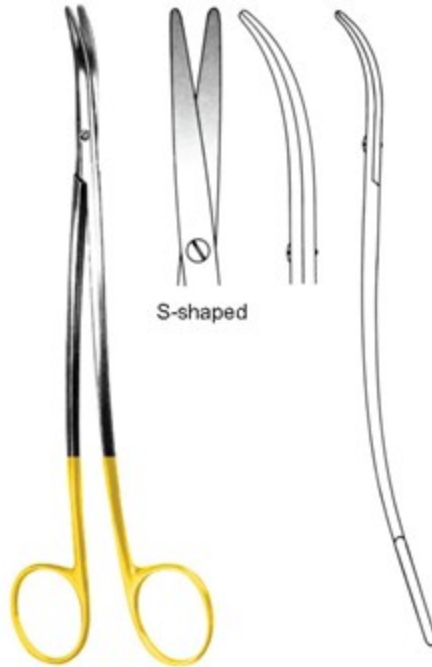

METZENBAUM-Fino
 TBI 06-1830-18 18 cm/ $\frac{7}{8}$ "
 TBI 06-1830-20 20 cm/ $\frac{7}{8}$ "
 TBI 06-1830-23 23 cm/9"

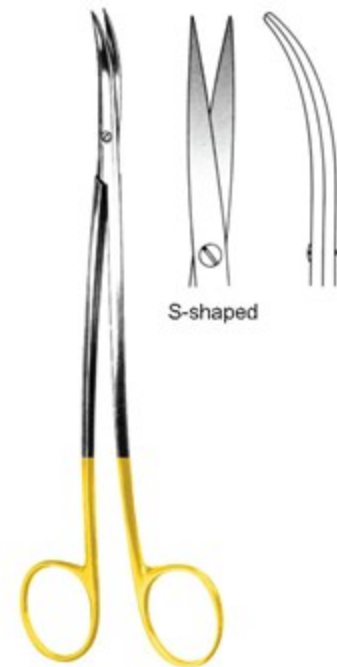

METZENBAUM-Fino
 TBI 06-1831-18 18 cm/ $\frac{7}{8}$ "
 TBI 06-1831-20 20 cm/ $\frac{7}{8}$ "
 TBI 06-1831-23 23 cm/9"



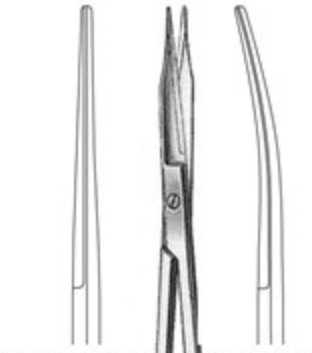

TBI 06-1832-13



GOLDMAN-FOX
13 cm/5 1/8"

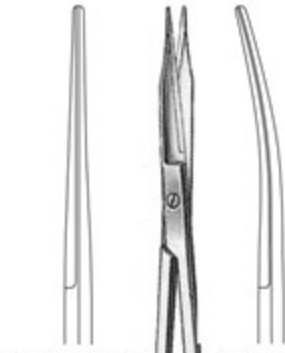

TBI 06-1833-13



GOLDMAN-FOX
Toothed blades
13 cm/5 1/8"



TBI 06-1836-10



KNAPP/LEXER-Baby
Starbismus
10 cm/3 1/4"

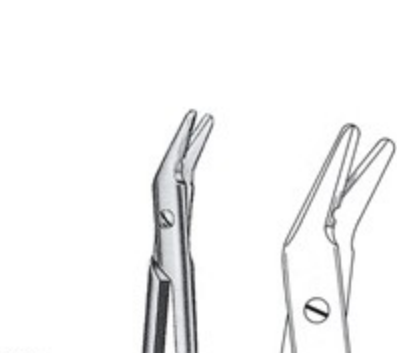

TBI 06-1837-10



UNIVERSAL (Wire Cutting)
TBI 06-1838-12
12 cm/4 3/4"



TBI 06-1839-11



IRIS
11.5 cm/4 1/2"



TBI 06-1840-11



BEEBEE

TBI 06-1841-11
11 cm/4 1/8"
Sharp

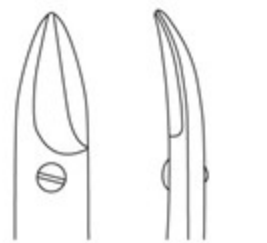

TBI 06-1842-11
11 cm/4 1/8"
Sharp

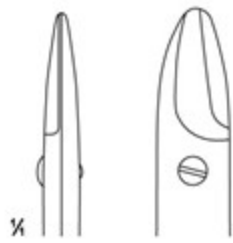

TBI 06-1843-10
10 cm/3 1/8"
Blunt



TBI 06-1844-10
10 cm/3 1/8"
Blunt

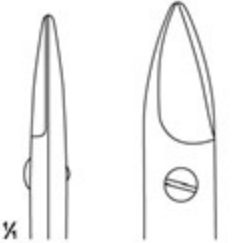

TBI 06-1845-11
11 cm/4 1/4"
Sharp



TBI 06-1846-11
11 cm/4 1/4"
1 Blade serrated

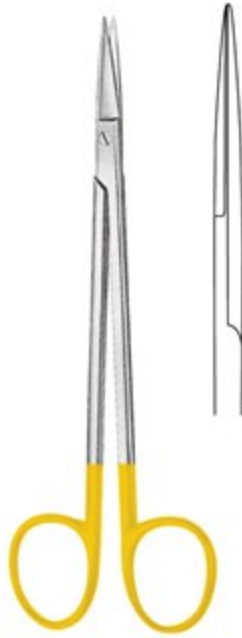

KELLY
 TBI 06-1847-16 16 cm/6 1/4"
 TBI 06-1847-18 18 cm/7 1/8"



KELLY
 TBI 06-1848-16 16 cm/6 1/4"
 TBI 06-1848-18 18 cm/7 1/8"



RAGNELL
 TBI 06-1849-12
 12 cm/4 3/4"



RAGNELL
 TBI 06-1850-12
 12 cm/4 3/4"



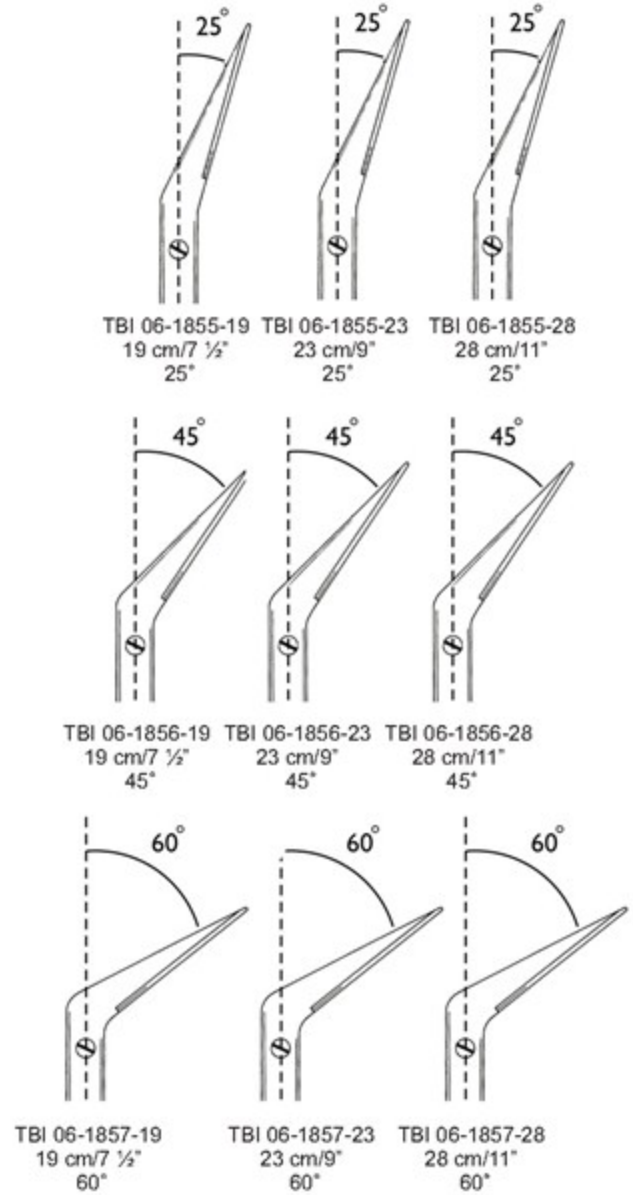
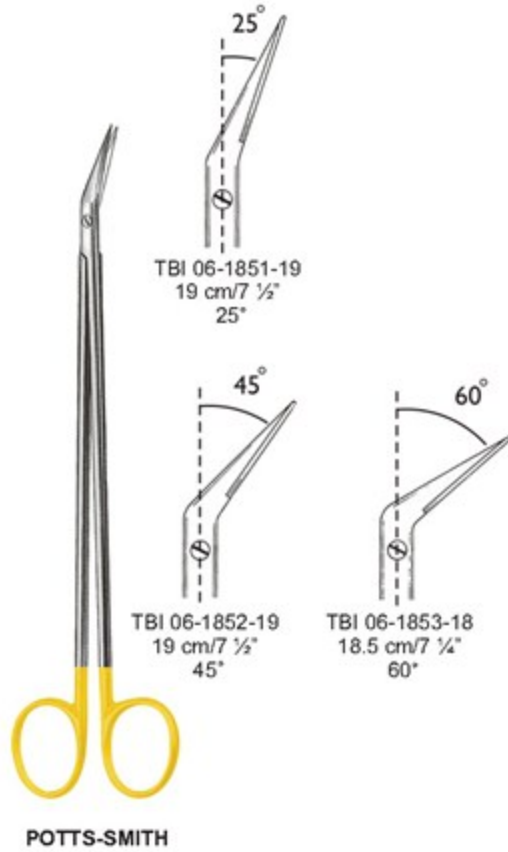



BRUNS-Plaster
 TBI 06-1858-24
 24 cm/9 1/2"



LISTER-Bandage
 TBI 06-1859-18
 18 cm/7 1/8"

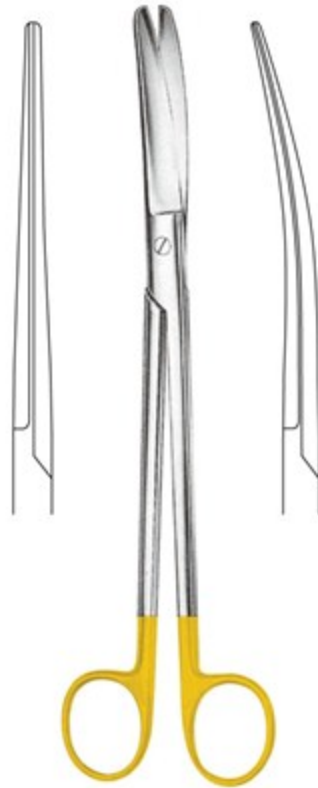

SIMS (Uterine)
 TBI 06-1860-20 20 cm/7 7/8" TBI 06-1861-20
 TBI 06-1860-23 23 cm/9" TBI 06-1861-23





TBI 06-1862-16
16 cm/6 1/4"



TBI 06-1863-16
16 cm/6 1/4"

TC SCISSORS

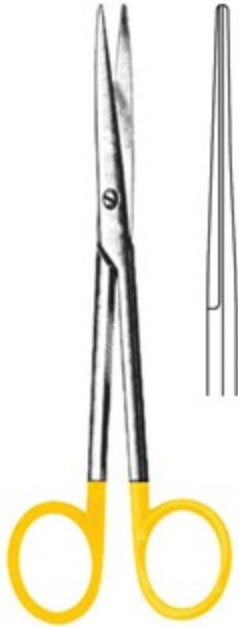

LEXER
TBI 06-1864-16 16 cm/6 1/4"
TBI 06-1864-21 21 cm/8 1/4"

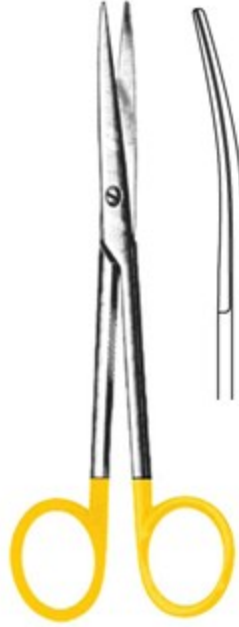

LEXER
TBI 06-1865-16 16 cm/6 1/4"
TBI 06-1865-21 21 cm/8 1/4"



PARAMETRIUM
TBI 06-1866-22 22.5 cm/8 3/4"
TBI 06-1866-23 23 cm/9"



WERTHEIM
TBI 06-1867-22
22.5 cm/8 3/4"



LOCKLIN
TBI 06-1868-16
16 cm/6 1/4"
1 toothed blade



LOCKLIN
TBI 06-1869-16
16 cm/6 1/4"
1 toothed blade



- EN** TC Super-Cut Scissors
- DE** TC Super-Cut Scheren
- ES** Tijeras Super-Cut TC

Page 85 to 86

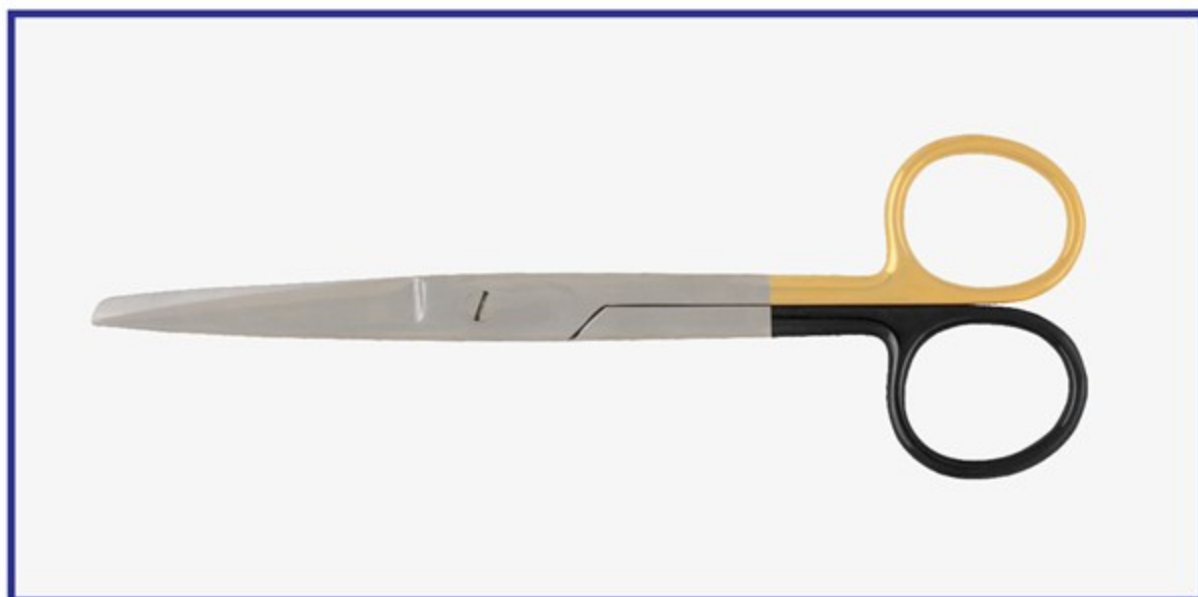



For synthetic suture material
one toothed cutting edge



TBI 07-1901-14
14.5 cm/5 7/8"



TBI 07-1901-18
18 cm/7 1/8"



TBI 07-1901-20
20.5 cm/8 1/8"



TBI 07-1901-23
23 cm/9"



TBI 07-1901-25
25 cm/9 7/8"



TBI 07-1901-30
30 cm/11 3/8"



For synthetic suture material
 one toothed cutting edge



TBI 07-1902-14
 14.5 cm/5 3/4"



TBI 07-1902-17
 17 cm/6 3/4"



TBI 07-1902-23
 23 cm/9"



- EN** Dressing & Tissue Forceps
- DE** Anatomische und Chirurgische Pinzetten
- ES** Pinzas de diseccion con dientes

Page 87 to 110

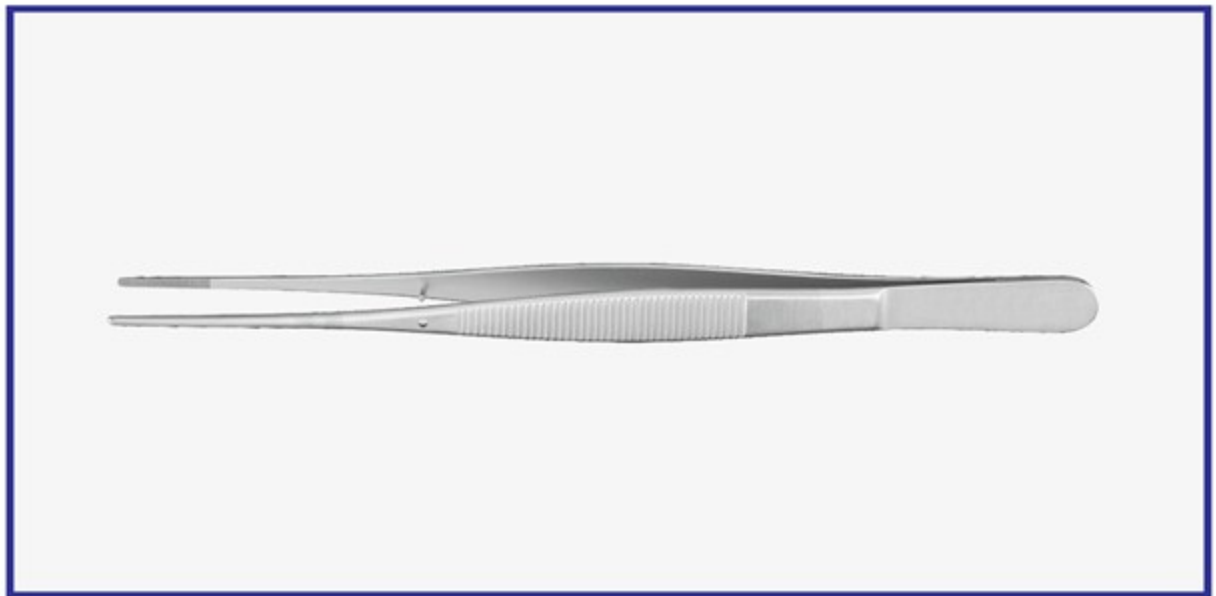



U.S.A. MODEL

- TBI 08-2001-12 12 cm/4 3/4"
- TBI 08-2001-13 13 cm/5 1/8"
- TBI 08-2001-14 14 cm/5 1/2"
- TBI 08-2001-15 15 cm/5 7/8"
- TBI 08-2001-18 18 cm/7 1/8"
- TBI 08-2001-21 21 cm/8 1/4"
- TBI 08-2001-23 23 cm/9"
- TBI 08-2001-25 25 cm/9 7/8"
- TBI 08-2001-31 31 cm/12 1/4"



GRACILE

- TBI 08-2002-12 12 cm/4 3/4"
- TBI 08-2002-13 13 cm/5 1/8"
- TBI 08-2002-14 14 cm/5 1/2"
- TBI 08-2002-15 15 cm/5 7/8"



ADSON

- TBI 08-2003-12 12 cm/4 3/4"
- TBI 08-2003-15 15 cm/5 7/8"



McINDOE

- TBI 08-2004-15 15 cm/5 7/8"
- TBI 08-2005-15 15.5 cm/6 1/8"



- TBI 08-2006-15 15 cm/5 7/8"
- TBI 08-2007-15 15.5 cm/6 1/8"
- 1 x 2



SEMKEN

- TBI 08-2008-12 12.5 cm/4 7/8"
- TBI 08-2008-15 15 cm/5 7/8"
- TBI 08-2008-18 18 cm/7 1/8"



SEMKEN

- TBI 08-2009-12 12.5 cm/4 7/8"
- TBI 08-2009-15 15 cm/5 7/8"
- TBI 08-2009-18 18 cm/7 1/8"



- TBI 08-2010-17



- TBI 08-2011-17



TAYLOR

- 17.5 cm/6 7/8"



STANDARD
(Narrow Pattern)

- TBI 08-2012-11 11.5 cm/4 1/2"
- TBI 08-2012-13 13 cm/5 1/8"
- TBI 08-2012-14 14 cm/5 1/2"
- TBI 08-2012-16 16 cm/6 1/4"
- TBI 08-2012-18 18 cm/7 1/8"
- TBI 08-2012-20 20 cm/7 7/8"
- TBI 08-2012-23 23 cm/9"
- TBI 08-2012-25 25 cm/9 7/8"
- TBI 08-2012-30 30 cm/11 3/4"



STANDARD
(Straight)

- TBI 08-2013-13 13 cm/5 1/8"
- TBI 08-2013-14 14 cm/5 1/2"
- TBI 08-2013-16 16 cm/6 1/4"



STANDARD
(Curved)

- TBI 08-2014-10 10.5 cm/4 1/8"
- TBI 08-2014-11 11.5 cm/4 1/2"
- TBI 08-2014-13 13 cm/5 1/8"
- TBI 08-2014-14 14 cm/5 1/2"
- TBI 08-2014-16 16 cm/6 1/4"
- TBI 08-2014-18 18 cm/7 1/8"
- TBI 08-2014-20 20 cm/7 7/8"
- TBI 08-2014-23 23 cm/9"
- TBI 08-2014-25 25 cm/9 7/8"
- TBI 08-2014-30 30 cm/11 3/4"

- TBI 08-2015-11 11.5 cm/4 1/2"
- TBI 08-2015-13 13 cm/5 1/8"
- TBI 08-2015-14 14 cm/5 1/2"
- TBI 08-2015-16 16 cm/6 1/4"
- TBI 08-2015-18 18 cm/7 1/8"
- TBI 08-2015-20 20 cm/7 7/8"
- TBI 08-2015-23 23 cm/9"

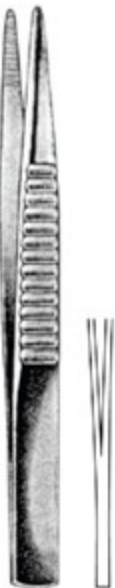

ENGL. MODELL

- TBI 08-2016-12 12.5 cm/4 7/8"
- TBI 08-2016-15 15.5 cm/6 1/8"



ENGL. MODELL

- TBI 08-2017-13 13 cm/5 1/8"
- TBI 08-2017-14 14.5 cm/5 3/4"



STANDARD

- TBI 08-2018-13 13 cm/5 1/8"
- TBI 08-2018-14 14 cm/5 1/2"



STILLE

- TBI 08-2019-15 15 cm/5 7/8"





1/4
TBI 08-2020-18
18 cm/7 1/8"
TBI 08-2020-21
21 cm/8 1/4"
TBI 08-2020-25
25 cm/9 7/8"

POTTS-SMITH



1/4
TBI 08-2021-18
18 cm/7 1/8"
TBI 08-2021-21
21 cm/8 1/4"
TBI 08-2021-25
25 cm/9 7/8"



BROPHY



1/4
TBI 08-2022-20
20 cm/7 7/8"



TBI 08-2023-20
20 cm/7 7/8"



GERALD
Serrated
TBI 08-2024-18 Str
TBI 08-2025-18 Cvd
18 cm/7 1/8"



with
dissector
TAYLOR
TBI 08-2026-17
17.5 cm/6 7/8"



TAYLOR
Dissector end
TBI 08-2027-17
17.5 cm/6 7/8"

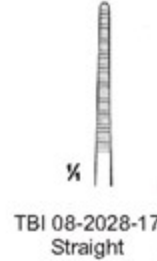

TBI 08-2028-17
Straight



TBI 08-2029-17
Curved



CUSHING
17.5 cm/6 7/8"

FORCEPS

Dissecting Forceps — EN
 Anatomische Pinzetten — DE
 Pinzas de disección — ES



WAUGH
 TBI 08-2030-15 15 cm/5 7/8"
 TBI 08-2030-20 20 cm/7 7/8"



WAUGH
 TBI 08-2031-15 15 cm/5 7/8"
 TBI 08-2031-20 20 cm/7 7/8"
 1 x 2 teeth



DUEHRSSSEN
 TBI 08-2032-20 20 cm/7 7/8"

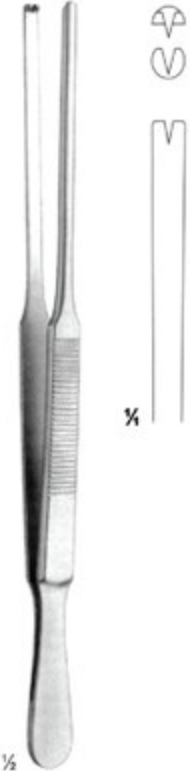

DUEHRSSSEN
 TBI 08-2033-20 20 cm/7 7/8"



LEEDS
 TBI 08-2034-15 15 cm/5 7/8"
 TBI 08-2034-17 17 cm/6 3/4"
 TBI 08-2034-20 20 cm/7 7/8"
 TBI 08-2034-25 25 cm/9 7/8"



LEEDS
 TBI 08-2035-15 15 cm/5 7/8"
 TBI 08-2035-17 17 cm/6 3/4"
 TBI 08-2035-20 20 cm/7 7/8"



RAMSEY
 TBI 08-2037-18 18 cm/7 1/8"
 1 x 2 Teeth

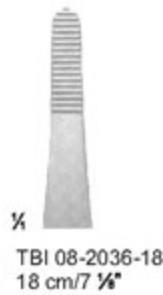

TBI 08-2036-18
 18 cm/7 1/8"



TBI 08-2038-18 18 cm/7 1/8"
 2 x 3 Teeth



MAINGOT
 TBI 08-2039-28 28 cm/11"





EVANS McINDOE
TBI 08-2040-15
15 cm/5 1/8"



FISCHL
TBI 08-2041-15
15 cm/5 1/8"



TBI 08-2042-25
25 cm/9 1/8"



TBI 08-2043-30
30 cm/11 1/8"



LLANDOUGH
TBI 08-2044-15
15 cm/5 1/8"



BARSKY
TBI 08-2045-15
15 cm/5 1/8"



BARSKY
TBI 08-2046-18
18 cm/7 1/8"



WANGENSTEEN
TBI 08-2047-23
23 cm/9"



DOTT
TBI 08-2048-18
18 cm/7 1/8"



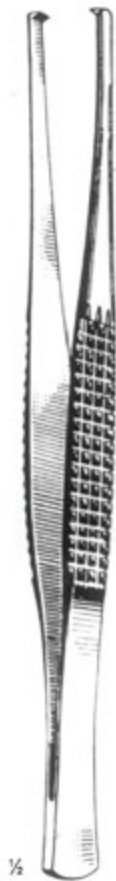

PYRAH
 3 x 4
 TBI 08-2049-23
 23 cm/9"



BROWN
 TBI 08-2050-15 15 cm/5 7/8"
 TBI 08-2050-20 20 cm/7 7/8"



MILES
 3 x 4
 TBI 08-2051-25
 25 cm/9 7/8"



MILLIN
 3 x 4
 TBI 08-2052-23
 23 cm/9"



THOMSON - WALKER
 1 x 2
 TBI 08-2053-19
 19 cm/7 1/2"



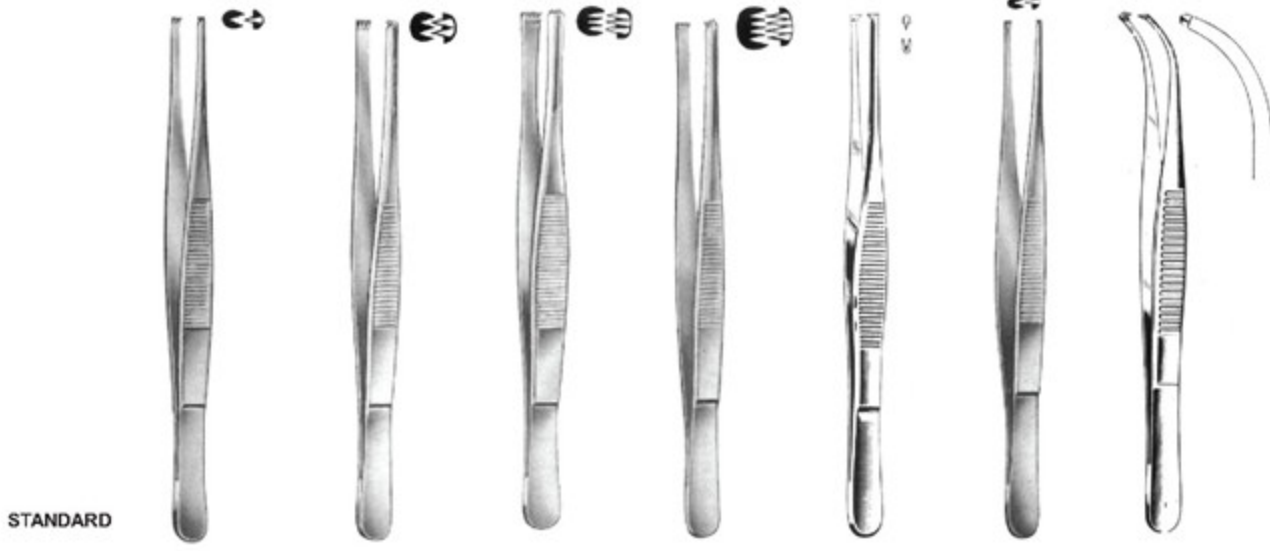

STANDARD

cm	in	1 : 2	2 : 3	3 : 4	4 : 5	1 : 2	1 : 2	1 : 2
10.5	4 1/8"	TBI 08-2054-10					narrow	curved
11.5	4 1/2"	TBI 08-2054-11	TBI 08-2055-11					TBI 08-2059-11
13.0	5 1/8"	TBI 08-2054-13	TBI 08-2055-13	TBI 08-2056-13	TBI 08-2057-13	TBI 08-2058-13		TBI 08-2059-13
14.5	5 3/4"	TBI 08-2054-14	TBI 08-2055-14	TBI 08-2056-14	TBI 08-2057-14	TBI 08-2058-14		TBI 08-2059-14
16.0	6 1/4"	TBI 08-2054-16	TBI 08-2055-16	TBI 08-2056-16	TBI 08-2057-16	TBI 08-2058-16		TBI 08-2059-16
18.0	7 1/8"	TBI 08-2054-18	TBI 08-2055-18			TBI 08-2058-18		TBI 08-2059-18
20.0	7 7/8"	TBI 08-2054-20	TBI 08-2055-20			TBI 08-2058-20		
23.0	9"	TBI 08-2054-23						
25.0	9 7/8"	TBI 08-2054-25	TBI 08-2055-25					
30.0	11 3/4"	TBI 08-2054-30	TBI 08-2055-30					

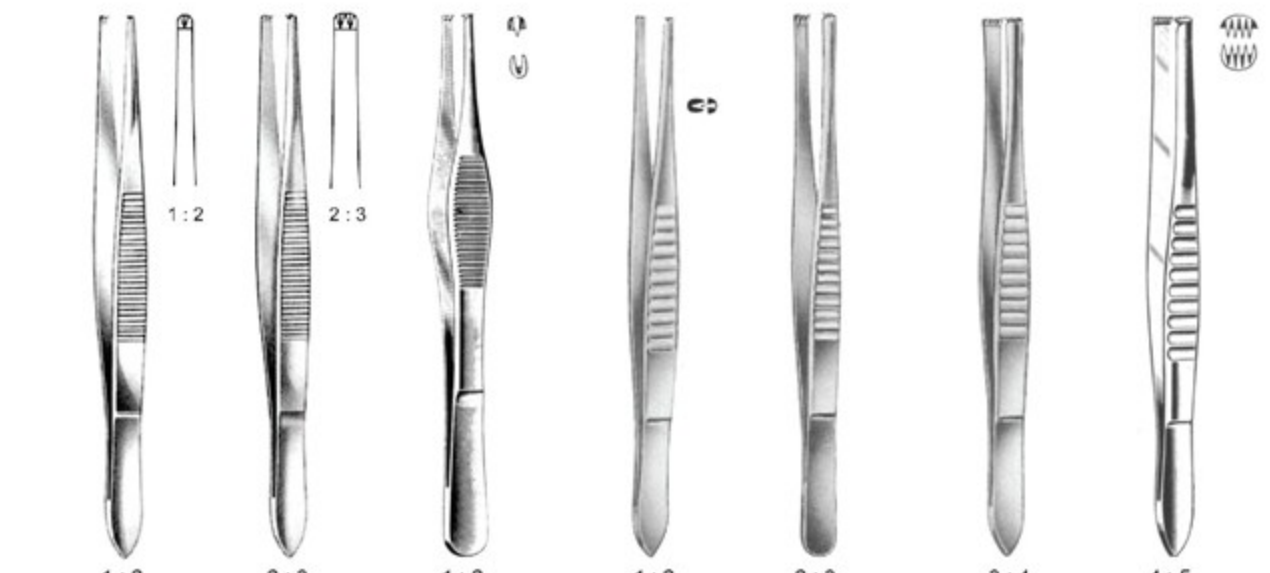

cm	in	1 : 2	2 : 3	1 : 2	1 : 2	2 : 3	3 : 4	4 : 5
		STILLE	STILLE		MOD. USA			
12.0	4 3/4"				TBI 08-2064-12	TBI 08-2065-12		
13.0	5 1/8"			TBI 08-2063-13	TBI 08-2064-13	TBI 08-2065-13	TBI 08-2066-13	TBI 08-2067-13
14.5	5 3/4"			TBI 08-2063-14	TBI 08-2064-14	TBI 08-2065-14	TBI 08-2066-14	TBI 08-2067-14
15.0	5 7/8"	TBI 08-2061-15	TBI 08-2062-15					
15.5	6 1/8"				TBI 08-2064-15	TBI 08-2065-15	TBI 08-2066-15	TBI 08-2067-15
18.5	7 1/4"				TBI 08-2064-18	TBI 08-2065-18		
21.0	8 1/4"				TBI 08-2064-21	TBI 08-2065-21		
25.0	9 7/8"				TBI 08-2064-25	TBI 08-2065-25		
31.0	12 1/4"				TBI 08-2064-31	TBI 08-2065-31		

FORCEPS

Tissue Forceps —
 Chirurgische Pinzetten —
 Pinzas de disección con diente —

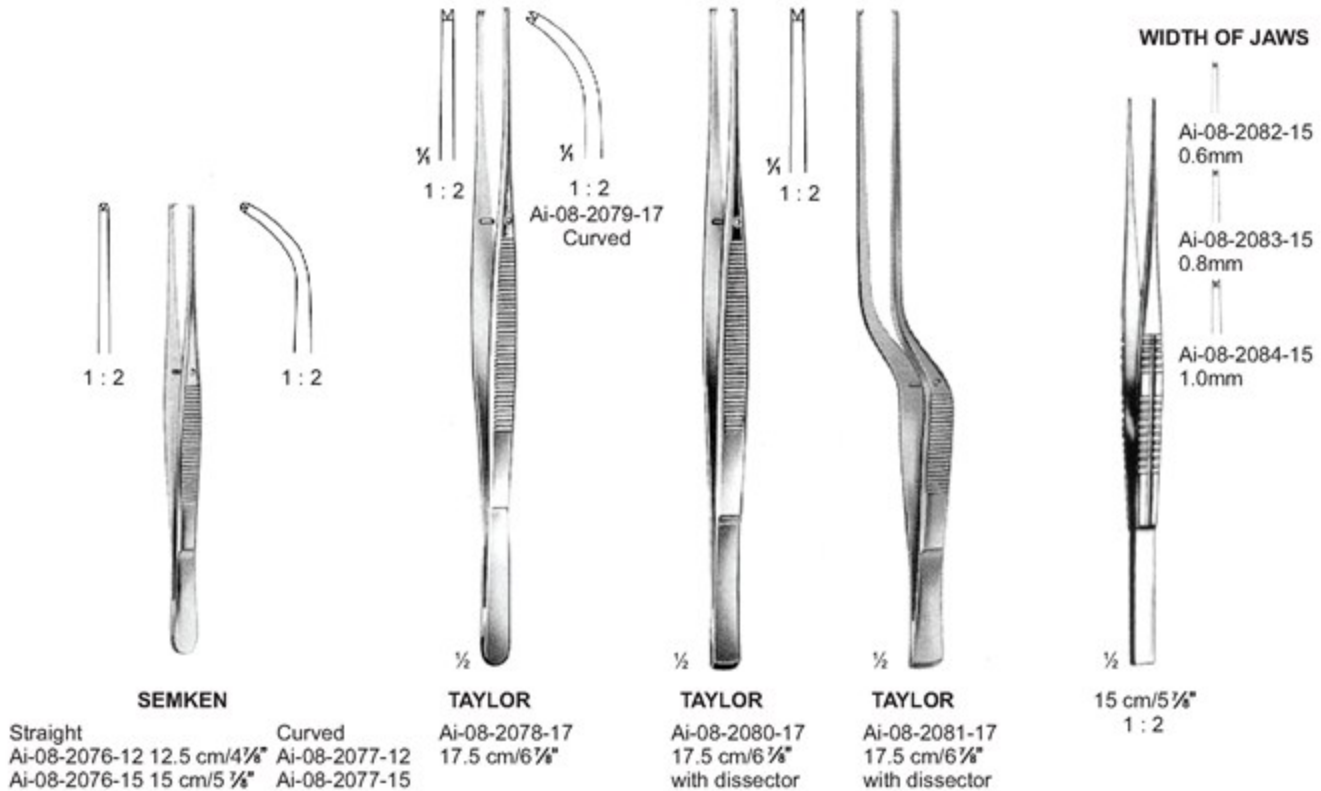
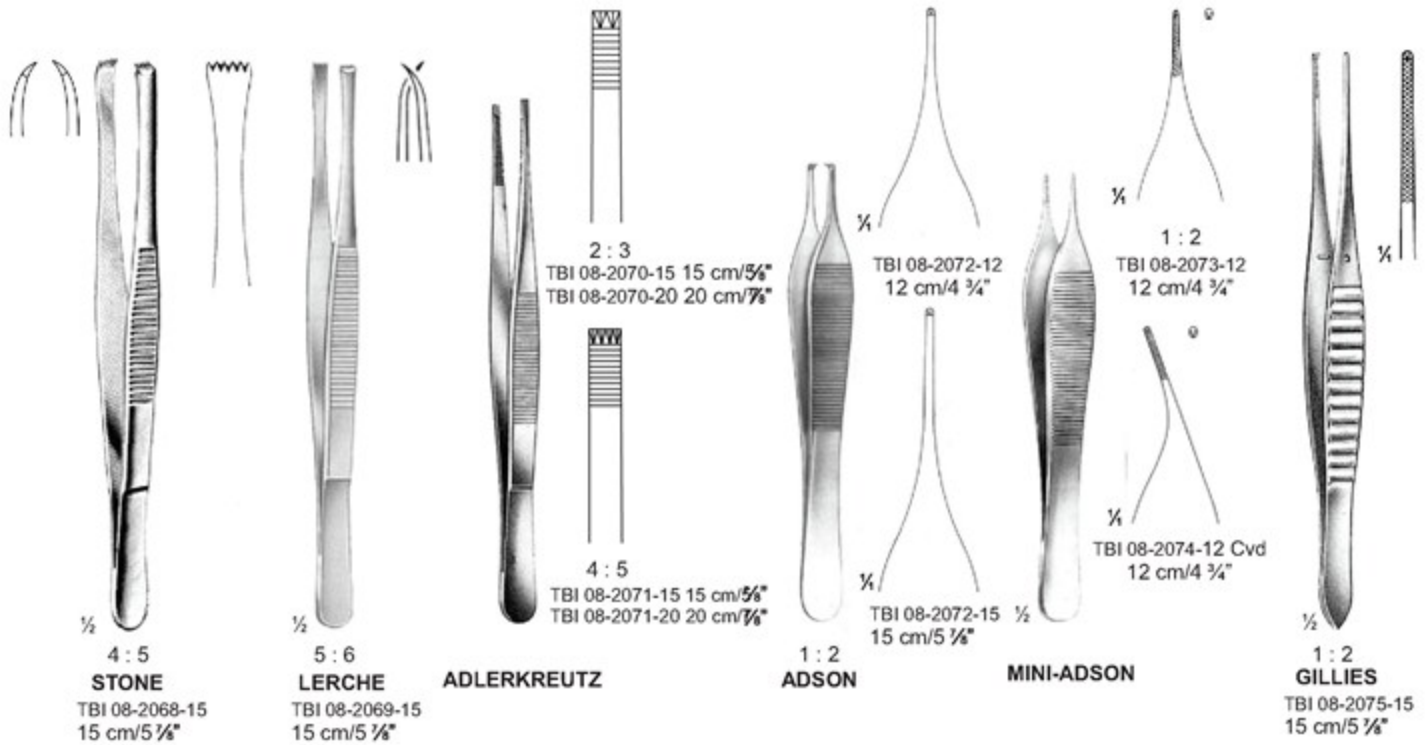



TBI 08-2086-17
Curved



GERALD
1 : 2
TBI 08-2085-17
17 cm/6 3/4"

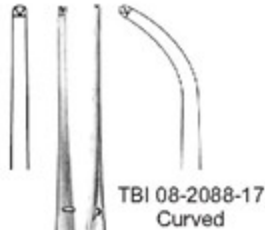

TBI 08-2088-17
Curved



CUSHING
1 : 2
TBI 08-2087-17
17 cm/6 3/4"



TBI 08-2090-18 18 cm/7 1/8"
 TBI 08-2090-21 21 cm/8 1/4"
 TBI 08-2090-25 25 cm/9 7/8"



POTTS-SMITH
TBI 08-2089-18 18 cm/7 1/8"
 TBI 08-2089-21 21 cm/8 1/4"
 TBI 08-2089-25 25 cm/9 7/8"

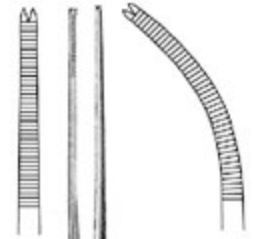

TBI 08-2092-20
20 cm/7 7/8"
Curved
1 x 2



BROPHY
1 x 2
TBI 08-2091-20
20 cm/7 7/8"



7 : 7

ADSON-BROWN
TBI 08-2093-12
12 cm/4 3/4"



MICRO-ADSON



TBI 08-2094-12
12 cm/4 3/4"



TBI 08-2095-15
15 cm/5 1/8"



MICRO-ADSON



TBI 08-2096-12
12 cm/4 3/4"



TBI 08-2097-15
15 cm/5 1/8"
1 : 2



Teeth extremely delicate

TBI 08-2098-11
11 cm/4 1/2"

FORCEPS

Tissue Forceps — EN
 Chirurgische Pinzetten — DE
 Pinzas de disección con diente — ES



TREVES
 TBI 08-2099-13 13 cm/5 1/8"
 TBI 08-2099-15 15 cm/5 7/8"

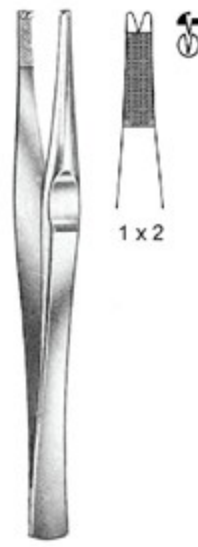

LANE
 TBI 08-2100-14 14 cm/5 1/2"
 TBI 08-2100-20 20 cm/7 7/8"

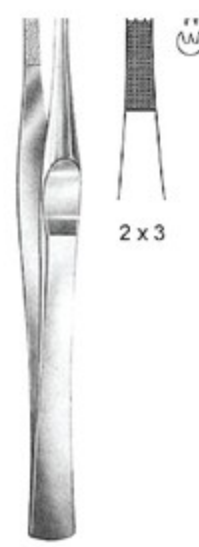

LANE
 TBI 08-2101-14 14 cm/5 1/2"
 TBI 08-2101-20 20 cm/7 7/8"

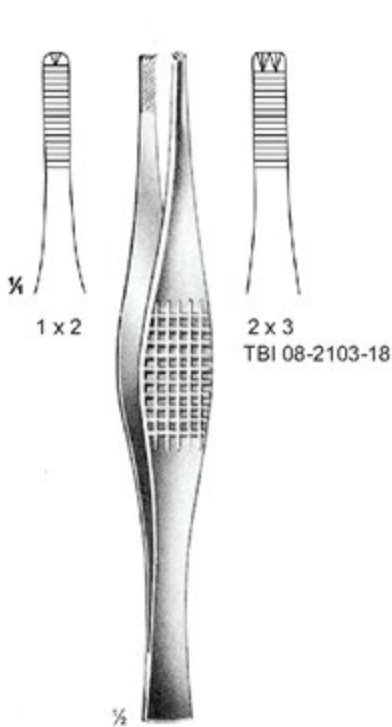

FERRIS-SMITH
 TBI 08-2102-18
 18 cm/7 1/8"

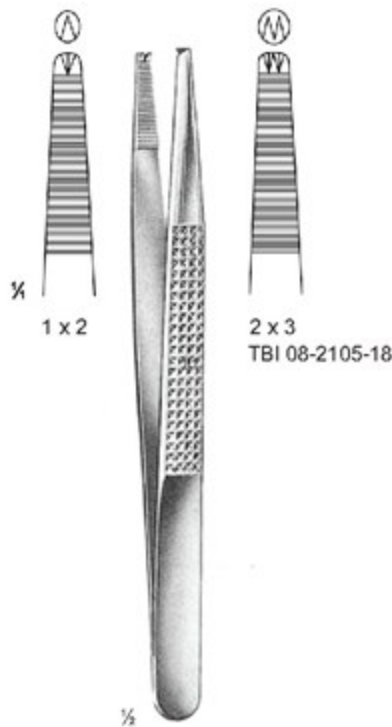

BONNEY
 TBI 08-2104-18
 18 cm/7 1/8"

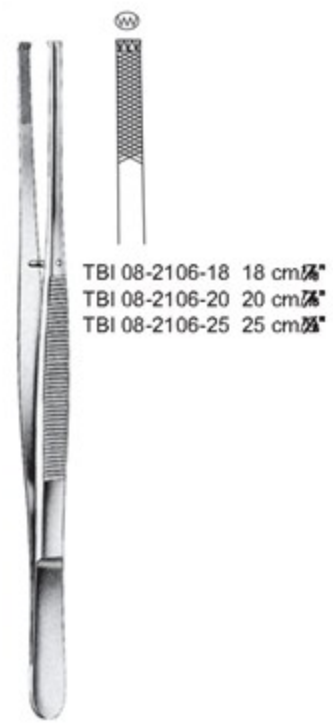

STILLE-BARRAYA

TBI 08-2106-18 18 cm/7 1/8"
 TBI 08-2106-20 20 cm/7 7/8"
 TBI 08-2106-25 25 cm/9 7/8"



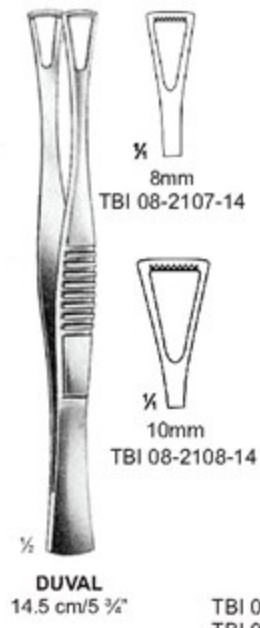

RUSS. MODELL

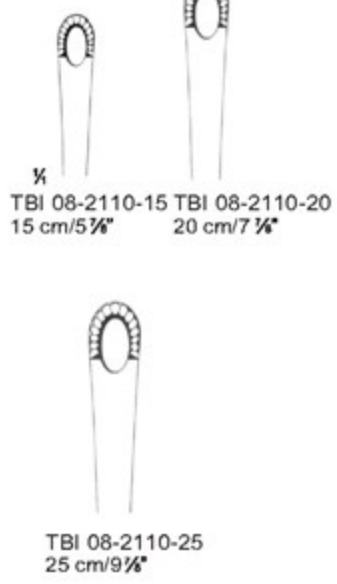

COLLIN-DUVAL
20 cm/7 7/8"

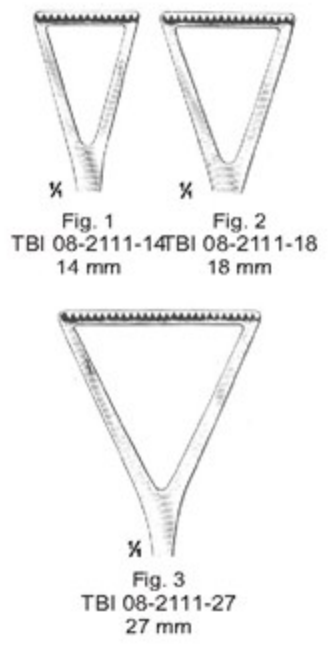

NELSON
TBI 08-2112-15
15 cm/5 7/8"
TBI 08-2112-23
23 cm/9"



DAVIS
TBI 08-2113-25
25 cm/9 7/8"



MAYO-RUSS
TBI 08-2114-23
23 cm/9"



SINGLEY-TUTTLE
TBI 08-2115-23
23 cm/9"



LEEDS

1 x 2

TBI 08-2116-15 15 cm/5 7/8"
 TBI 08-2116-17 17 cm/6 3/4"
 TBI 08-2116-20 20 cm/7 7/8"



LEEDS

2 x 3

TBI 08-2117-15
 15 cm/5 7/8"



JEAN

1 x 2

TBI 08-2118-14 14 cm/5 1/2"
 TBI 08-2118-18 18 cm/7 1/8"



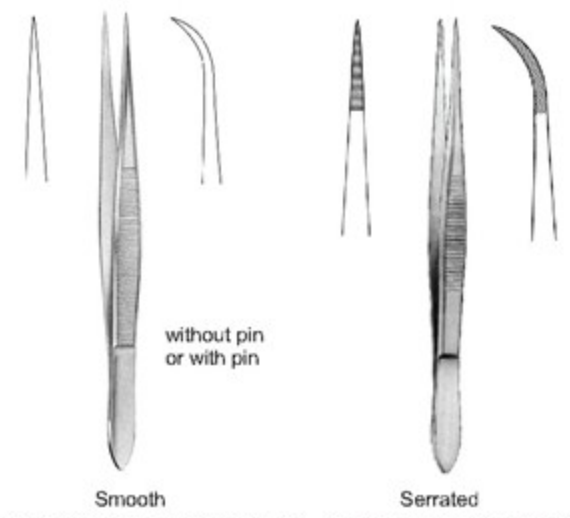
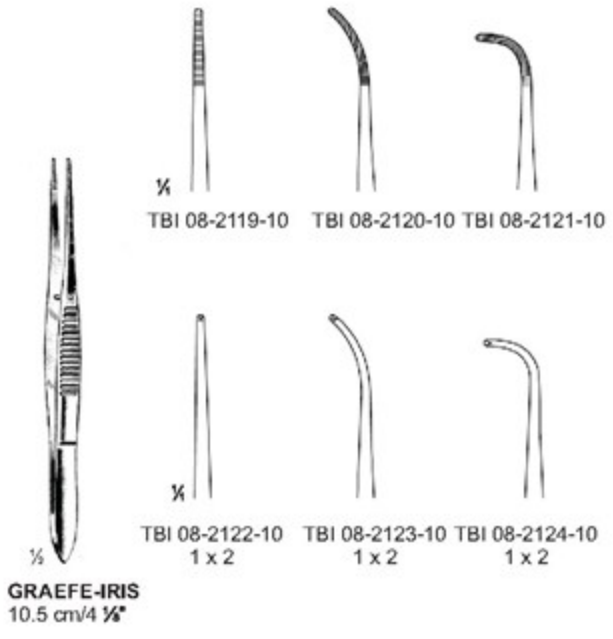

8 cm/3 1/4"	TBI 08-2125-08	TBI 08-2126-08	TBI 08-2127-08	TBI 08-2128-08
9 cm/3 1/2"	TBI 08-2125-09	TBI 08-2126-09	TBI 08-2127-09	TBI 08-2128-09
10.5 cm/4 1/8"	TBI 08-2125-10	TBI 08-2126-10	TBI 08-2127-10	TBI 08-2128-10
11.5 cm/4 1/2"	TBI 08-2125-11	TBI 08-2126-11	TBI 08-2127-11	TBI 08-2128-11
12.5 cm/4 3/8"	TBI 08-2125-12	TBI 08-2126-12	TBI 08-2127-12	TBI 08-2128-12

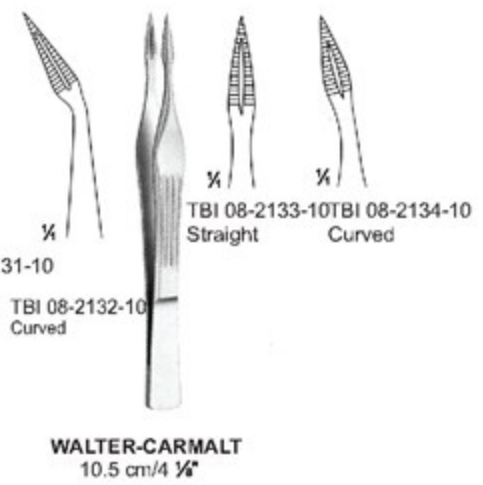
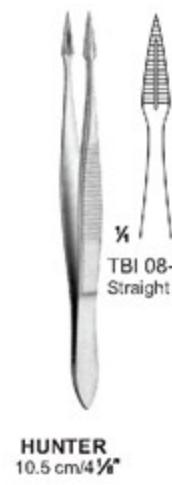
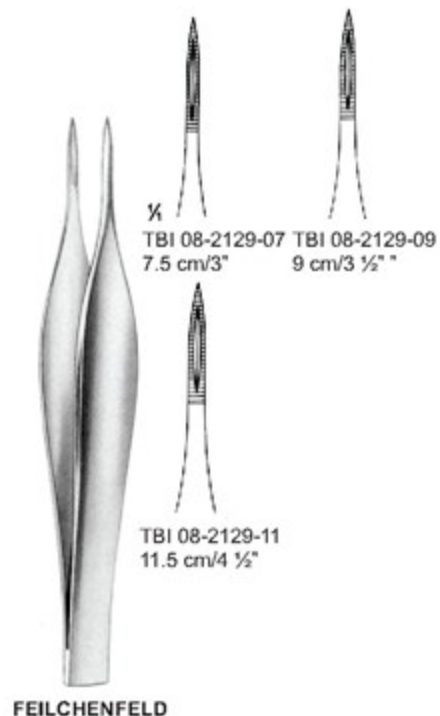

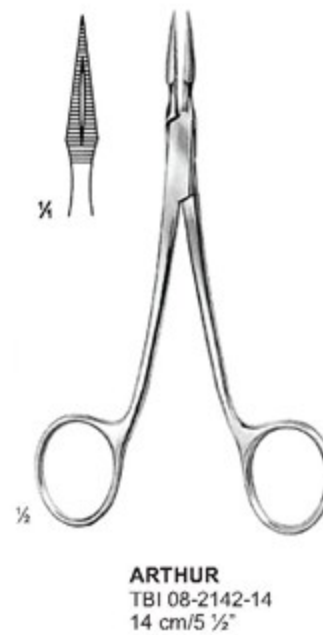
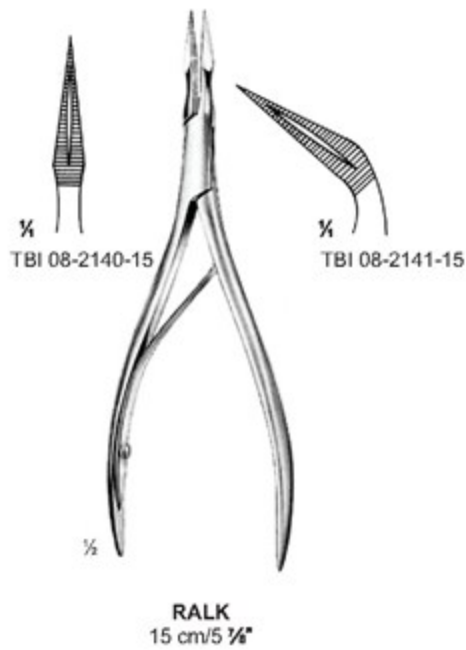
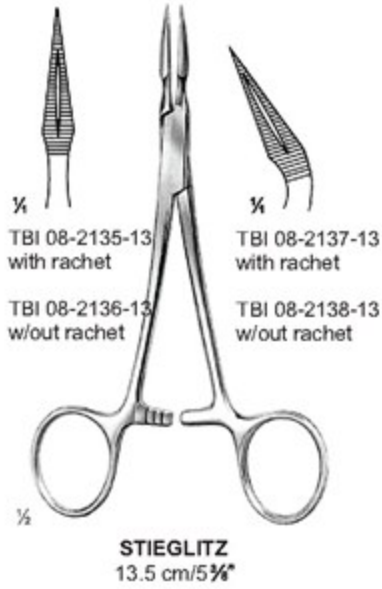

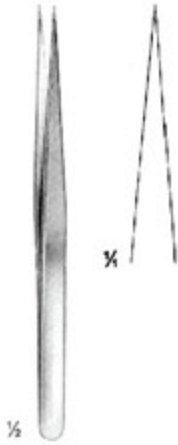

TBI 08-2143-11
No. 3
11.5 cm/4 1/2"

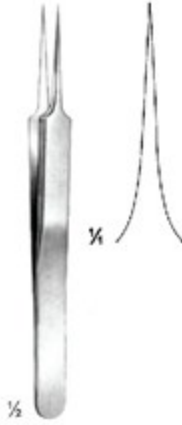

TBI 08-2144-11
No. 4
11 cm/4 1/2"

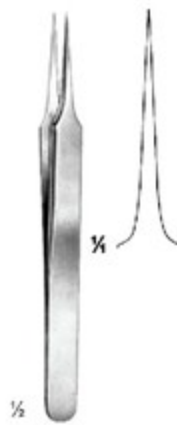

TBI 08-2145-11
No. 5
11 cm/4 1/2"

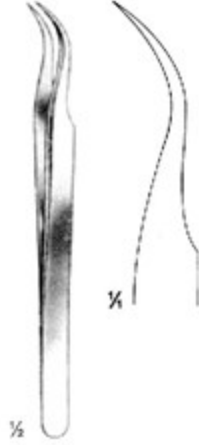

TBI 08-2146-11
No. 7
11.5 cm/4 1/2"



TBI 08-2147-10
10.5 cm/4 1/4"



TBI 08-2148-10
10.5 cm/4 1/4"



TBI 08-2149-11
11.5 cm/4 1/2"



TBI 08-2150-11
11.5 cm/4 1/2"

FORCEPS

Bulldog Clamps ● EN
 Bulldogklemmen ● DE
 Clamps bulldog ● ES



DIEFFENBACH

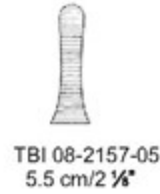
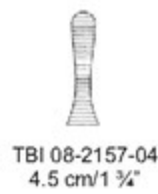
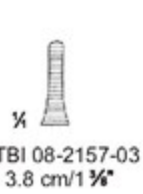
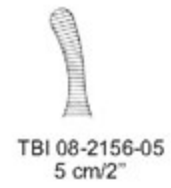
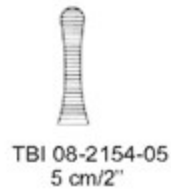
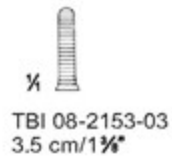
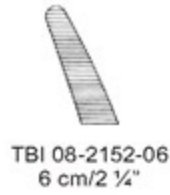
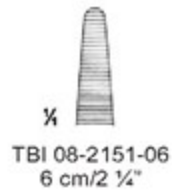

DIEFFENBACH

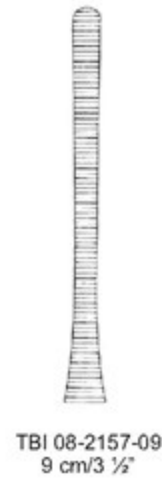
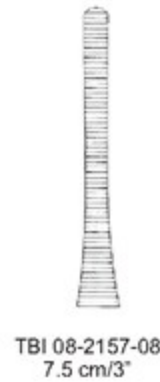
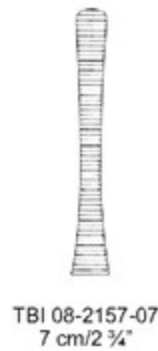
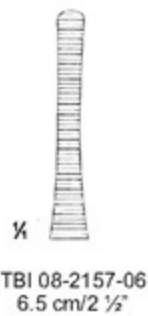

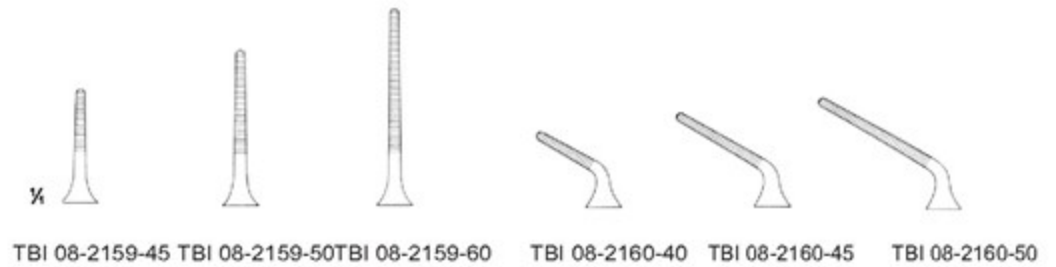
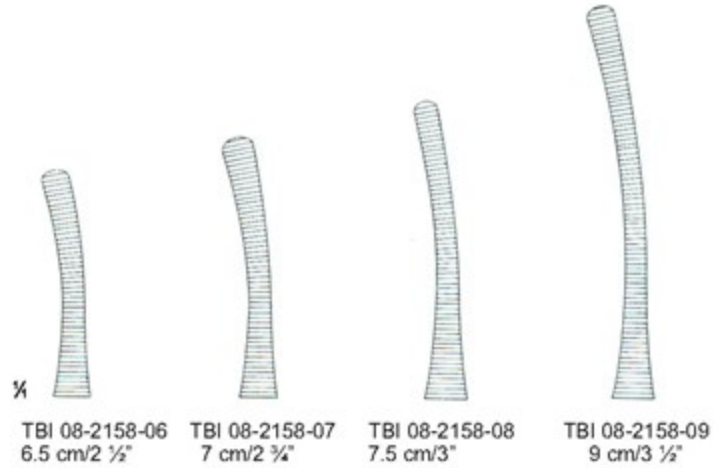

Length	45 mm	50 mm	60 mm	40 mm	45 mm	50 mm
Jaw Length	8 mm	12 mm	20 mm	8 mm	12 mm	20 mm
Closing Pressure	50 gr	50 gr	50 gr	50 gr	50 gr	50 gr
Weight	3 gr	3 gr	3 gr	3 gr	3 gr	3 gr

ATRAUMA



TBI 08-2161-45 TBI 08-2161-50 TBI 08-2161-60 TBI 08-2162-35 TBI 08-2162-45 TBI 08-2162-50

Length	45 mm	50 mm	60 mm	35 mm	45 mm	50 mm
Jaw Length	10 mm	14 mm	20 mm	10 mm	14 mm	20 mm
Closing Pressure	180 gr	180 gr	180 gr	180 gr	180 gr	180 gr
Weight	3 gr	3 gr	3 gr	3 gr	3 gr	3 gr

DE BAKEY-DIETRICH



JOHNS-HOPKINS
 TBI 08-2163-05 5 cm/2"
 TBI 08-2163-06 6.5 cm/2 1/2"
 TBI 08-2163-07 7.5 cm/3"

JOHNS-HOPKINS
 TBI 08-2164-05 5 cm/2"
 TBI 08-2164-06 6.5 cm/2 1/2"
 TBI 08-2164-07 7.5 cm/3"

HESS L
 TBI 08-2165-20 20 mm
 TBI 08-2165-30 30 mm



ATRAUMA



TBI 08-2166-07
7 cm/2 3/4"

DEBAKEY-SATINSKY



TBI 08-2167-09
9 cm/3 1/2"

DEBAKEY-SATINSKY



TBI 08-2168-10
10 cm/3 1/4"

DEBAKEY-SATINSKY



TBI 08-2169-06
6 cm/2 1/4"

GLOVER



TBI 08-2170-07
7 cm/2 3/4"

SANTULLI



ATRAUMA



GREGORY SOFT
 Carotid Clamp



TBI 08-2171-09
 9 cm/3 1/2"



TBI 08-2171-11
 11 cm/4 3/8"



GREGORY
 Carotid Clamp



TBI 08-2172-10
 10.5 cm/4 1/8"
 Right



TBI 08-2173-10
 10.5 cm/4 1/8"
 Left





ATRAUMA



DEBAKEY



TBI 08-2174-07
7.5 cm/3"



TBI 08-2174-08
8.5 cm/3 3/8"



TBI 08-2174-10
10 cm/3 1/2"



TBI 08-2174-12
12 cm/4 3/8"



DEBAKEY



TBI 08-2175-07
7.5 cm/3"



TBI 08-2175-08
8.5 cm/3 3/8"



TBI 08-2175-09
9.5 cm/3 3/4"



TBI 08-2175-11
11 cm/4 3/8"

ATRAUMA



GLOVER



TBI 08-2176-07
 7 cm/2 3/4"



TBI 08-2176-08
 7.5 cm/3"



TBI 08-2176-09
 9 cm/3 1/2"



TBI 08-2176-11
 11 cm/4 1/4"



GLOVER



TBI 08-2177-06
 6.5 cm/2 1/2"



TBI 08-2177-07
 7 cm/2 3/4"



TBI 08-2177-08
 8.5 cm/3 3/4"



TBI 08-2177-10
 10.5 cm/4 1/4"



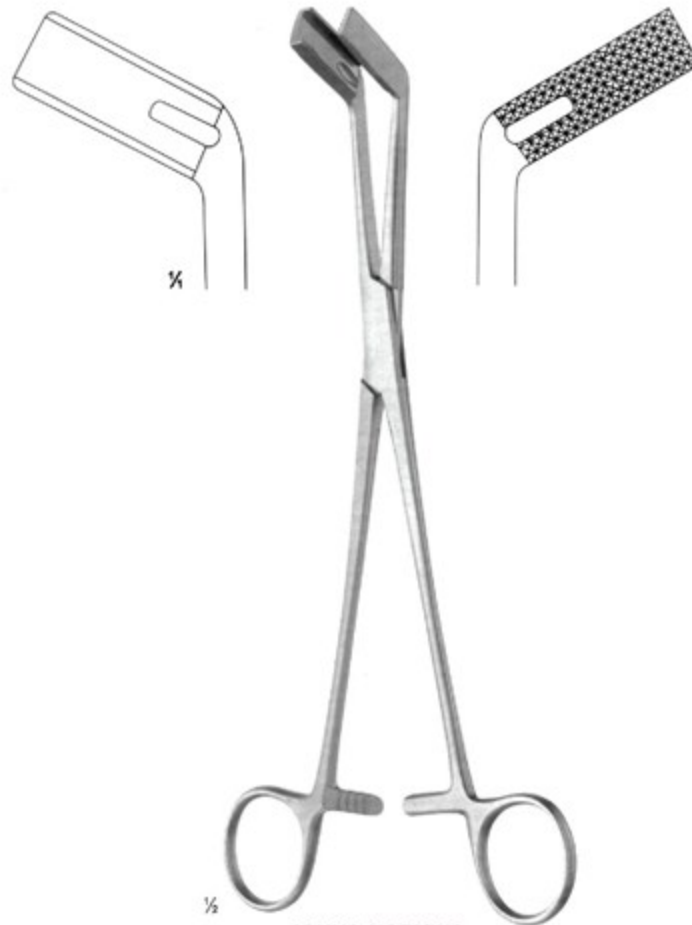

JOHNS-HOPKINS
TBI 08-2178-24
24.5 cm/9 7/8"

Applying forceps for Johns-Hopkins
and DeBakey Bulldog clamps

FORCEPS

ATRAUMA

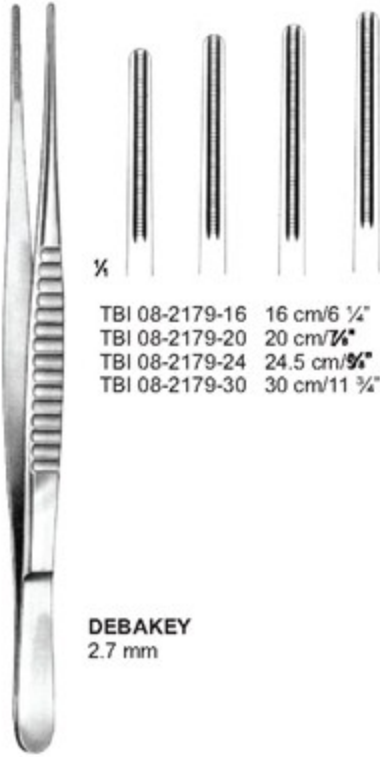

- ¼
- TBI 08-2179-16 16 cm/6 ¼"
 - TBI 08-2179-20 20 cm/7 ¾"
 - TBI 08-2179-24 24.5 cm/9 ¾"
 - TBI 08-2179-30 30 cm/11 ¾"

DEBAKEY
2.7 mm

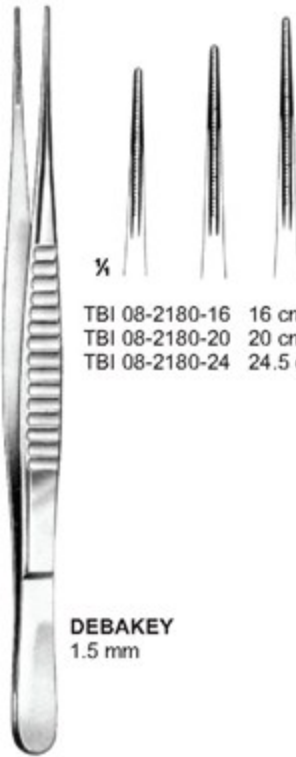

- ¼
- TBI 08-2180-16 16 cm/6 ¼"
 - TBI 08-2180-20 20 cm/7 ¾"
 - TBI 08-2180-24 24.5 cm/9 ¾"

DEBAKEY
1.5 mm

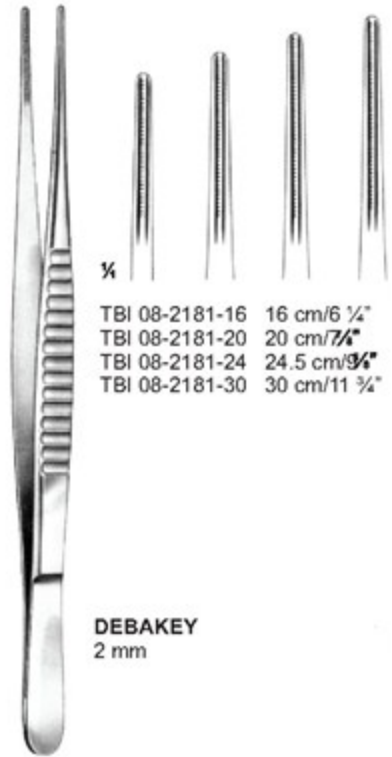

- ¼
- TBI 08-2181-16 16 cm/6 ¼"
 - TBI 08-2181-20 20 cm/7 ¾"
 - TBI 08-2181-24 24.5 cm/9 ¾"
 - TBI 08-2181-30 30 cm/11 ¾"

DEBAKEY
2 mm

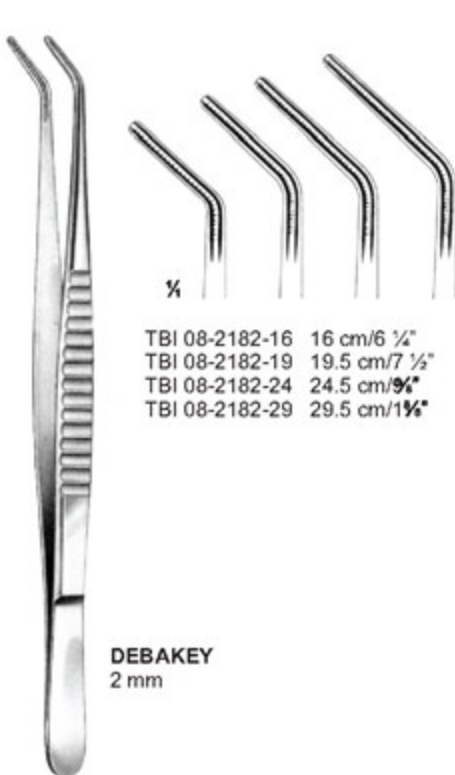

- ¼
- TBI 08-2182-16 16 cm/6 ¼"
 - TBI 08-2182-19 19.5 cm/7 ½"
 - TBI 08-2182-24 24.5 cm/9 ¾"
 - TBI 08-2182-29 29.5 cm/11 ¾"

DEBAKEY
2 mm

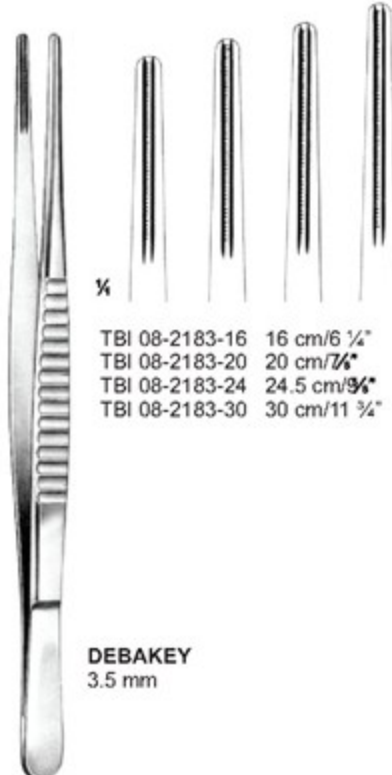

- ¼
- TBI 08-2183-16 16 cm/6 ¼"
 - TBI 08-2183-20 20 cm/7 ¾"
 - TBI 08-2183-24 24.5 cm/9 ¾"
 - TBI 08-2183-30 30 cm/11 ¾"

DEBAKEY
3.5 mm

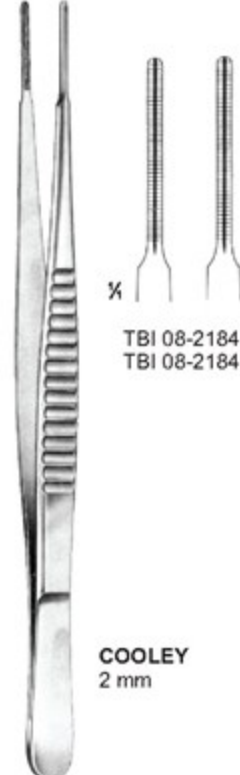

- ¼
- TBI 08-2184-16 16 cm/6 ¼"
 - TBI 08-2184-20 20 cm/7 ¾"

COOLEY
2 mm



EN TC Forceps

DE TC-Zange

ES Pinzas TC

Page 111 to 114

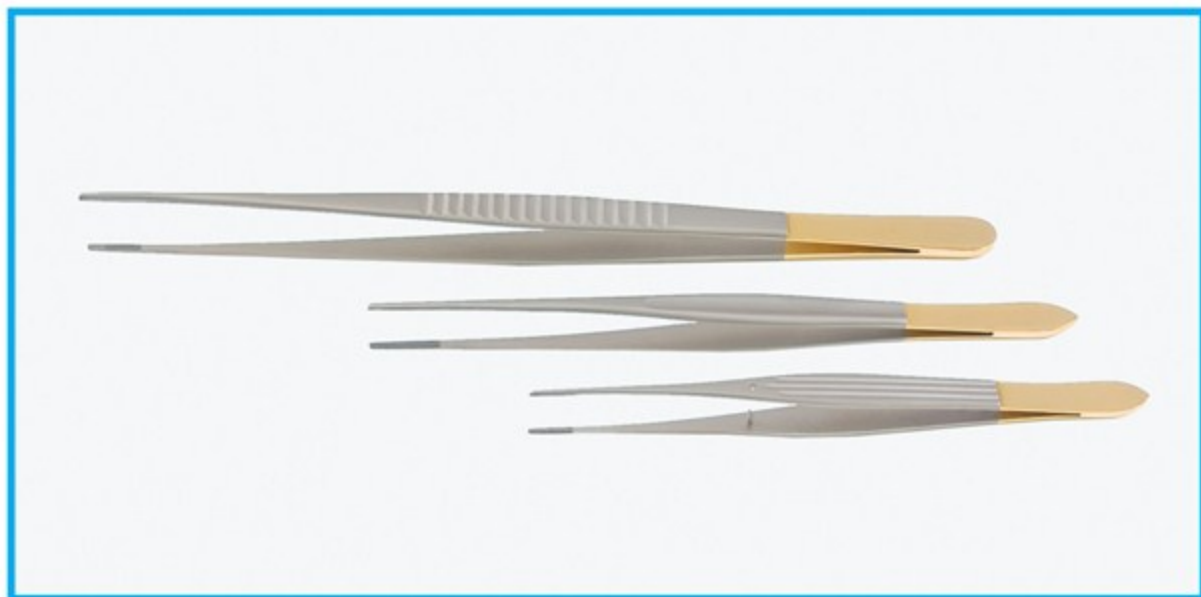



ADSON

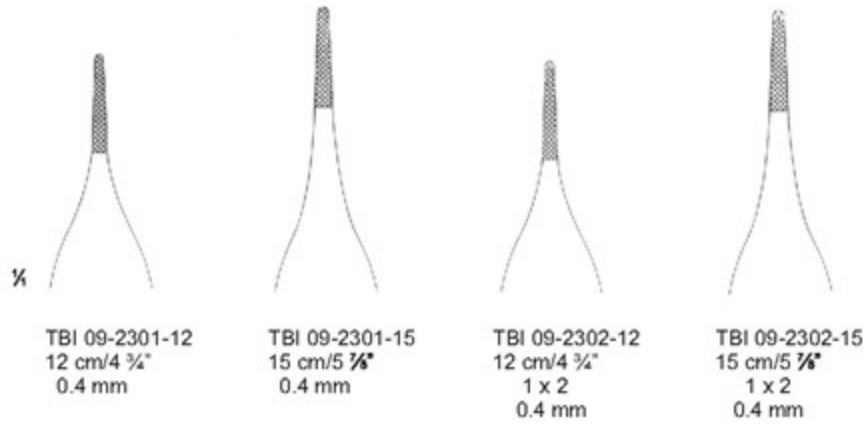

MICRO ADSON



ADSON BROWN
TBI 09-2305-12
12 cm/4 3/4"



TC FORCEPS

Vascular Forceps — EN
 Gefäßpinzetten — DE
 Pinzas de disección vascular — ES



09



STANDARD
 TBI 09-2306-14 14.5 cm/5 3/4"
 TBI 09-2306-16 16 cm/6 1/4"
 TBI 09-2306-18 18 cm/7 1/8"
 TBI 09-2306-20 20 cm/7 7/8"
 TBI 09-2306-25 25 cm/9 7/8"
 TBI 09-2306-30 30 cm/11 3/4"



OEHLER

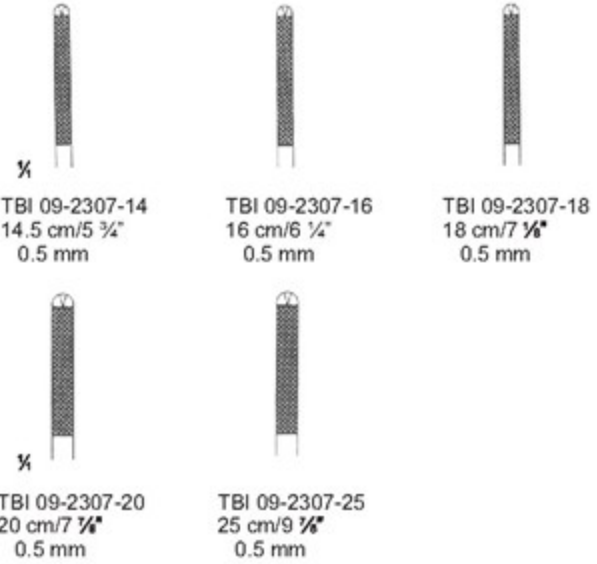

USA MOD.
 15 cm/5 7/8"

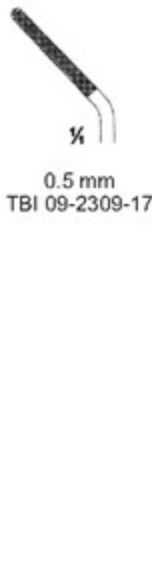

CUSHING
 17.5 cm/6 7/8"

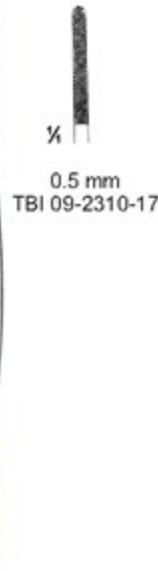

CUSHING-TAYLOR
 18 cm/7 1/8"





POTTS-SMITH



TBI 09-2312-16
16 cm/6 1/4"
0.5 mm



TBI 09-2312-18
18 cm/7 1/4"
0.5 mm



TBI 09-2312-20
20 cm/7 7/8"
0.5 mm



TBI 09-2312-23
23 cm/9"
0.5 mm



TBI 09-2312-25
25 cm/9 7/8"
0.5 mm



WANGENSTEEN



TBI 09-2313-15
15 cm/5 7/8"
0.5 mm



TBI 09-2313-23
23 cm/9"
0.5 mm

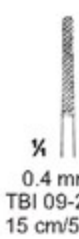

0.4 mm
TBI 09-2314-15
15 cm/5 7/8"



0.4 mm
TBI 09-2315-15
15 cm/5 7/8"



SEMKEN



0.4 mm
TBI 09-2316-15
15 cm/5 7/8"



MCINDOE



0.5 mm
TBI 09-2317-18
18 cm/7 1/8"



0.5 mm
TBI 09-2318-18
18 cm/7 1/8"



BONNEY



GILLIES
 TBI 09-2319-15
 15 cm/5 7/8"

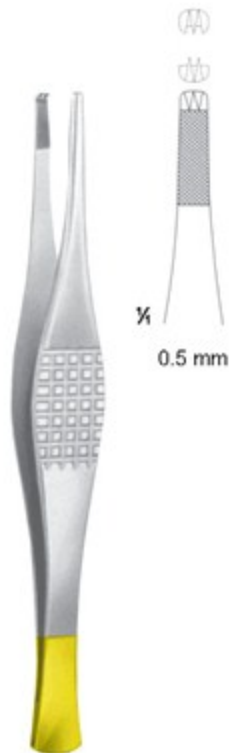

FERRIS-SMITH
 TBI 09-2320-18
 18 cm/7 1/8"



DEBAKEY-ATRAUMA
 TBI 09-2321-15 15 cm/5 7/8"
 TBI 09-2321-19 19 cm/7 1/2"
 TBI 09-2321-24 24 cm/9 1/2"



EN Titanium Forceps

DE Titan-Pinzetten

ES Pinzas de titanio

Page 115 to 116

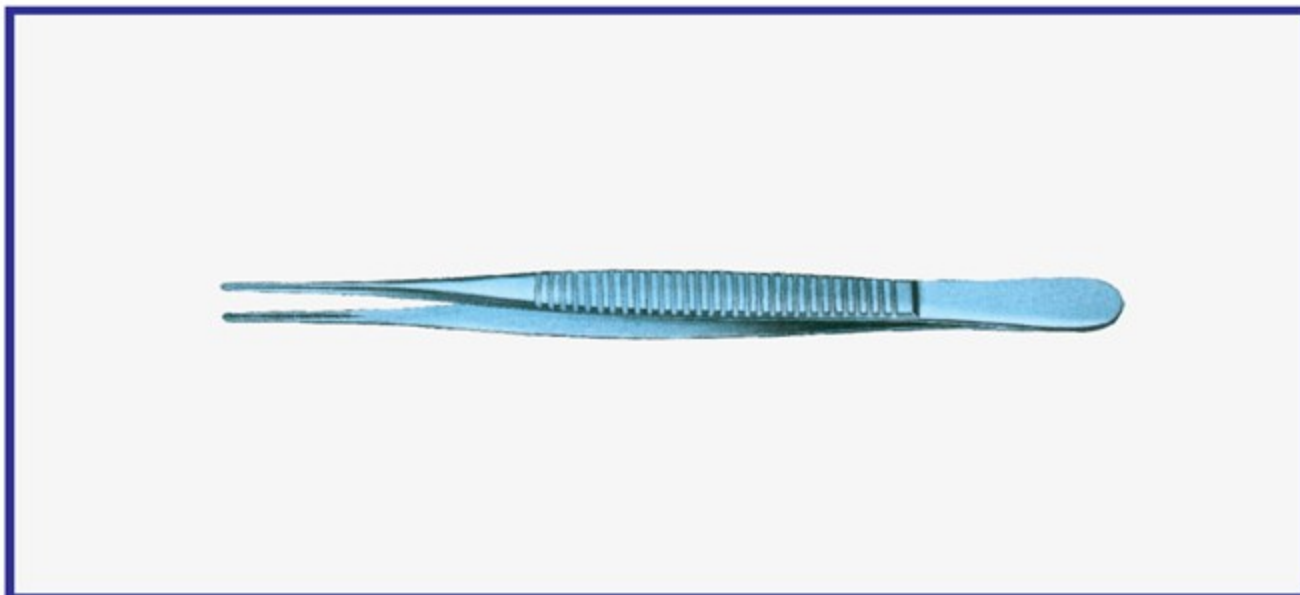

ATRAUMA



TITANIUM



TBI 10-2401-00
Vena
Closing pressure
110 +/- 10 gr



TBI 10-2402-00
Vena
Closing pressure
110 +/- 10 gr



TBI 10-2403-00
Vena
Closing pressure
110 +/- 10 gr



TBI 10-2404-00
Vena
Closing pressure
110 +/- 10 gr

	Arteria	Arteria	Arteria	Arteria
Closing Pressure	220 +/- 10 gr	220 +/- 10 gr	220 +/- 10 gr	220 +/- 10 gr
Length	30 mm	35 mm	40 mm	50 mm
Jaw Length	9 mm	13 mm	14 mm	23 mm
Weight	1 gr	1 gr	1 gr	1.5 gr



TBI 10-2405-00
Vena
Closing pressure
110 +/- 10 gr



TBI 10-2406-00
Vena
Closing pressure
110 +/- 10 gr



TBI 10-2407-00
Vena
Closing pressure
110 +/- 10 gr



TBI 10-2408-00
Vena
Closing pressure
110 +/- 10 gr

	Arteria	Arteria	Arteria	Arteria
Closing Pressure	220 +/- 10 gr	220 +/- 10 gr	220 +/- 10 gr	220 +/- 10 gr
Length	30 mm	35 mm	40 mm	50 mm
Jaw Length	9 mm	13 mm	14 mm	23 mm
Weight	1 gr	1 gr	1 gr	1.5 gr



TBI 10-2409-00
Vena
Closing pressure
110 +/- 10 gr



TBI 10-2410-00
Vena
Closing pressure
110 +/- 10 gr



TBI 10-2411-00
Vena
Closing pressure
110 +/- 10 gr



TBI 10-2412-00
Vena
Closing pressure
110 +/- 10 gr

	Arteria	Arteria	Arteria	Arteria
Closing Pressure	220 +/- 10 gr	220 +/- 10 gr	220 +/- 10 gr	220 +/- 10 gr
Length	30 mm	35 mm	40 mm	50 mm
Jaw Length	9 mm	13 mm	14 mm	23 mm
Weight	1 gr	1 gr	1 gr	1.5 gr



ATRAUMA



DEBAKEY



TBI 10-2413-16
 16 cm/6 1/4"
 1.5 mm



TBI 10-2413-20
 20.5 cm/8 1/8"
 1.5 mm



TBI 10-2413-24
 24.5 cm/9 3/4"
 1.5 mm



TBI 10-2414-16
 16 cm/6 1/4"
 1.8 mm



TBI 10-2414-20
 20.5 cm/8 1/8"
 1.8 mm



TBI 10-2414-24
 24.5 cm/9 3/4"
 1.8 mm



- EN** Artery Forceps
- DE** Arterienklemmen
- ES** Pinzas hemostáticas

Page 117 to 157



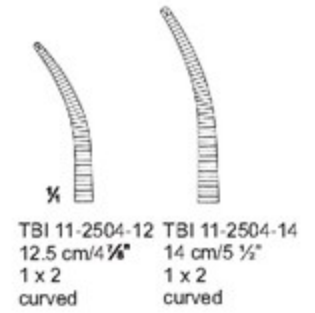
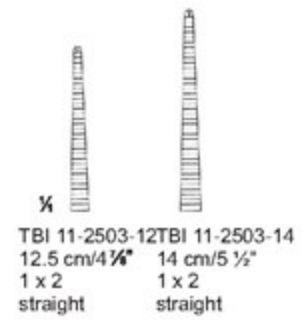
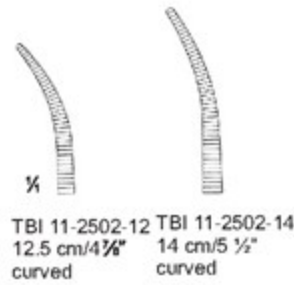
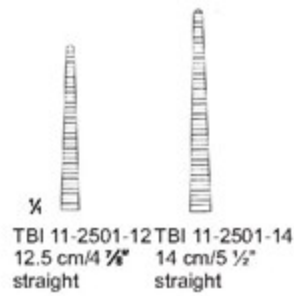

ATRAUMA

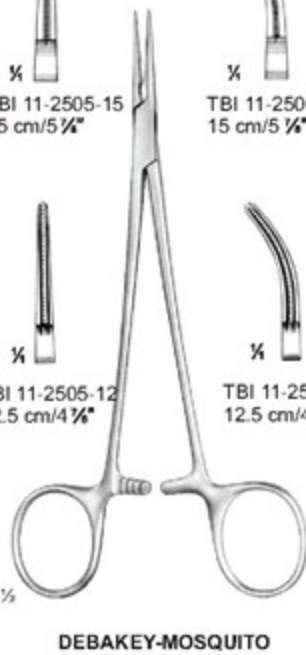
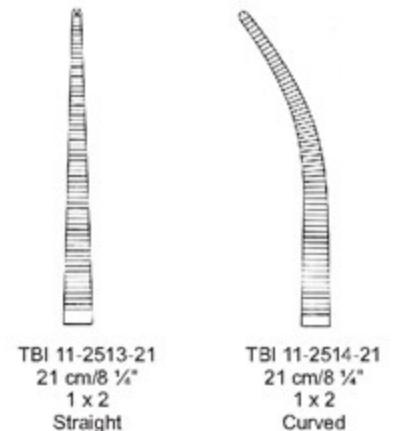
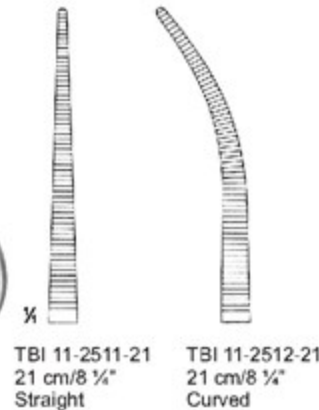
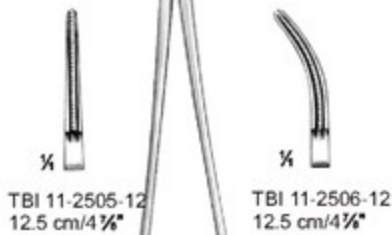
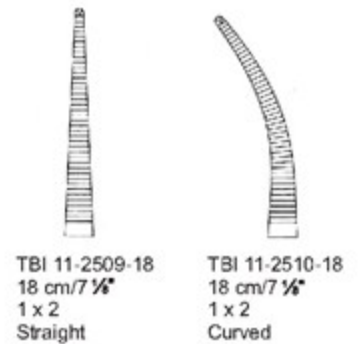
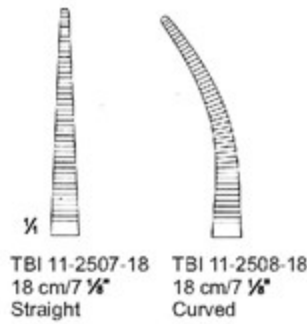
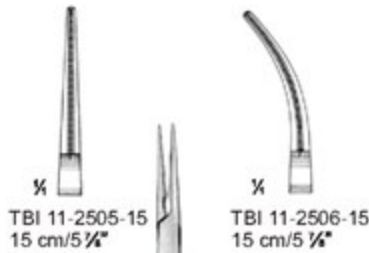

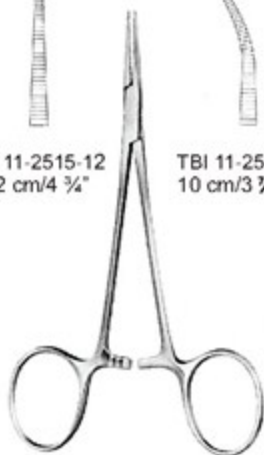
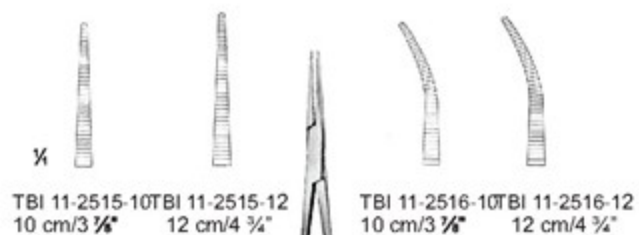

MICRO-MOSQUITO

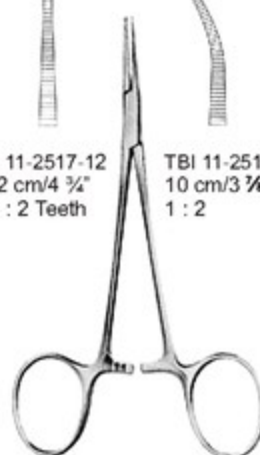
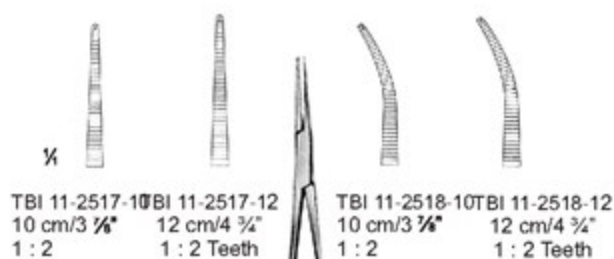

MICRO-MOSQUITO

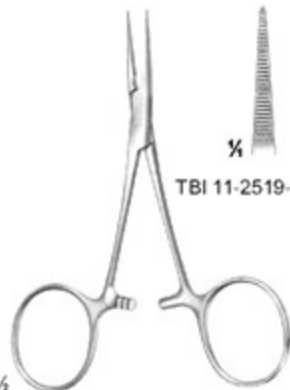

**HARTMANN
 (BABY-MOSQUITO)**
 10 cm/3 ¾"



CARREL
 TBI 11-2523-08
 8.5 cm/3 ¾"

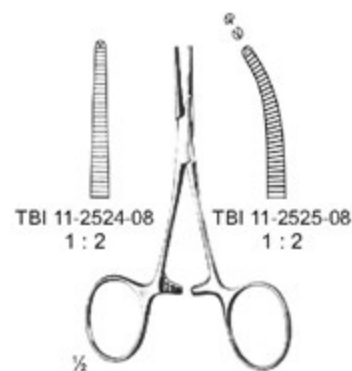

TERRIER
 8.5 cm/3 ¾"



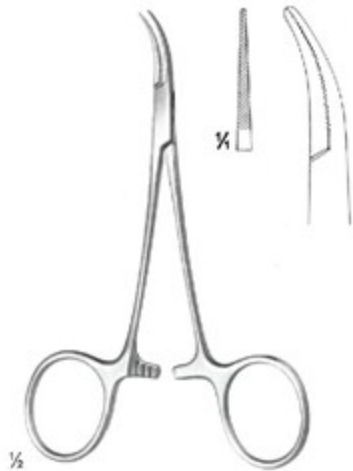

MOSQUITO-DANDY
TBI 11-2526-12
12 cm/4 3/4"



DANDY
14 cm/5 1/2"

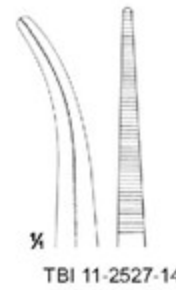

TBI 11-2527-14

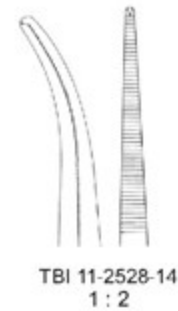

TBI 11-2528-14
1 : 2

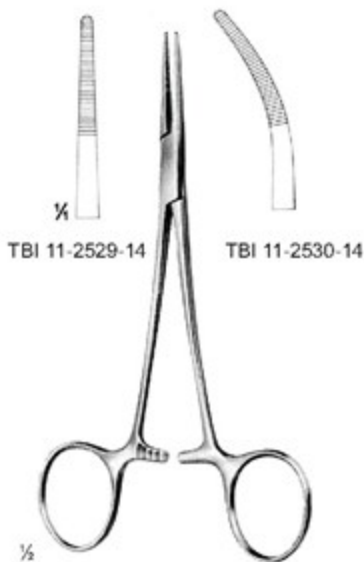

PROVIDENCE-HOSPITAL
14 cm/5 1/2"

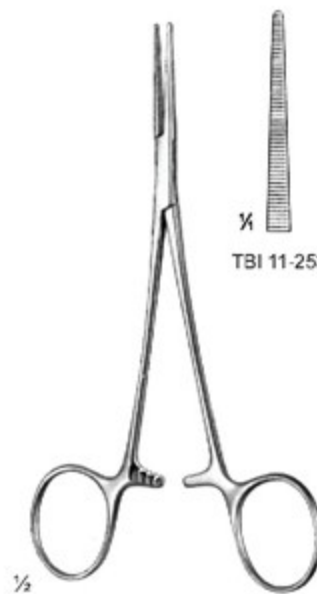

LERICHE
15 cm/5 7/8"

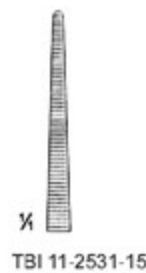

TBI 11-2531-15



TBI 11-2532-15



TBI 11-2533-15
1 x 2



TBI 11-2534-15
1 x 2

ARTERY FORCEPS

Haemostatic Forceps — EN
 Arterienklemmen — DE
 Pinzas hemostáticas — ES



KELLY
14 cm/5 1/2"

KELLY-RANKIN
16 cm/6 1/4"

BABY-OVERHOLT
TBI 11-2539-13
13.5 cm/5 3/8"

CRILE
14 cm/5 1/2"

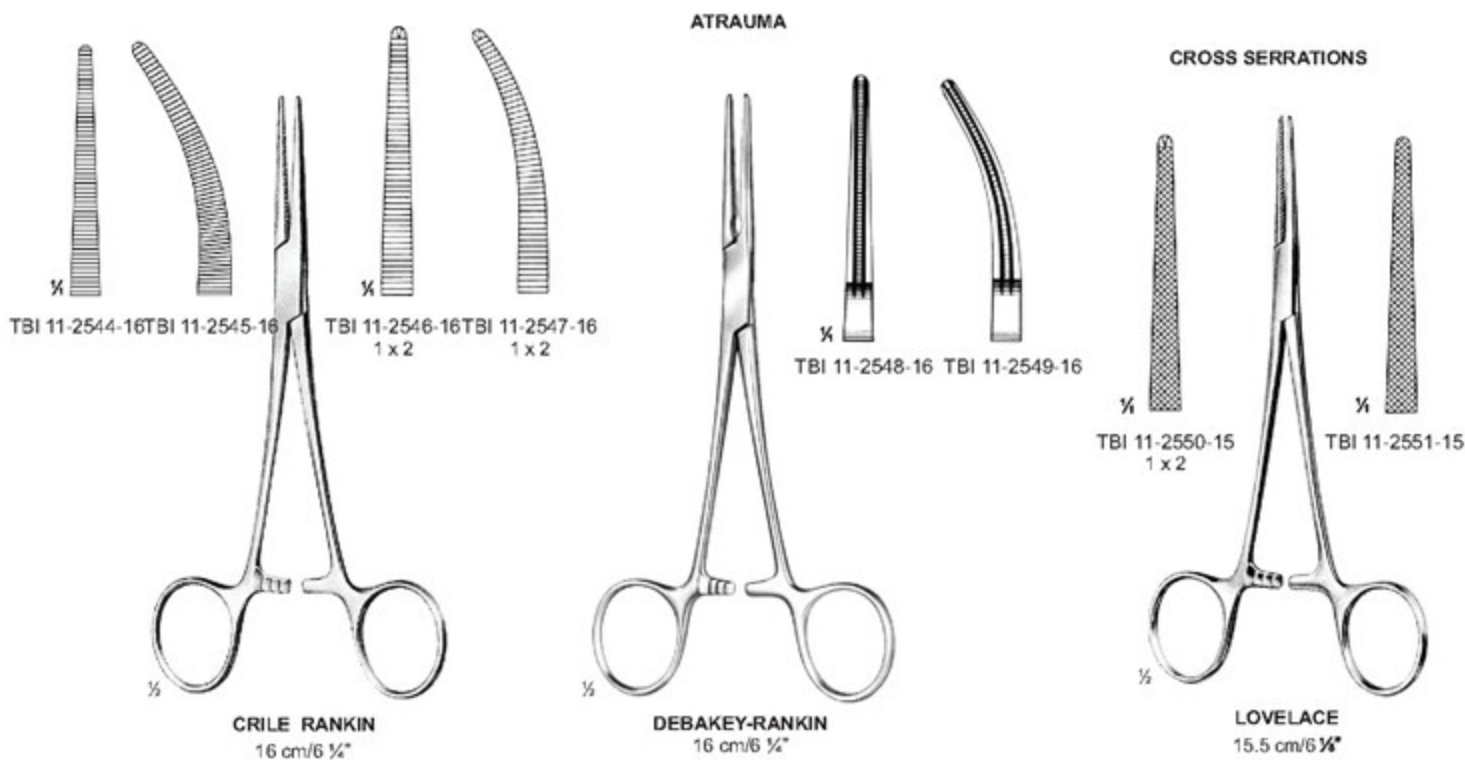

CRILE RANKIN
16 cm/6 1/4"

DEBAKEY-RANKIN
16 cm/6 1/4"

LOVELACE
15.5 cm/6 1/8"





SPENCER-WELLS/JONES



TBI 11-2552-13
13 cm/5 1/8"



TBI 11-2552-14
14.5 cm/5 3/4"



TBI 11-2552-15
15.5 cm/6 1/8"



TBI 11-2552-18
18.5 cm/7 1/4"



TBI 11-2552-20
20 cm/7 7/8"



TBI 11-2553-13
13 cm/5 1/8"



TBI 11-2553-14
14 cm/5 1/2"



TBI 11-2553-15
15 cm/5 7/8"



TBI 11-2553-18
18 cm/7 1/8"



TBI 11-2553-20
20 cm/7 7/8"



TBI 11-2554-13 TBI 11-2554-14 TBI 11-2554-17
13.5 cm/5 3/8" 14.5 cm/5 3/4" 17 cm/6 3/4"

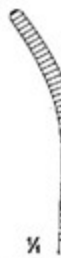

TBI 11-2555-13 TBI 11-2555-14 TBI 11-2555-16
13 cm/5 1/8" 14 cm/5 1/2" 16.5 cm/6 1/2"



Cm	In	Straight
18	7 1/8"	TBI 11-2557-18
20	7 7/8"	TBI 11-2557-20
22	8 1/2"	TBI 11-2557-22
24	9 1/2"	TBI 11-2557-24
26	10 1/4"	TBI 11-2557-26
28	11"	TBI 11-2557-28

Cm	In	Curved
18	7 1/8"	TBI 11-2558-18
20	7 7/8"	TBI 11-2558-20
22	8 1/2"	TBI 11-2558-22
24	9 1/2"	TBI 11-2558-24
26	10 1/4"	TBI 11-2558-26
28	11"	TBI 11-2558-28



TBI 11-2559-18
1 x 2



TBI 11-2560-18
1 x 2

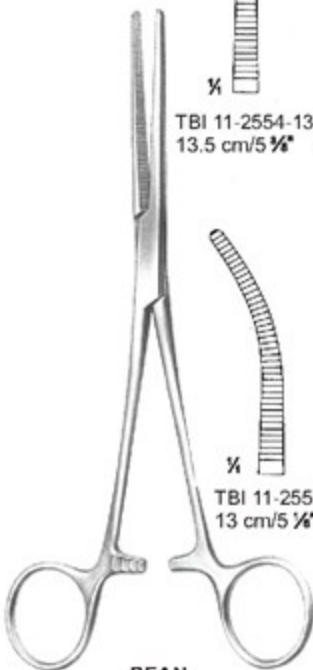

PEAN
DELICATE PATTERN

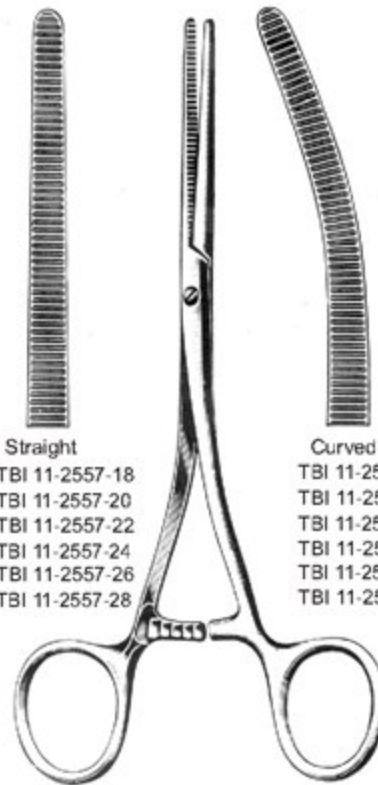

PEAN

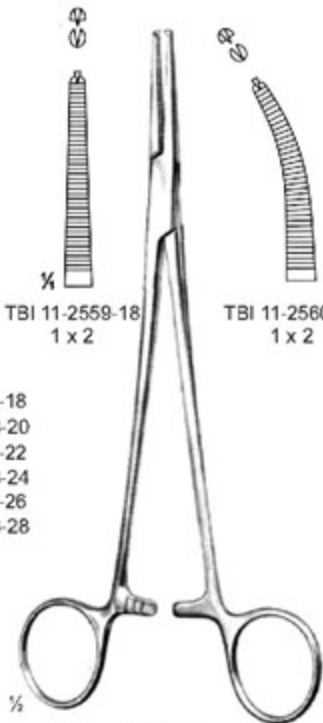

ADSON
18.5 cm/7 1/4"

ARTERY FORCEPS

Haemostatic Forceps — EN
 Arterienklemmen — DE
 Pinzas hemostáticas — ES

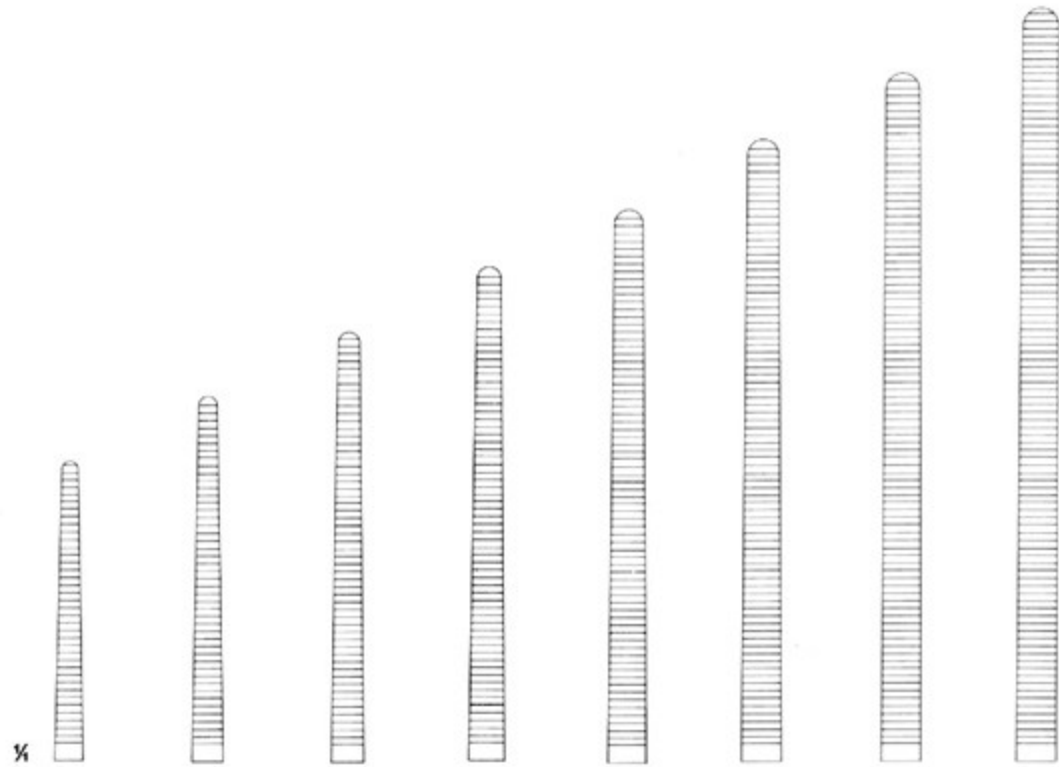

TBI 11-2561-14 TBI 11-2561-16 TBI 11-2561-18 TBI 11-2561-20 TBI 11-2561-22 TBI 11-2561-24 TBI 11-2561-26 TBI 11-2561-30
 14.5 cm/5 1/4" 16.5 cm/6 1/2" 18.5 cm/7 1/4" 20.5 cm/8 1/8" 22.5 cm/8 3/4" 24.5 cm/9 5/8" 26 cm/10 1/4" 30.5 cm/12"



ROCHESTER-PEAN

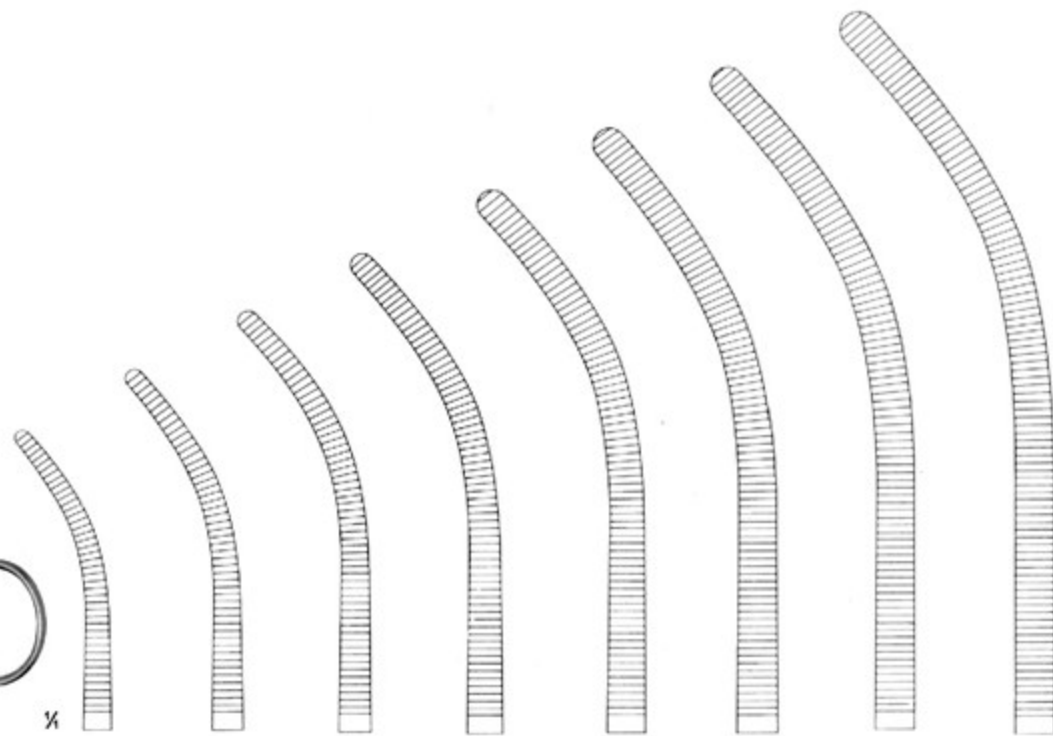

TBI 11-2562-14 TBI 11-2562-16 TBI 11-2562-18 TBI 11-2562-20 TBI 11-2562-22 TBI 11-2562-24 TBI 11-2562-26 TBI 11-2562-30
 14.5 cm/5 1/4" 16.5 cm/6 1/2" 18.5 cm/7 1/4" 20.5 cm/8 1/8" 22.5 cm/8 3/4" 24.5 cm/9 5/8" 26 cm/10 1/4" 30.5 cm/12"



ATRAUMA



DEBAKEY-PEAN

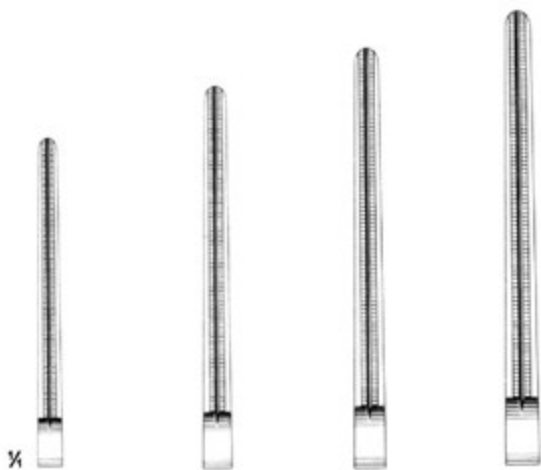

TBI 11-2563-14 14.5 cm/5 3/4"
 TBI 11-2563-16 16.5 cm/6 1/2"
 TBI 11-2563-18 18.5 cm/7 1/4"
 TBI 11-2563-20 20.5 cm/8 1/4"



DEBAKEY-PEAN

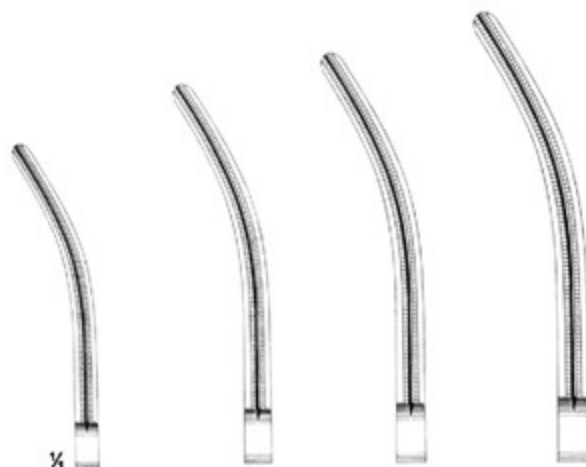

TBI 11-2564-14 14.5 cm/5 3/4"
 TBI 11-2564-16 16.5 cm/6 1/2"
 TBI 11-2564-18 18.5 cm/7 1/4"
 TBI 11-2564-20 20.5 cm/8 1/4"

ARTERY FORCEPS

Haemostatic Forceps — EN
 Arterienklemmen — DE
 Pinzas hemostáticas — ES

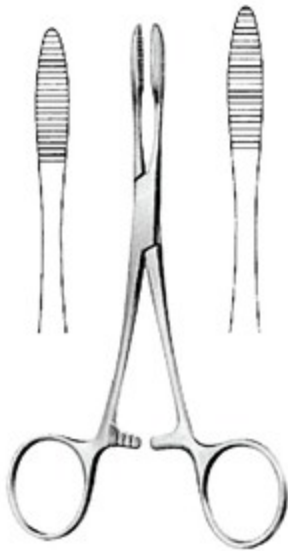

PEAN
 TBI 11-2565-14 14 cm/5 1/2"
 TBI 11-2565-16 16 cm/6 1/4"



KOCHER
 Delicate Pattern
 1 : 2

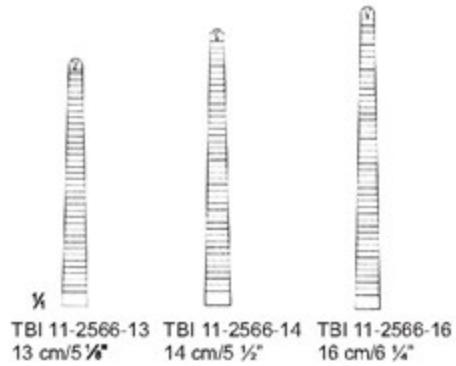

TBI 11-2566-13 13 cm/5 1/8"
 TBI 11-2566-14 14 cm/5 1/2"
 TBI 11-2566-16 16 cm/6 1/4"

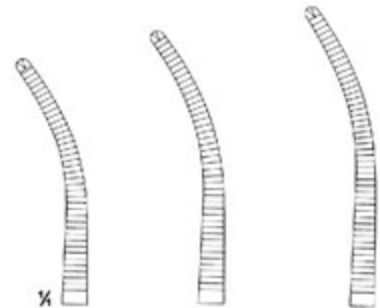

TBI 11-2567-13 13 cm/5 1/8"
 TBI 11-2567-14 14 cm/5 1/2"
 TBI 11-2567-16 16 cm/6 1/4"



KOCHER



1 x 2

TBI 11-2568-18 18 cm/7 1/8"
 TBI 11-2568-20 20 cm/7 7/8"
 TBI 11-2568-22 22 cm/8 1/2"
 TBI 11-2568-24 24 cm/9 1/2"
 TBI 11-2568-26 26 cm/10 1/4"



1 x 2

KOCHER (STANDARD)

TBI 11-2570-13 13 cm/5 1/8"
 TBI 11-2570-14 14 cm/5 1/2"
 TBI 11-2571-14 14.5cm/5 3/4"

TBI 11-2572-13
 TBI 11-2572-14
 TBI 11-2573-14



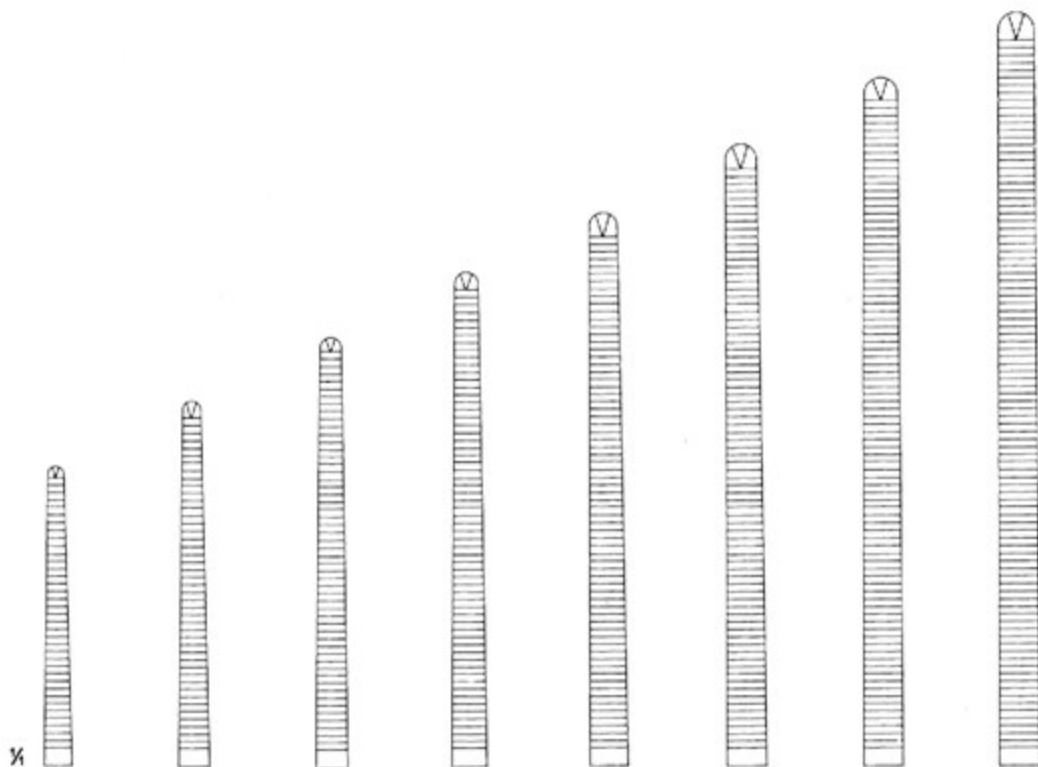

TBI 11-2574-16 16 cm/6 1/4" TBI 11-2574-18 18 cm/7 1/8" TBI 11-2574-20 20 cm/7 7/8" TBI 11-2574-22 22 cm/8 1/2" TBI 11-2574-24 24 cm/9 1/2" TBI 11-2574-26 26 cm/10 1/4" TBI 11-2574-28 28 cm/11" TBI 11-2574-30 30 cm/11 3/4"



KOCHER OCHSNER
1 : 2

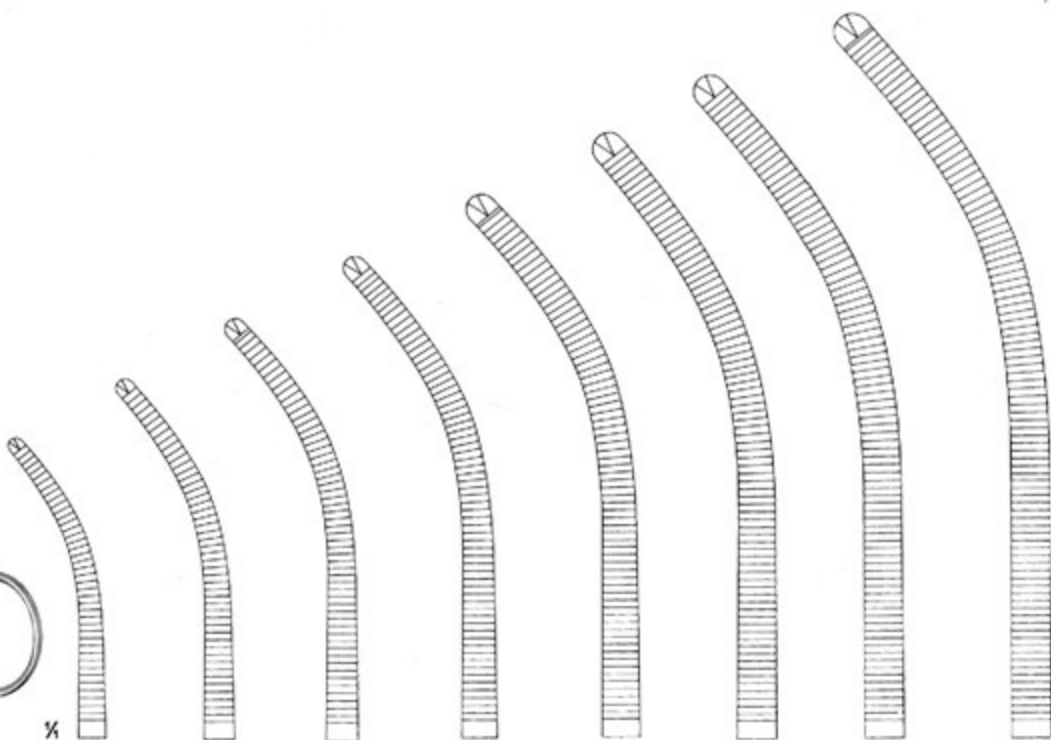

TBI 11-2575-16 16 cm/6 1/4" TBI 11-2575-18 18 cm/7 1/8" TBI 11-2575-20 20 cm/7 7/8" TBI 11-2575-22 22 cm/8 1/2" TBI 11-2575-24 24 cm/9 1/2" TBI 11-2575-26 26 cm/10 1/4" TBI 11-2575-28 28 cm/11" TBI 11-2575-30 30 cm/11 3/4"



CHAPUT
TBI 11-2576-13
13 cm/5 1/8"



TUFFIER
TBI 11-2577-13
13 cm/5 1/8"

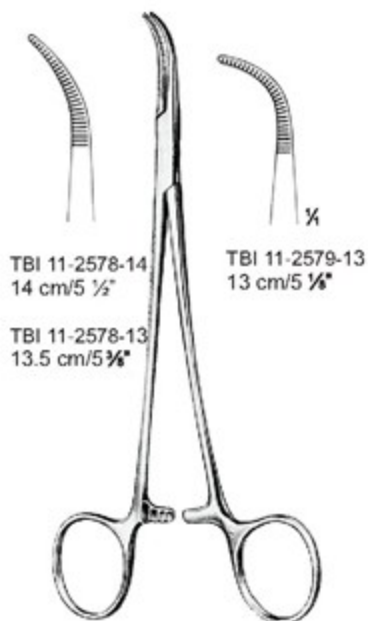

TBI 11-2578-14
14 cm/5 1/2"
TBI 11-2578-13
13.5 cm/5 3/8"

BABY-MIXTER

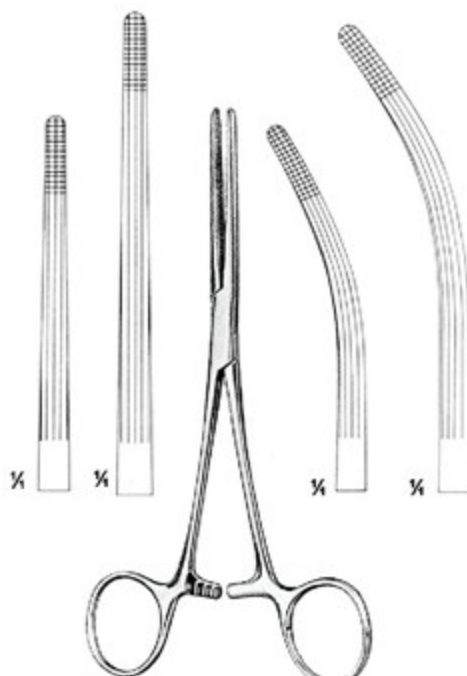

ROCHESTER-CARMALT
TBI 11-2580-16 16 cm/6 1/4" TBI 11-2581-16
TBI 11-2580-20 20 cm/7 7/8" TBI 11-2581-20

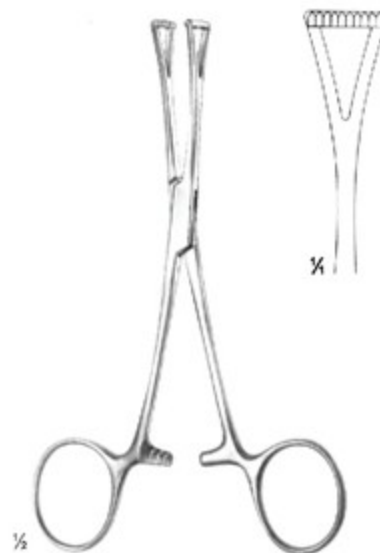

COLLIN
TBI 11-2582-14
14 cm/5 1/2"





BIRKET
18.5 cm / 7 1/4"

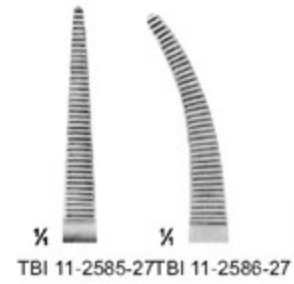
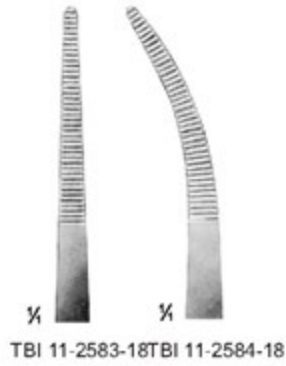

BENGOLEA

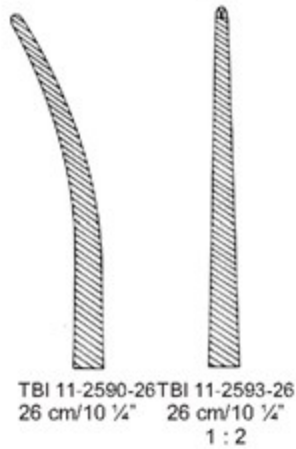
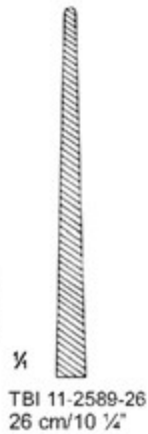
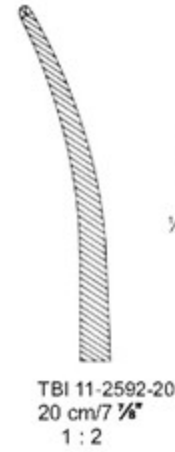
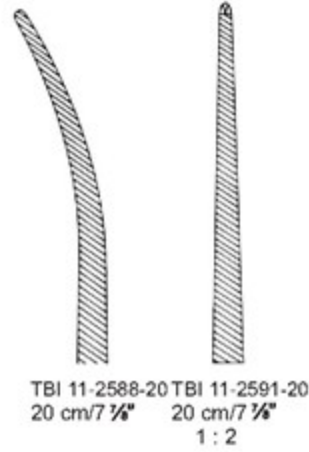
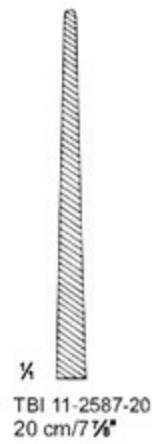

BRIDGE
27.5 cm / 10 3/4"



ARTERY FORCEPS



PENNINGTON
TBI 11-2595-15 15.5 cm/6 1/8"
TBI 11-2595-20 20 cm/7 7/8"

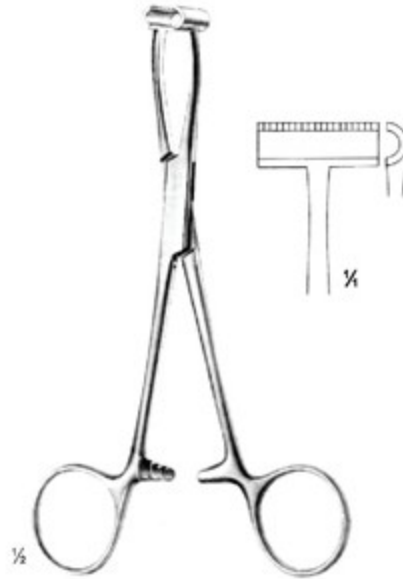

PRATT
TBI 11-2596-15
15 cm/5 7/8"

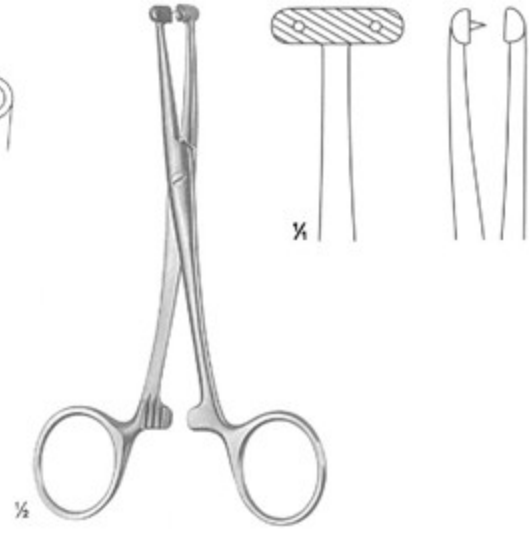

MARTEL
TBI 11-2597-14
14 cm/5 1/2"



WILLET-MARTEL
TBI 11-2598-19
19 cm/7 1/2"

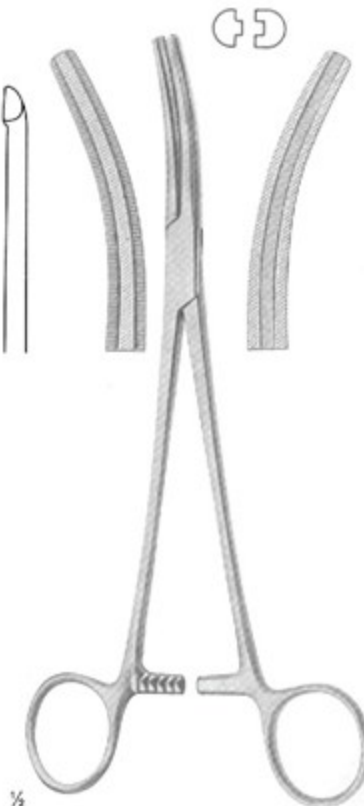

BUIE
TBI 11-2599-21
21 cm/8 1/4"

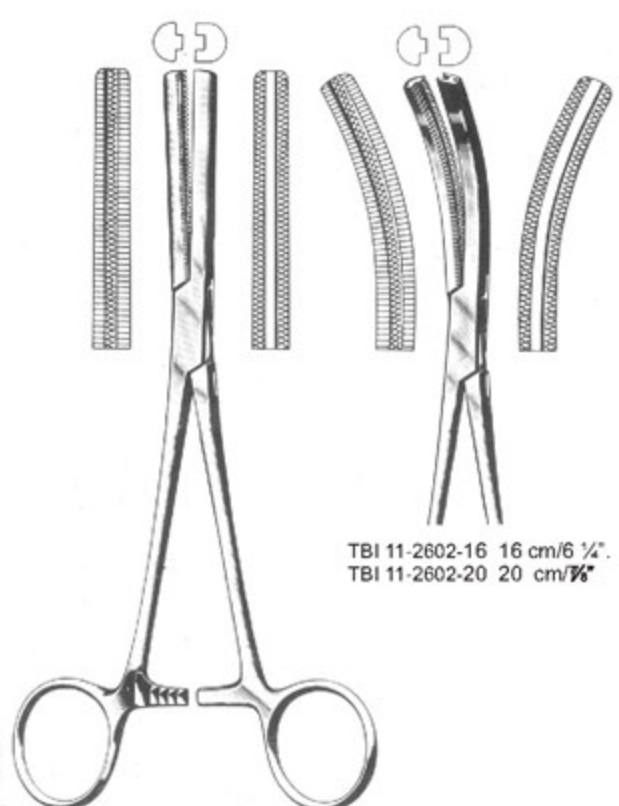

FERGUSSON
TBI 11-2600-16 16 cm/6 1/4"
TBI 11-2600-20 20 cm/7 7/8"

TBI 11-2602-16 16 cm/6 1/4"
TBI 11-2602-20 20 cm/7 7/8"



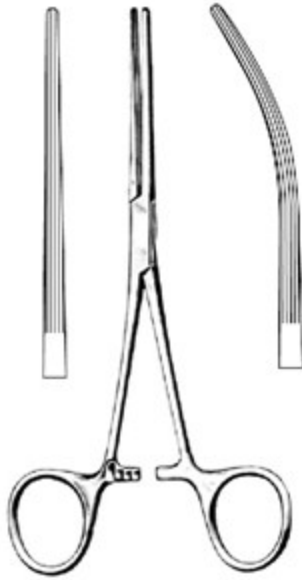

BAINBRIDGE

TBI 11-2603-15 15 cm/5 7/8" TBI 11-2604-15
 TBI 11-2603-18 18.5 cm/7 1/4" TBI 11-2604-18

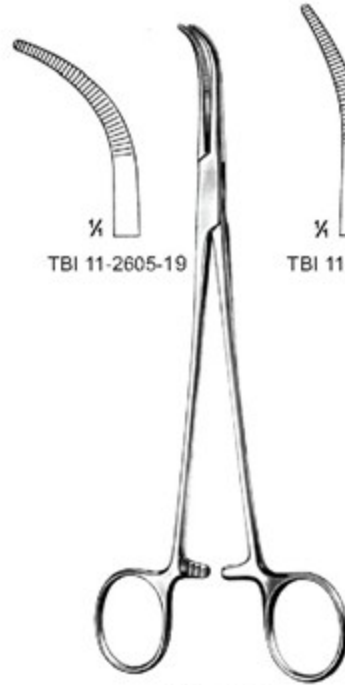

SCHNIDT

19 cm/7 1/2"

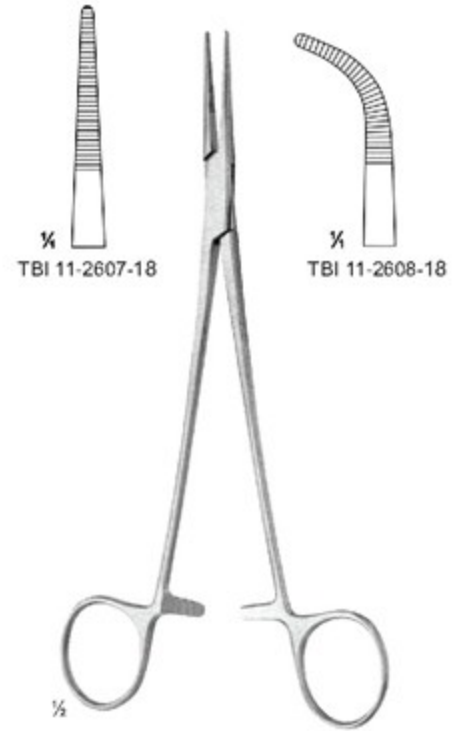

ADSON

18.5 cm/7 1/4"

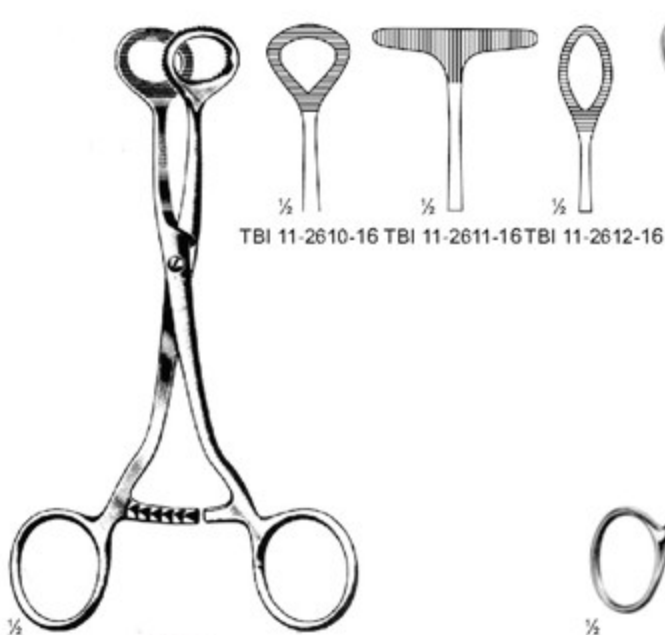

COLLIN

TBI 11-2609-16
 16 cm/6 1/4"

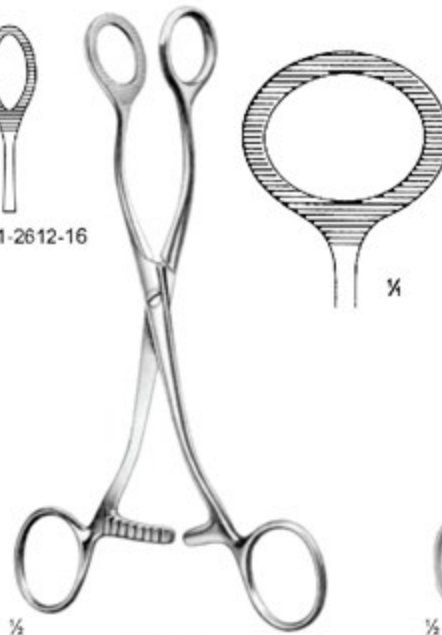

COLLIN

TBI 11-2613-16
 16.5 cm/6 1/2"

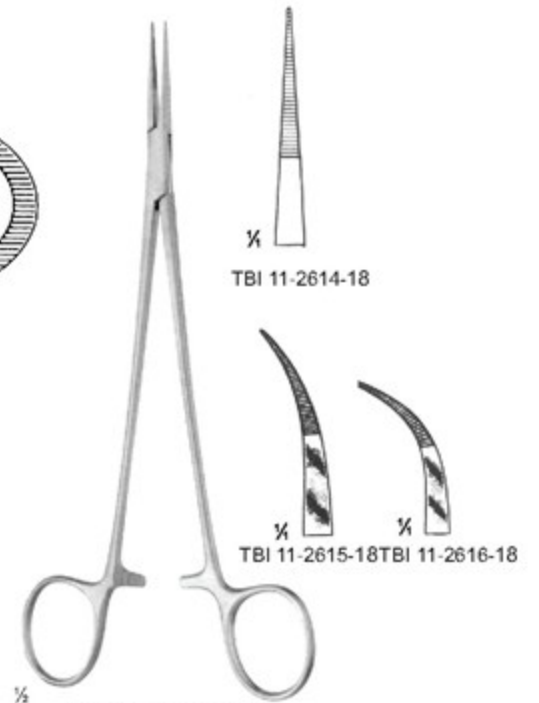

JACOBSON-MICRO

18 cm/7 1/8"





BABY-MIXTER
 TBI 11-2617-18
 18 cm/7 1/8"



MICRO-ADSON
 TBI 11-2618-14
 14 cm/5 1/2"

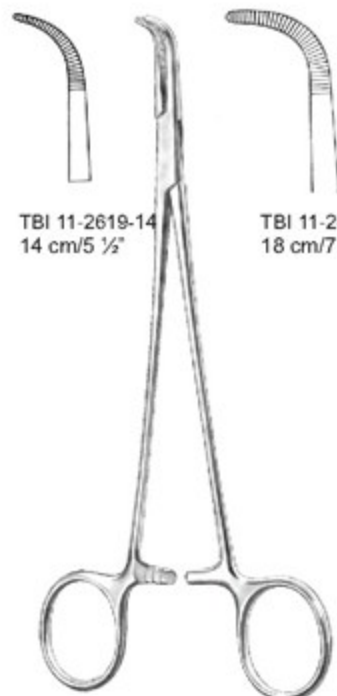

TBI 11-2619-14
 14 cm/5 1/2" TBI 11-2619-18
 18 cm/7 1/8"

ADSON-BABY

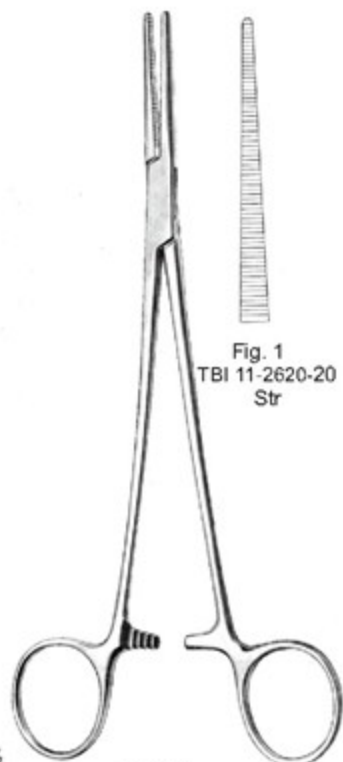

HEISS
 20 cm/7 7/8"



Fig. 1
 TBI 11-2620-20
 Str



Fig. 2
 TBI 11-2621-20
 Slightly Cvd

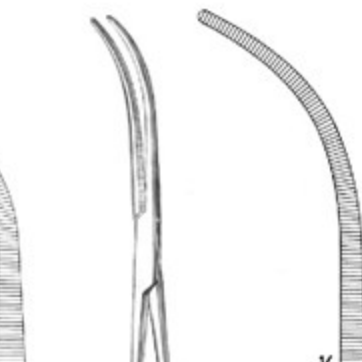
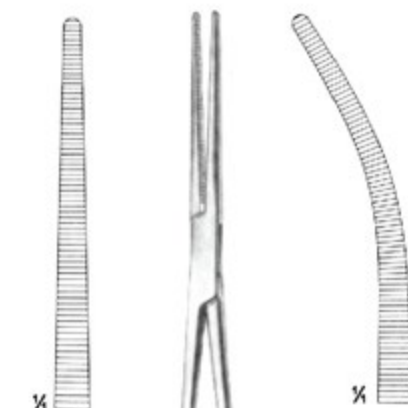

Fig. 3
 TBI 11-2622-20
 Cvd



OVERHOLT-MIXTER
 TBI 11-2623-21
 21 cm/8 1/4"



TBI 11-2624-22

TBI 11-2625-22

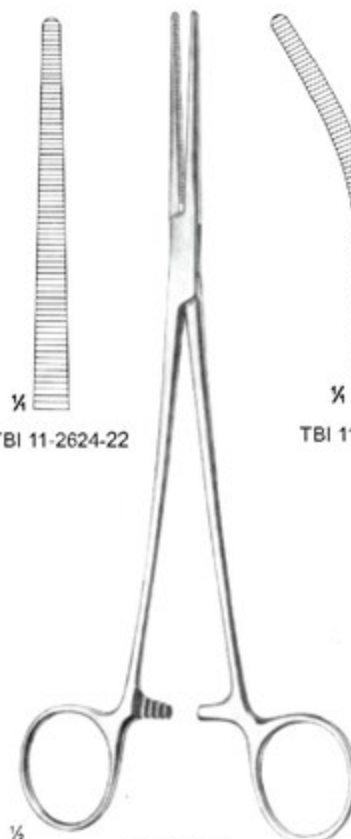

ROBERTS
 22 cm/8 1/2"





MCQUIGG-MIXTER
 TBI 11-2626-23
 23.5 cm/9 1/4"



LAHEY
 TBI 11-2627-18
 18.5 cm/7 1/4"



LAHEY



TBI 11-2628-19
 19.5 cm/7 1/2"



TBI 11-2629-22
 22.5 cm/8 3/4"

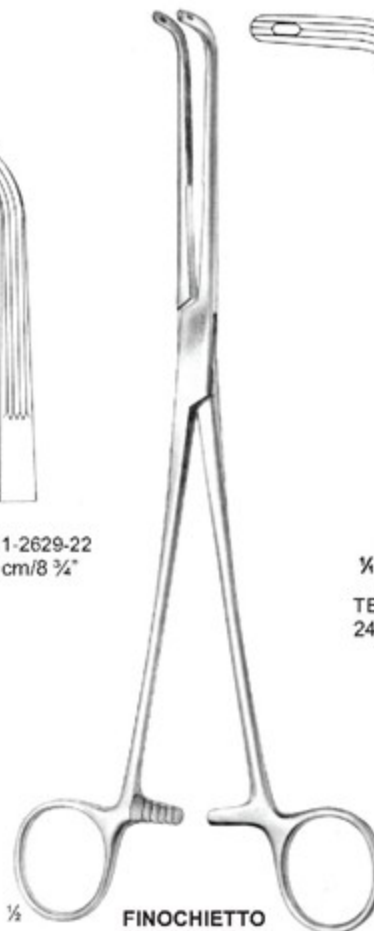

FINOCHIETTO



TBI 11-2630-24
 24.5 cm/9 3/4"



MIXTER-BABY
 TBI 11-2631-14
 14 cm/5 1/2"



KELLY



Fig. 1
 TBI 11-2632-19
 19 cm/7 1/2"



Fig. 1
 TBI 11-2632-22
 22.5 cm/8 1/4"



Fig. 1
 TBI 11-2632-24
 24.5 cm/9 1/4"



Fig. 2
 TBI 11-2633-19
 19 cm/7 1/2"



Fig. 2
 TBI 11-2633-22
 22 cm/8 1/2"



Fig. 2
 TBI 11-2633-23
 23.5 cm/9 1/4"



Fig. 3
 TBI 11-2634-18
 18.5 cm/7 1/4"



Fig. 3
 TBI 11-2634-21
 21.5 cm/8 1/2"



Fig. 3
 TBI 11-2634-23
 23.5 cm/9 1/4"





LAWRENCE
TBI 11-2635-28
28 cm/11"



WIKSTROEM



TBI 11-2636-21
21 cm/8 1/4"



TBI 11-2636-24
24.5 cm/9 1/2"



MEEKER
TBI 11-2637-28
28 cm/11"



MIXTER-CRAFOORD
TBI 11-2638-25 25 cm/9 7/8"
TBI 11-2638-27 27 cm/10 1/2"



MINI-GEMINI

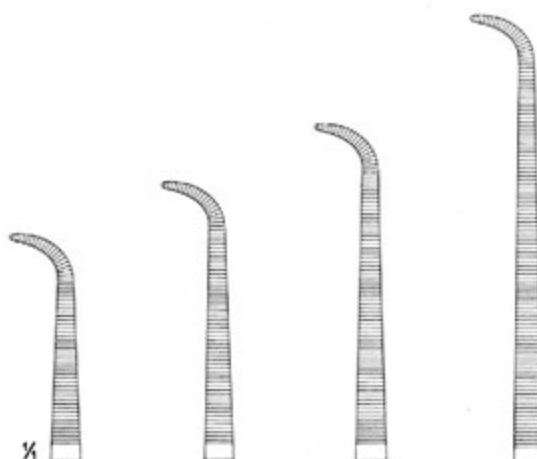

TBI 11-2639-18 18 cm/7 1/8"
 TBI 11-2639-22 22.5 cm/8 3/4"
 TBI 11-2639-25 25 cm/9 1/4"
 TBI 11-2639-28 28.5 cm/11 1/4"



GEMINI

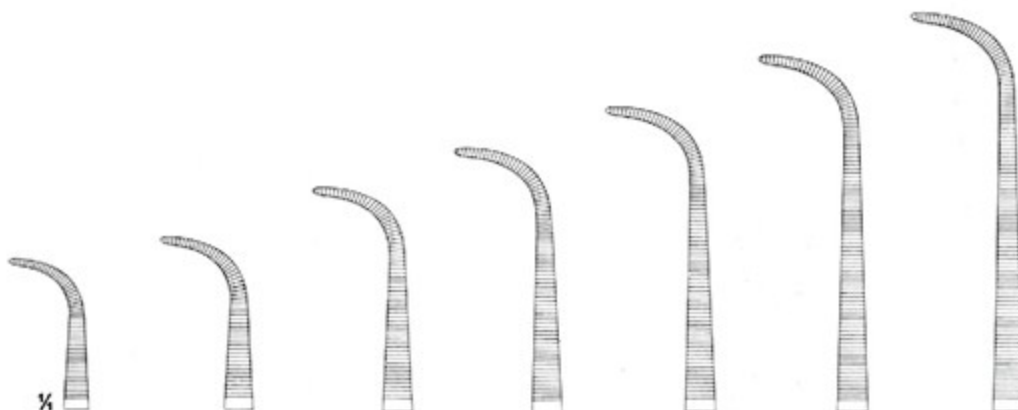

TBI 11-2640-13 13 cm/5 1/8"
 TBI 11-2640-16 16 cm/6 1/4"
 TBI 11-2640-18 18 cm/7 1/8"
 TBI 11-2640-21 21 cm/8 1/4"
 TBI 11-2640-23 23 cm/9"
 TBI 11-2640-25 25 cm/9 1/4"
 TBI 11-2640-28 28 cm/11"

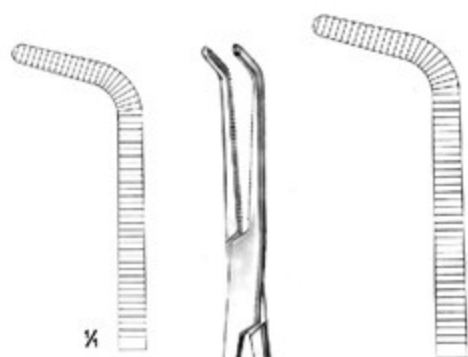
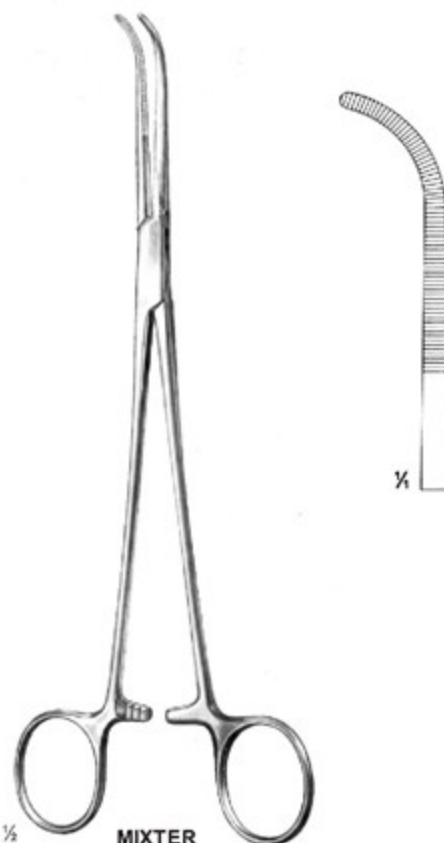

 $\frac{1}{4}$
MIXTERTBI 11-2641-14 14.5 cm/5 $\frac{3}{4}$ "TBI 11-2641-15 15.5 cm/6 $\frac{1}{8}$ "TBI 11-2641-19 19 cm/7 $\frac{1}{2}$ "
 $\frac{1}{4}$
MIXTER

TBI 11-2642-22

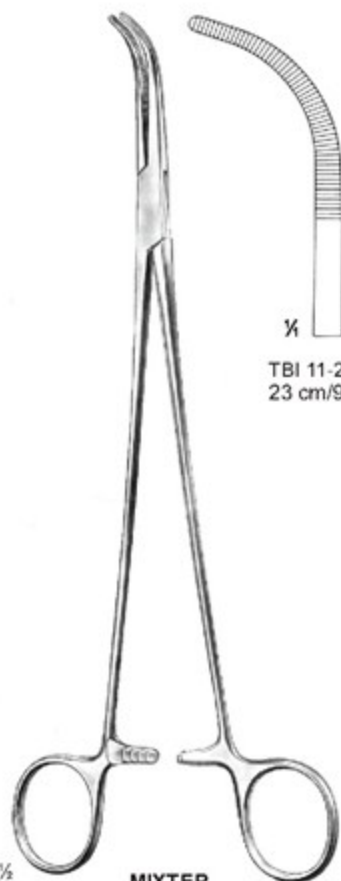
22 cm/8 $\frac{1}{2}$ "
 $\frac{1}{4}$

TBI 11-2643-23

23 cm/9"



 $\frac{1}{4}$

Fig. 1

TBI 11-2644-22
22 cm/8 $\frac{1}{2}$ "

2

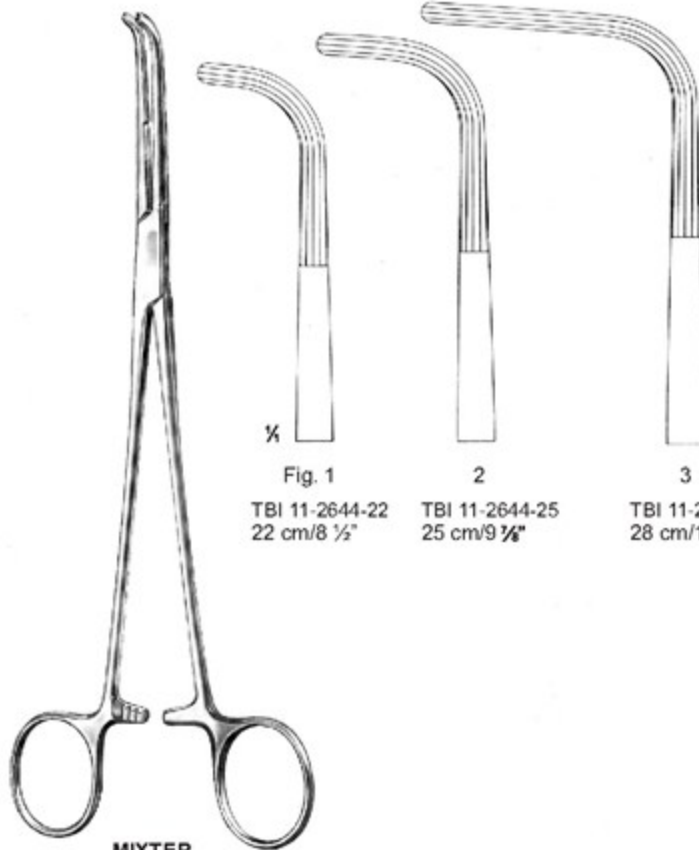
TBI 11-2644-25
25 cm/9 $\frac{1}{8}$ "

3

TBI 11-2644-28
28 cm/11"**MIXTER****MIXTER**



O'SHAUGNESSY



TBI 11-2645-15
 15 cm/5 7/8"



TBI 11-2645-18
 18 cm/7 1/4"



TBI 11-2645-19
 18.5 cm/7 1/4"



TBI 11-2645-20
 20 cm/7 7/8"



TBI 11-2645-23
 23 cm/9"



TBI 11-2645-26
 26 cm/10 1/4"



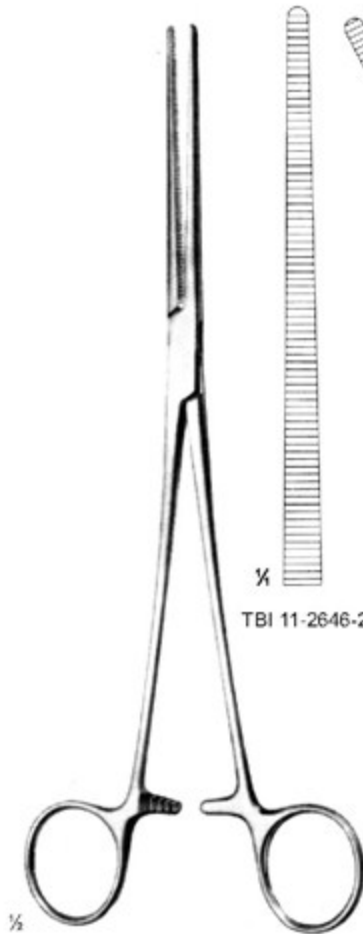

SAROT
24 cm/9 1/2"

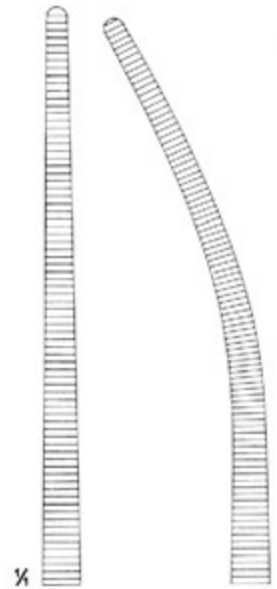

1/4 TBI 11-2646-24

TBI 11-2647-24

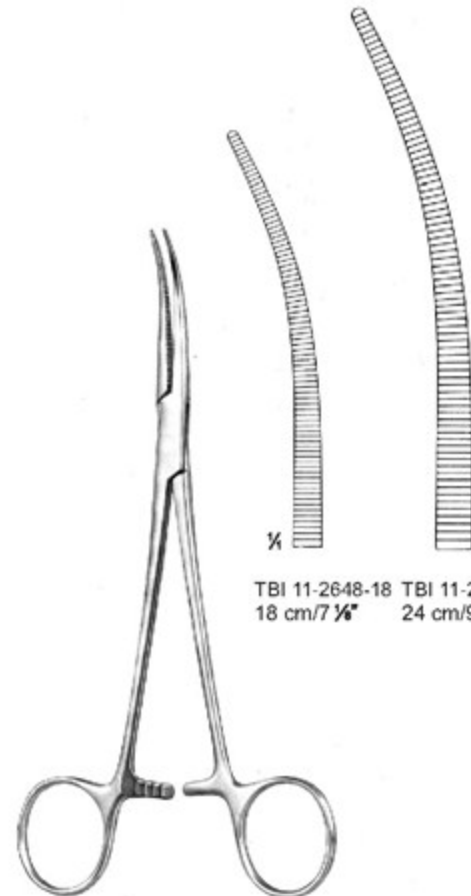

CRAFOORD

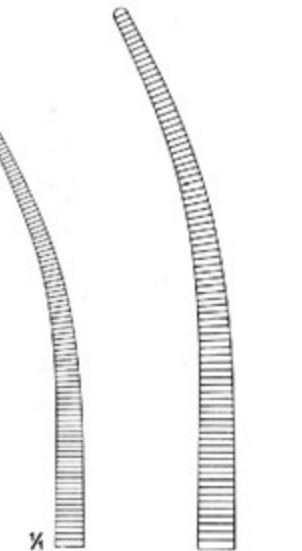

TBI 11-2648-18 18 cm/7 1/8" TBI 11-2648-24 24 cm/9 1/2"



CRAFOORD-SELLORS
 24 cm/9 1/2"
 Vascular Clamp



TBI 11-2649-24



TBI 11-2650-24

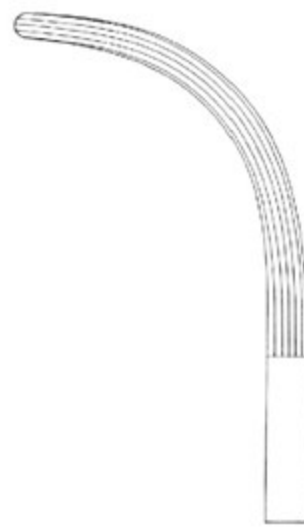

TBI 11-2651-24



JOHNS HOPKINS
 TBI 11-2652-20
 20 cm/7 7/8"

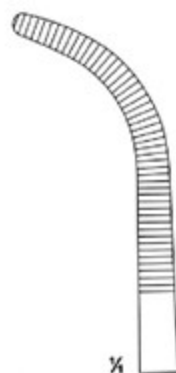

TBI 11-2653-29
 29.5 cm/11 5/8"

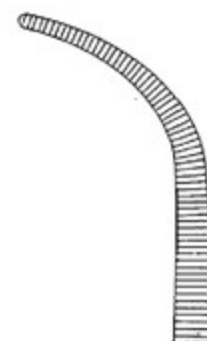

TBI 11-2653-28
 28.5 cm/11 1/4"

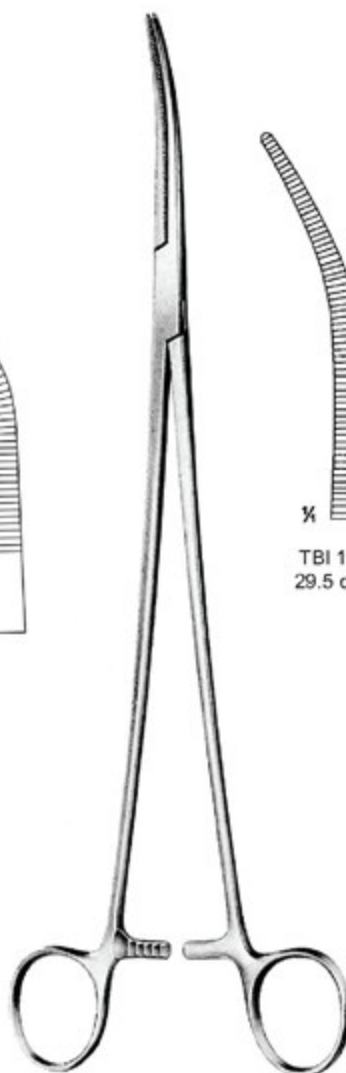

ZENKER



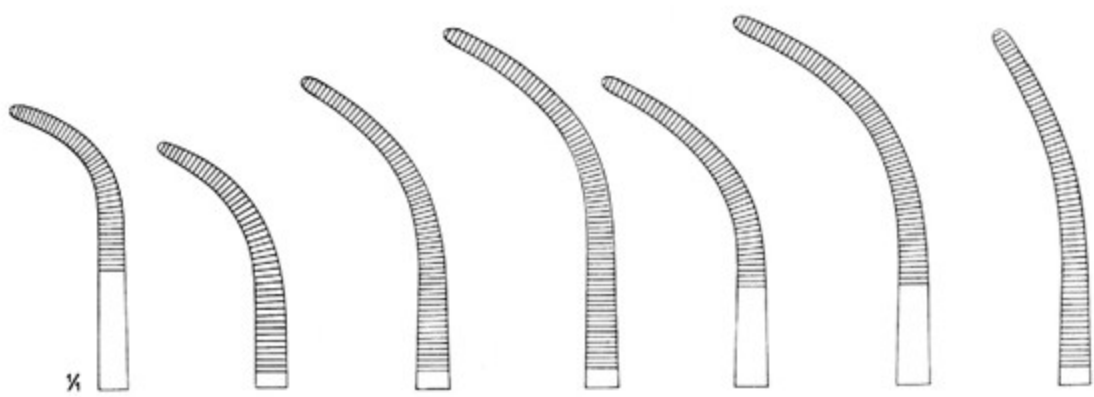

Fig. 1 TBI 11-2654-20 20.5 cm/8 1/8"
 Fig. 2 TBI 11-2655-20 20 cm/7 7/8"
 Fig. 3 TBI 11-2655-21 21.5 cm/8 1/2"
 Fig. 4 TBI 11-2655-22 22 cm/8 1/2"
 Fig. 5 TBI 11-2656-21 21.5 cm/8 1/2"
 Fig. 6 TBI 11-2656-22 22 cm/8 1/2"
 Fig. 7 TBI 11-2657-22 22 cm/8 1/2"



OVERHOLT-GEISSENDORFER

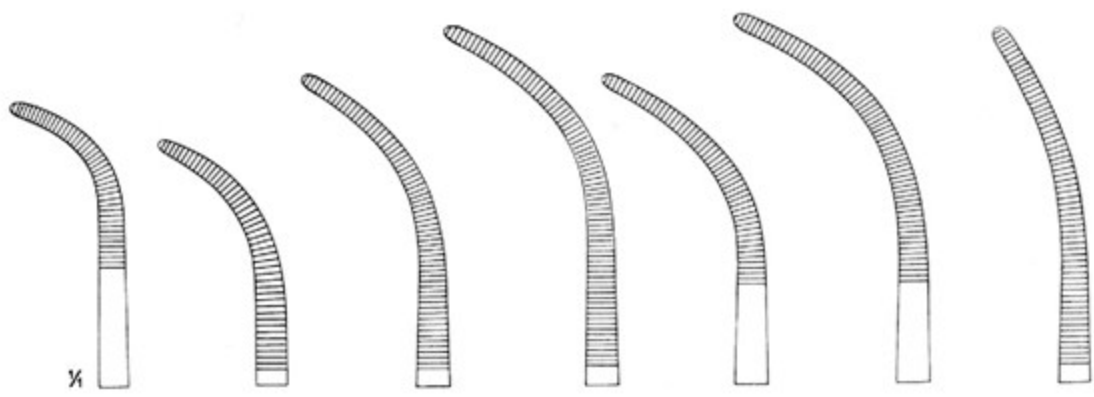
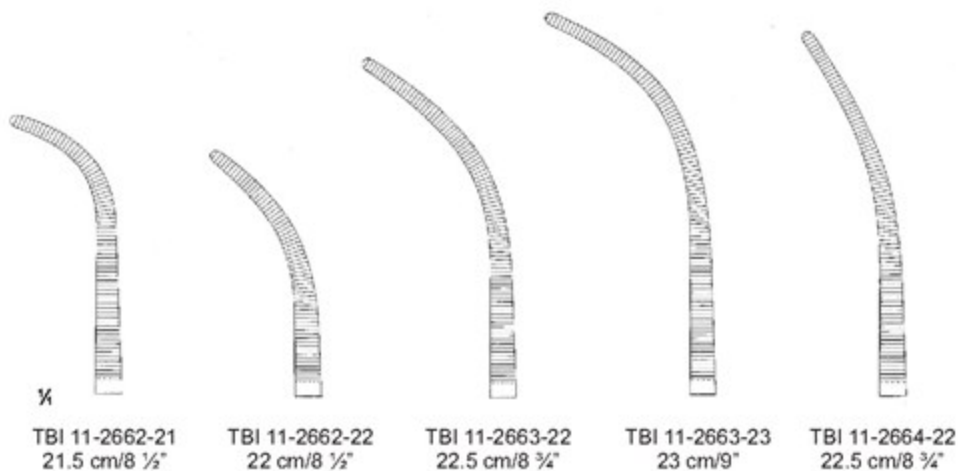

Fig. 1 TBI 11-2658-27 27 cm/10 1/2"
 Fig. 2 TBI 11-2658-26 26.5 cm/10 3/8"
 Fig. 3 TBI 11-2659-27 27.5 cm/10 3/4"
 Fig. 4 TBI 11-2659-28 28 cm/11"
 Fig. 5 TBI 11-2660-27 27.5 cm/10 3/4"
 Fig. 6 TBI 11-2660-28 28 cm/11"
 Fig. 7 TBI 11-2661-28 27.5 cm/10 3/4"



OVERHOLT-FINO



OVERHOLT-SLIM

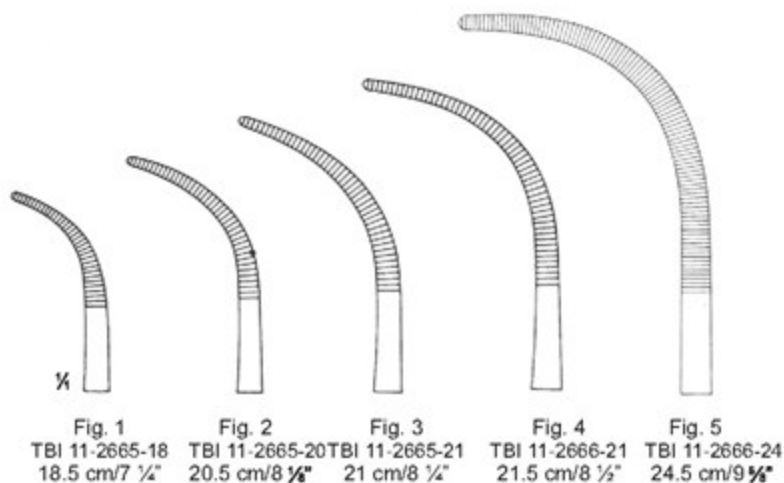



RUMEL
23 cm/9"

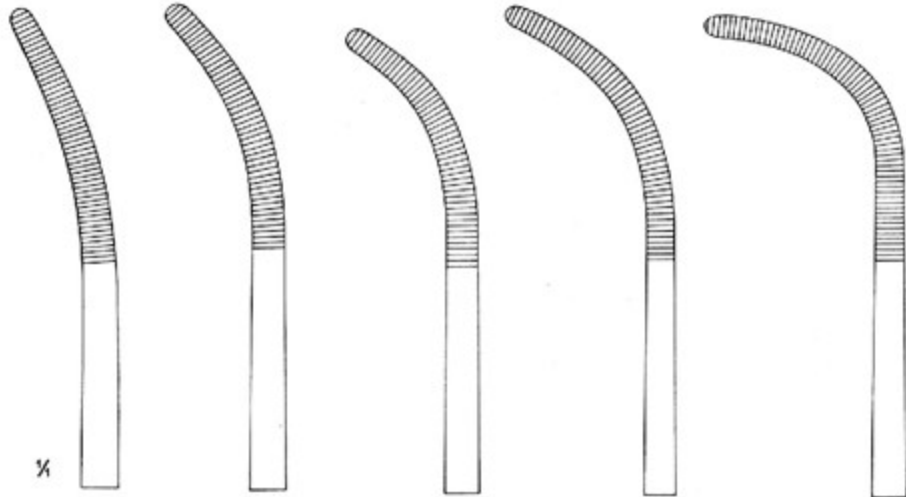

TBI 11-2667-23 TBI 11-2668-23 TBI 11-2669-23 TBI 11-2670-23 TBI 11-2671-23

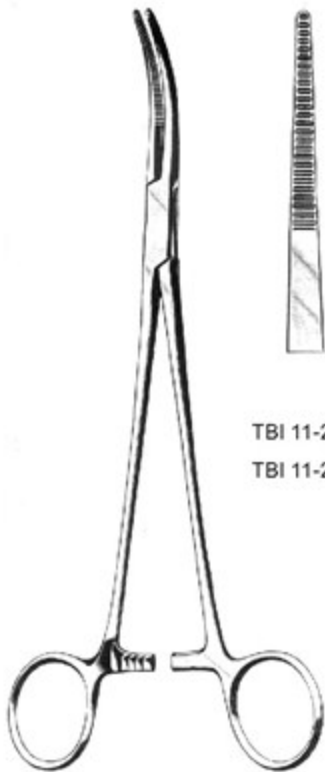

TBI 11-2672-21
TBI 11-2672-26



TOENNIS

TBI 11-2673-21 1.0 cm 8 1/4"
TBI 11-2673-26 6.0 cm 10 1/4"



TOENNIS

TBI 11-2674-21 1:2
TBI 11-2674-26 TBI 11-2675-21
TBI 11-2675-26

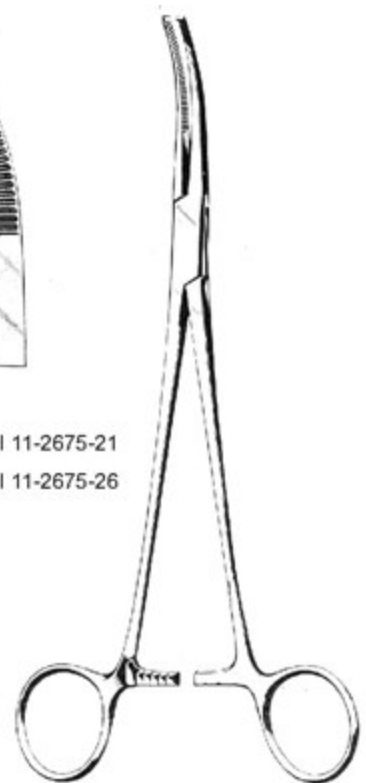



GUYON

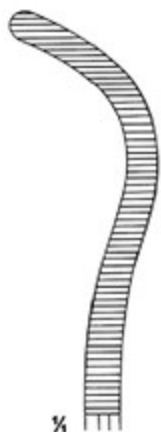

TBI 11-2676-20
 20 cm/7 7/8"

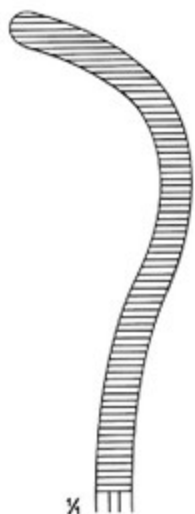

TBI 11-2676-22
 22 cm/8 1/2"



TBI 11-2676-24
 24 cm/9 1/2"



GUYON
 TBI 11-2677-23
 23 cm/9"

ATRAUMA



GUYON
 ATRAUMA



TBI 11-2678-23
 23 cm/9"



TBI 11-2678-24
 24 cm/9 1/2"



- EN — Hysterectomy Forceps, Kidney Pedicle Clamps
 DE — Hysterektomieklemmen, Nierenstielklemmen
 ES — Pinzas para histerectomia, Pinzas para pedículo renal

ARTERY FORCEPS

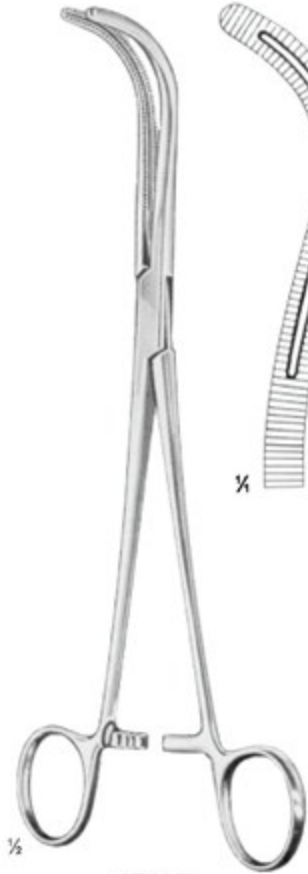

STILLE
TBI 11-2679-23
23 cm/9"

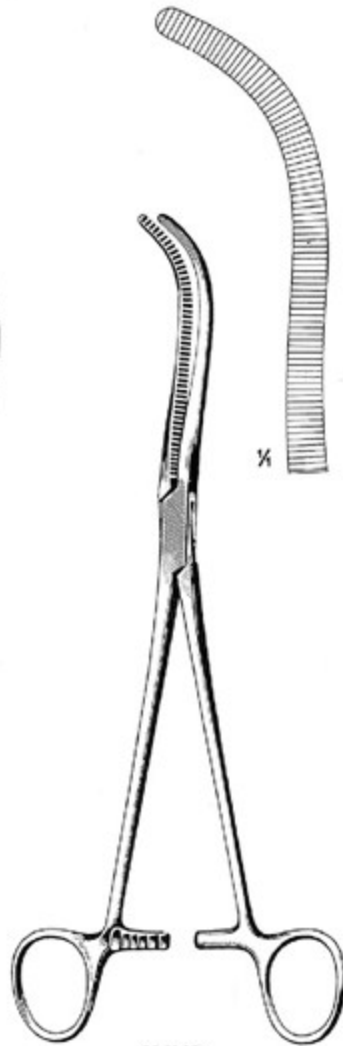

MAYO
TBI 11-2680-23
23 cm/9"

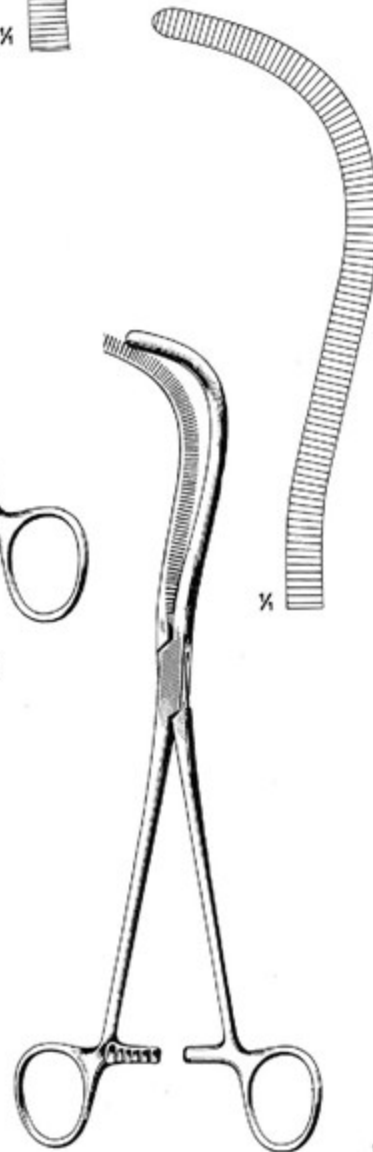

MAYO-GUYON
TBI 11-2681-23
23 cm/9"

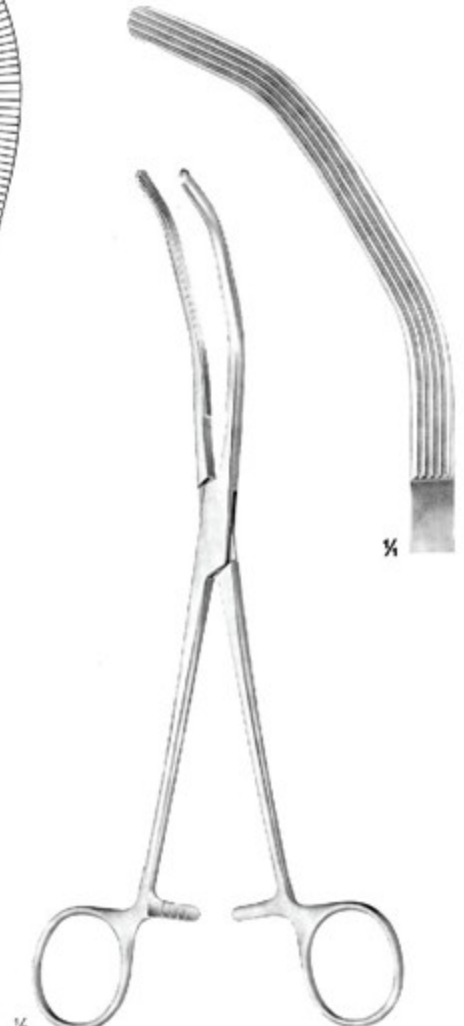

HERRICK
TBI 11-2682-23
23 cm/9"

ARTERY FORCEPS

Hysterectomy Forceps, Kidney Pedicle Clamps

Hysterektomieklemmen, Nierenstielklemmen

Pinzas para histerectomia, Pinzas para pedículo renal

EN

DE

ES



STILLE
TBI 11-2683-22
22 cm/8 1/2"

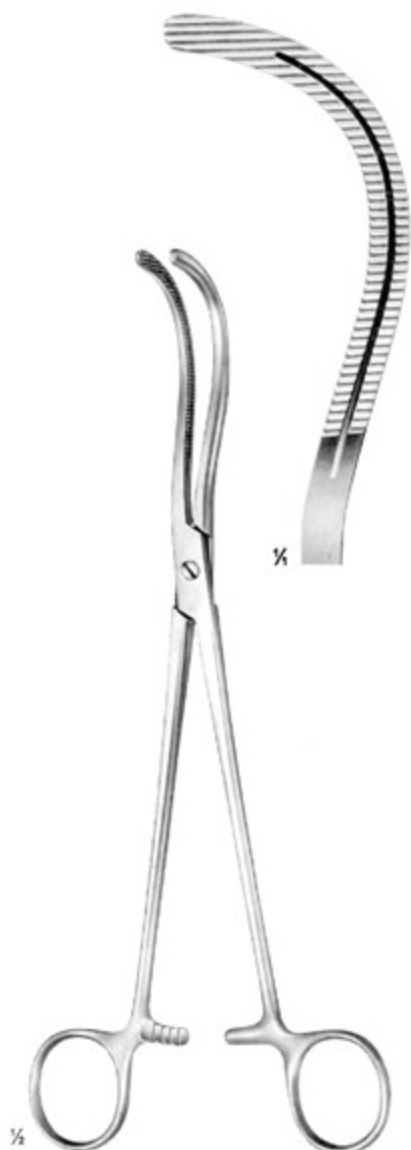

STILLE
TBI 11-2684-24
24 cm/9 1/2"
Screw Joint



GUYON
TBI 11-2685-26
26.5 cm/10 3/8"





GRAY

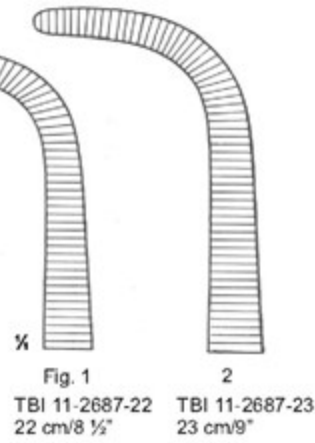

GRAY
1:2

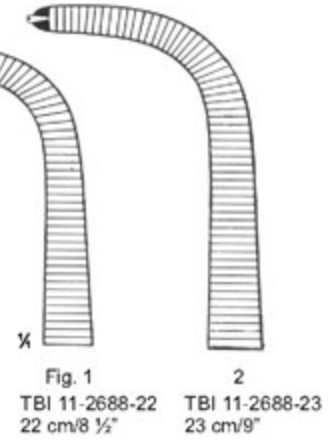

DESJARDINS
TBI 11-2689-21
21 cm/8 1/4"



DESJARDINS
TBI 11-2690-21
21 cm/8 1/4"

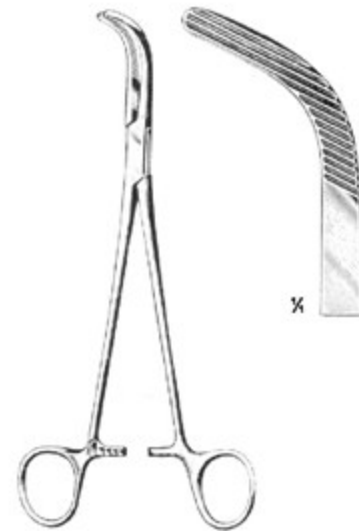

CRILE
TBI 11-2691-20
20 cm/7 1/2"



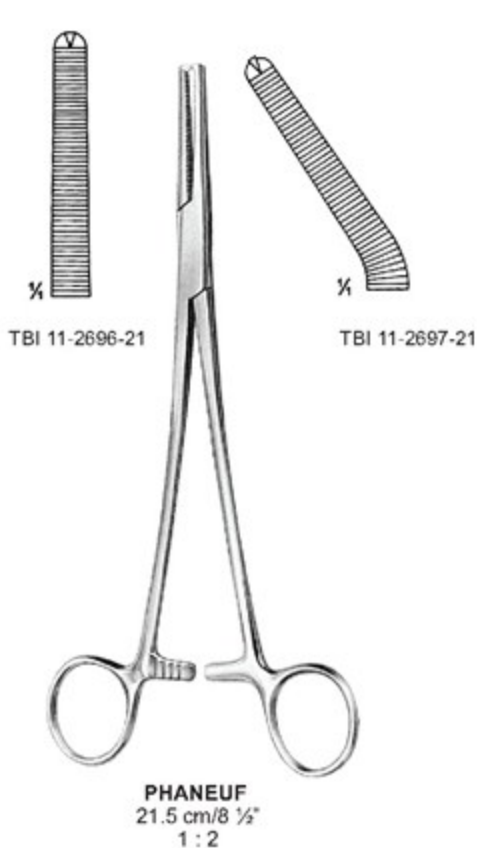
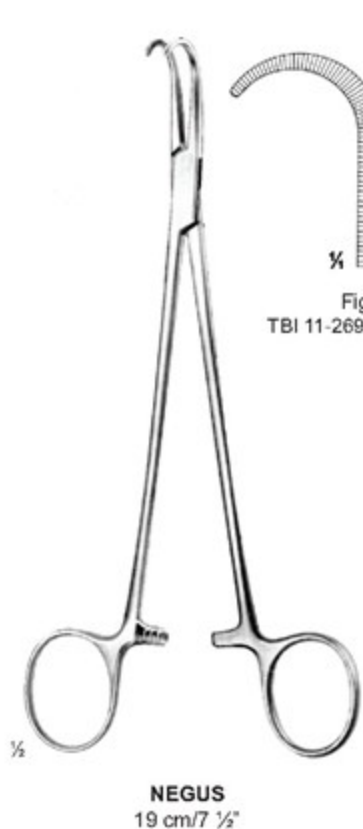
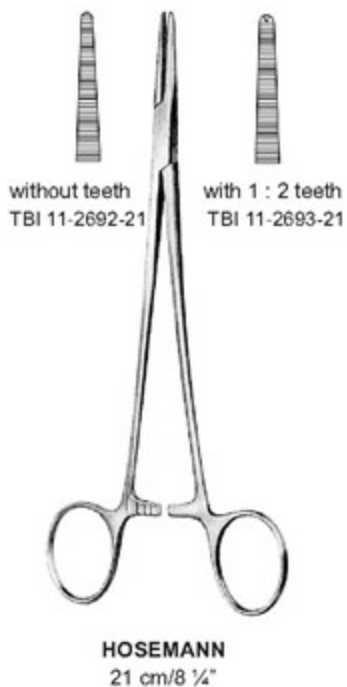



1 Tooth	HEANEY	2 Teeth
TBI 11-2698-19	19.5 cm/7 1/2"	TBI 11-2699-19
TBI 11-2698-21	21.0 cm/8 1/4"	TBI 11-2699-21
TBI 11-2698-23	23.0 cm/9"	TBI 11-2699-23

WERTHEIM-CULLEN
 TBI 11-2700-21
 21.5 cm/8 1/2"

WERTHEIM
 TBI 11-2701-24
 24 cm/9 1/2"
 Extra Strong



ROGERS



Fig. 1
 TBI 11-2702-21
 21.5 cm/8 1/2"



Fig. 2
 TBI 11-2703-21
 21 cm/8 1/4"



Fig. 3
 TBI 11-2704-20
 20.5 cm/8 1/8"

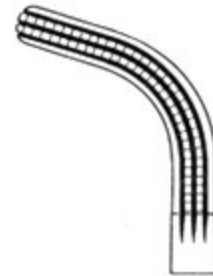

Fig. 4
 TBI 11-2705-20
 20 cm/7 7/8"

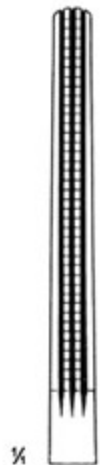

Fig. 1
 TBI 11-2706-25
 25.5 cm/10"

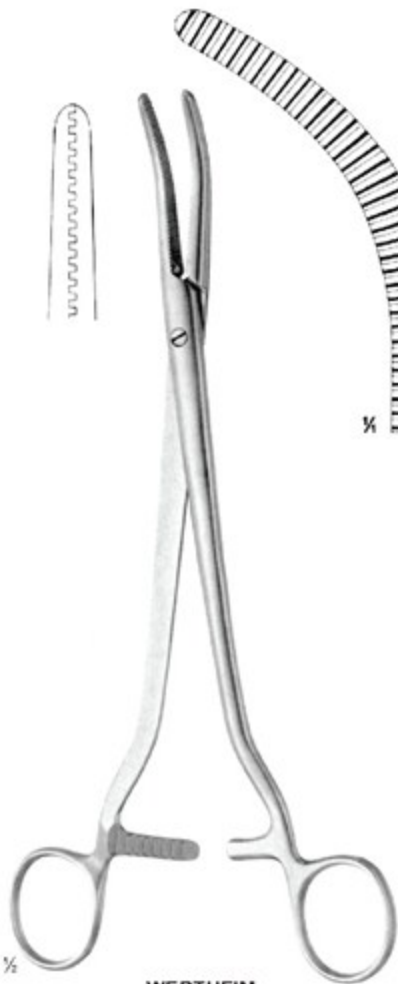

Fig. 2
 TBI 11-2707-25
 25 cm/9 7/8"

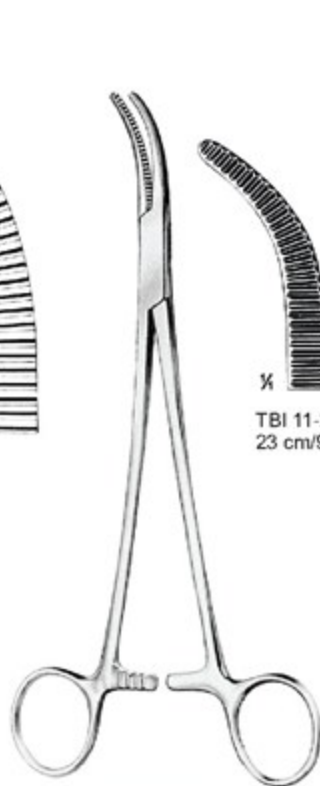

Fig. 3
 TBI 11-2708-24
 24.5 cm/9 3/4"





WERTHEIM
TBI 11-2709-25
25 cm/9 7/8"



MOYNIHAN



TBI 11-2710-23
23 cm/9"



TBI 11-2710-24
24 cm/9 1/2"



Heaney-Ballentine
21 cm/8 1/4"

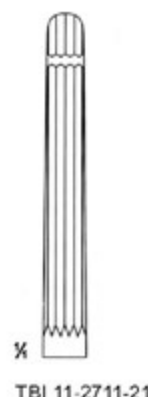

TBI 11-2711-21



TBI 11-2712-21

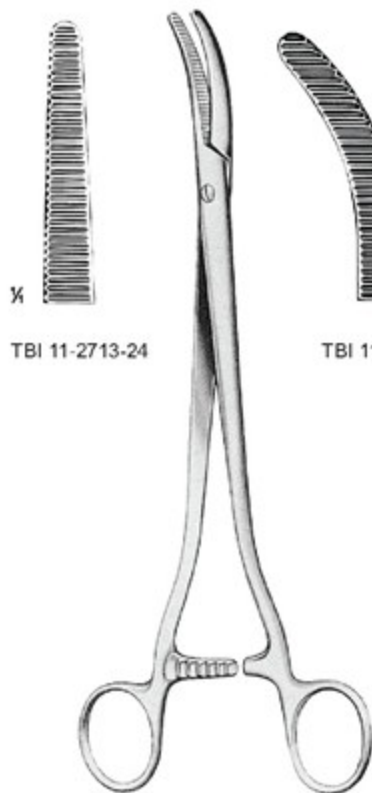

SEGOND-LANDAU
24 cm/9 1/2"



TBI 11-2713-24



TBI 11-2714-24

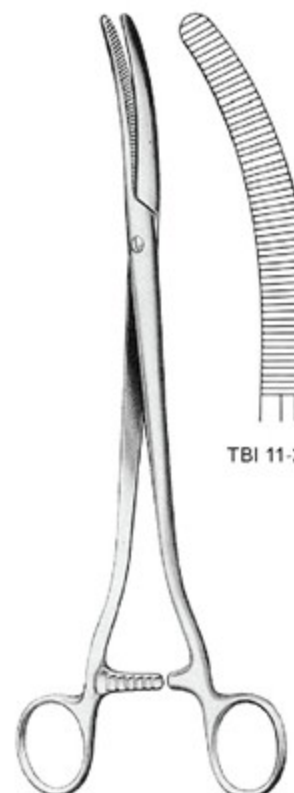

FAURE
25 cm/9 7/8"



TBI 11-2715-25

ARTERY FORCEPS

Heavy pattern

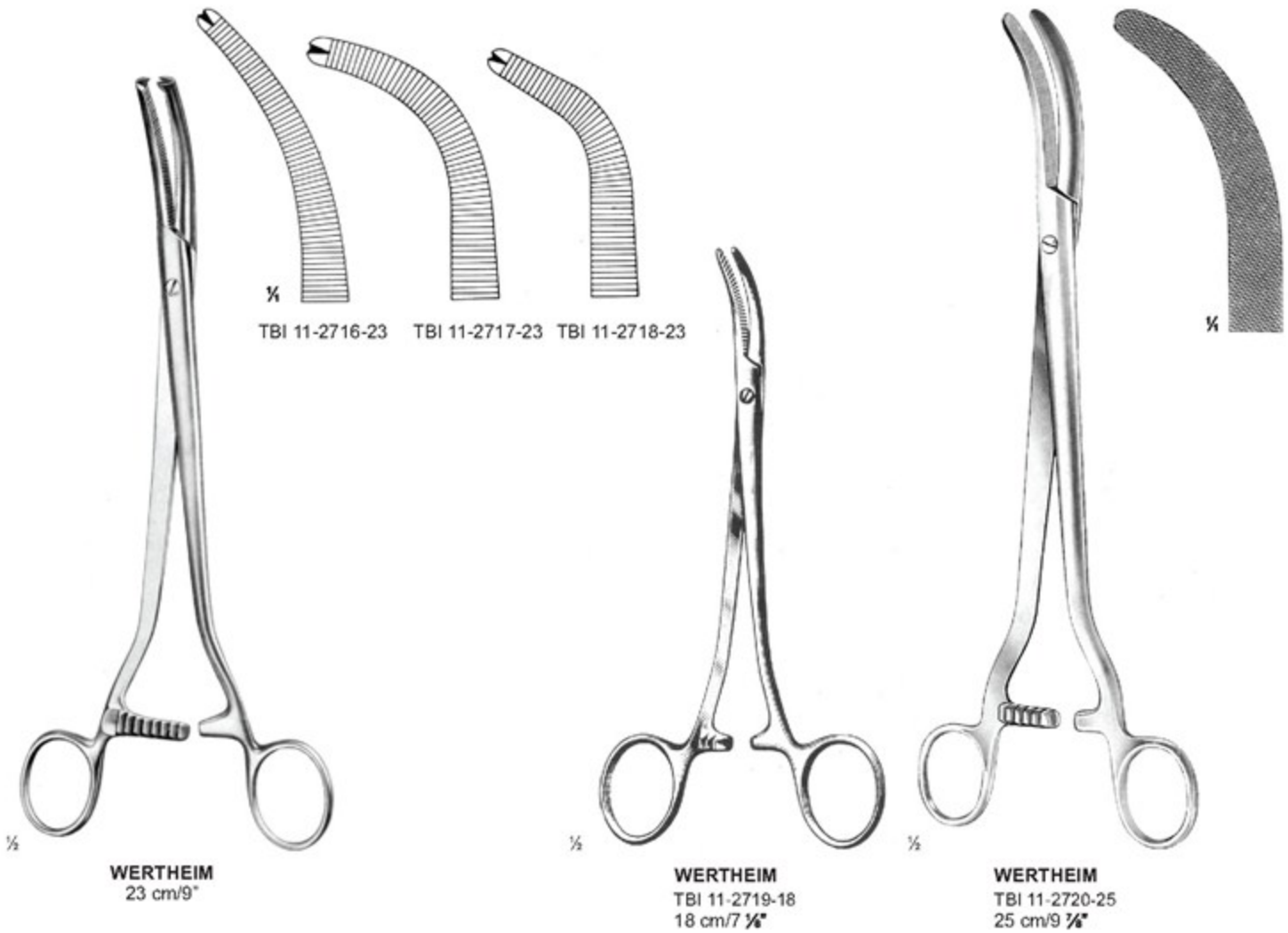

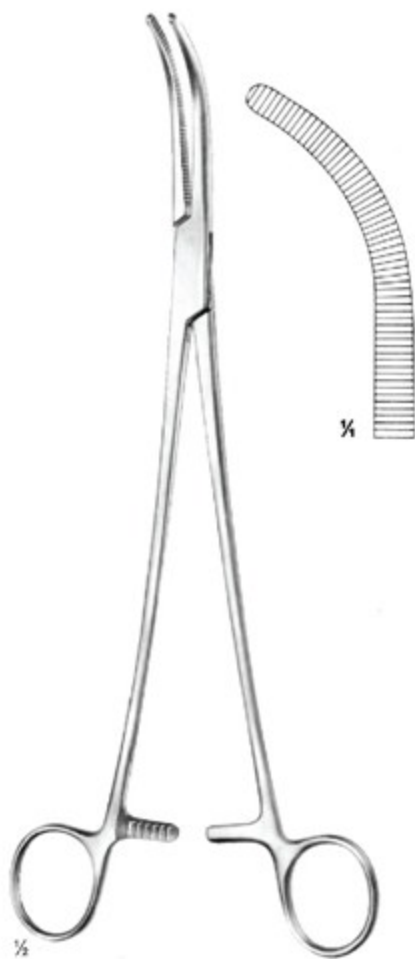

WERTHEIM
TBI 11-2721-25
25 cm/9 7/8"

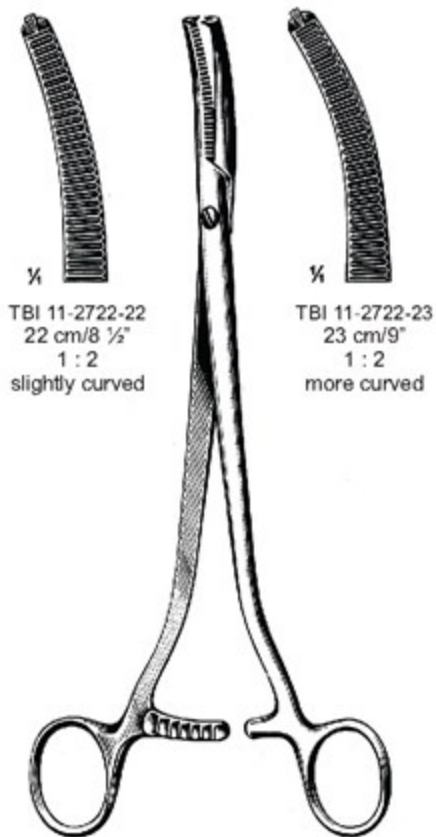

1/4
TBI 11-2722-22
22 cm/8 1/2"
1 : 2
slightly curved

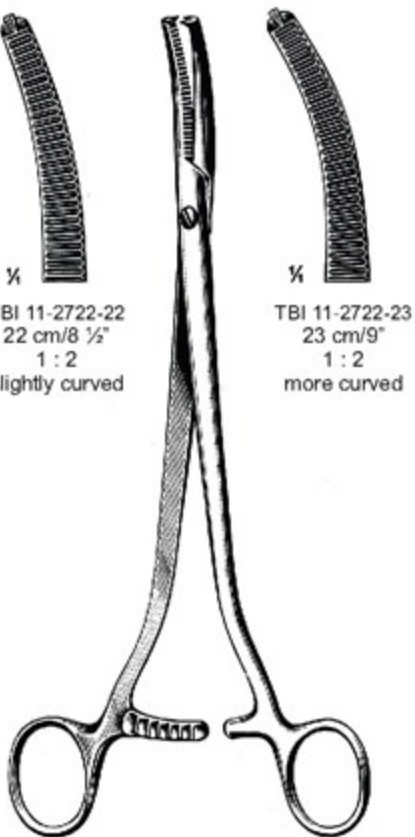

1/4
TBI 11-2722-23
23 cm/9"
1 : 2
more curved

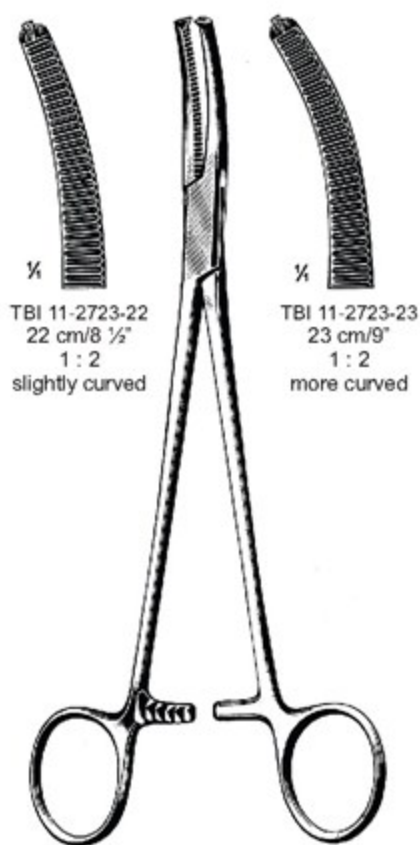

1/4
TBI 11-2723-22
22 cm/8 1/2"
1 : 2
slightly curved

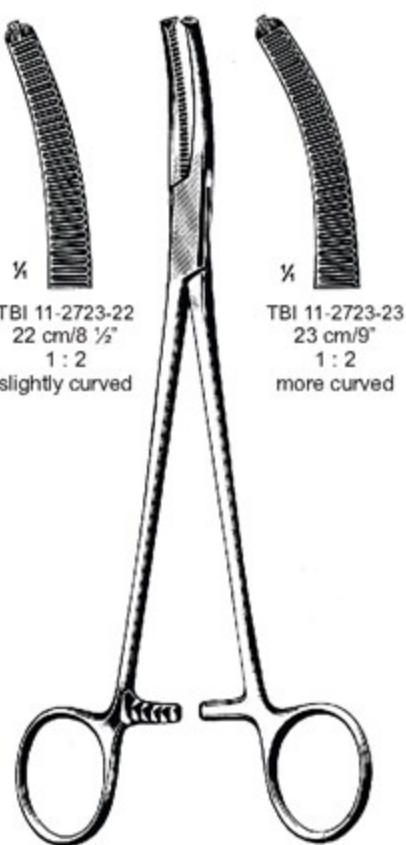

1/4
TBI 11-2723-23
23 cm/9"
1 : 2
more curved

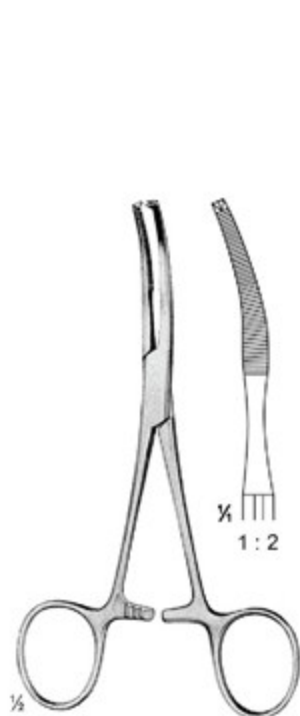

BABY-MIKULICZ
 TBI 11-2724-14
 14 cm/5 1/2"

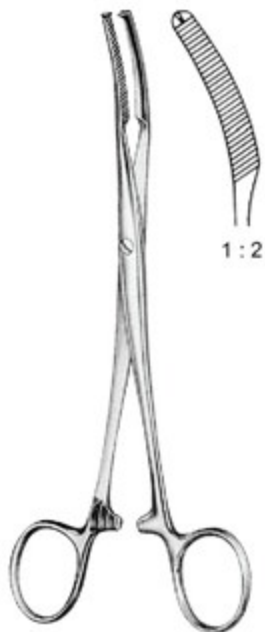

MIKULICZ
 TBI 11-2725-18 18 cm/7 1/8"
 TBI 11-2725-20 20 cm/7 7/8"

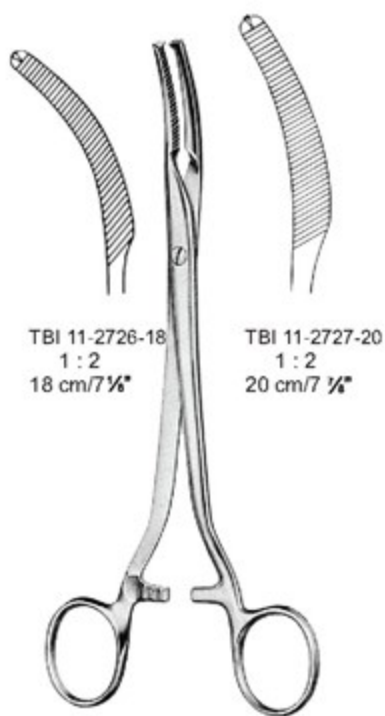

TBI 11-2726-18
 1:2
 18 cm/7 1/8"

TBI 11-2727-20
 1:2
 20 cm/7 7/8"

MIKULICZ

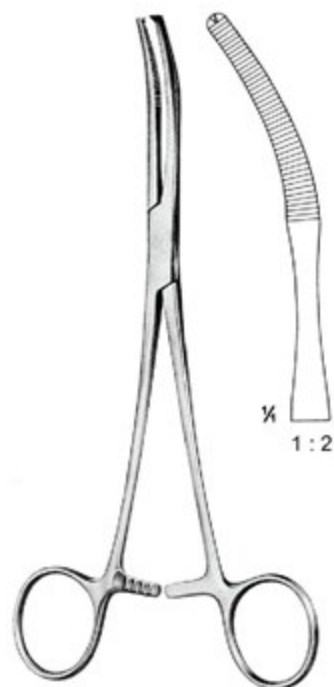

MIKULICZ
 TBI 11-2728-20 20 cm/7 7/8"

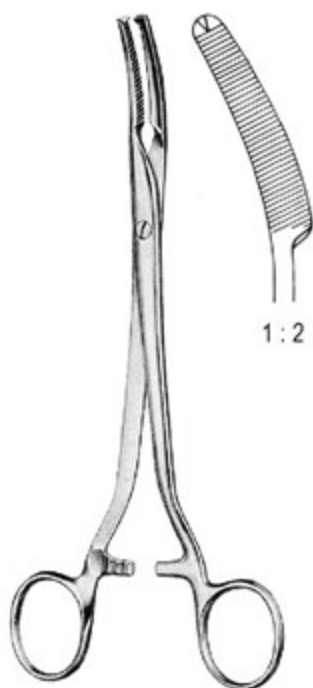

MIKULICZ
 TBI 11-2729-20
 20.5 cm/8 1/8"

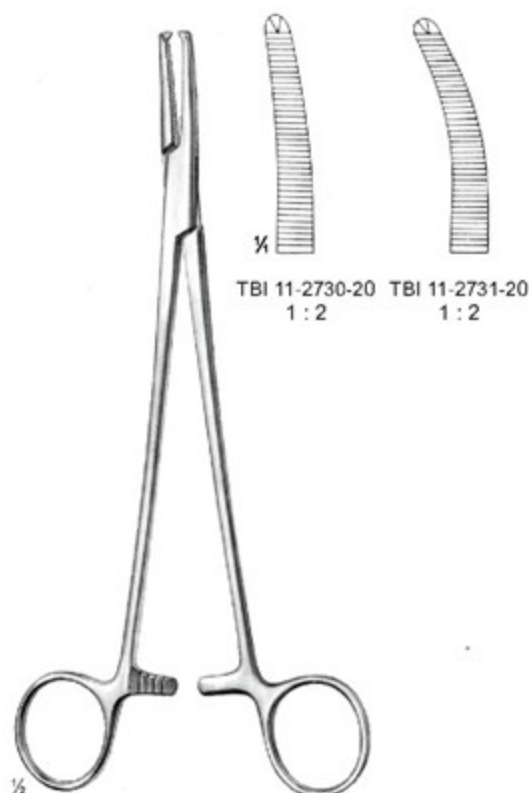

FAURE
 20 cm/7 7/8"





¼

MIKULICZ
 TBI 11-2732-18
 18 cm/7 ¼"

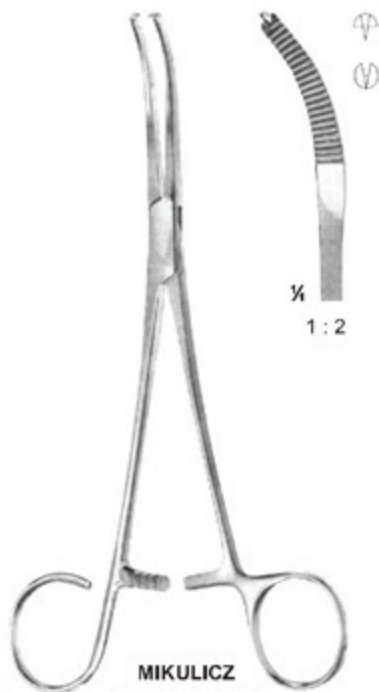

MIKULICZ
 TBI 11-2735-18
 18.5 cm/7 ½"

¼

MIKULICZ
 TBI 11-2733-20
 20 cm/7 ⅞"

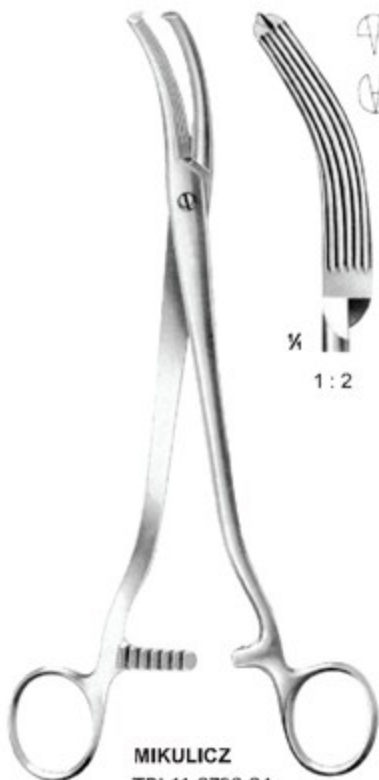

MIKULICZ
 TBI 11-2736-24
 24.5 cm/9 ⅞"

¼

MIKULICZ
 TBI 11-2734-20
 20.5 cm/8 ⅛"

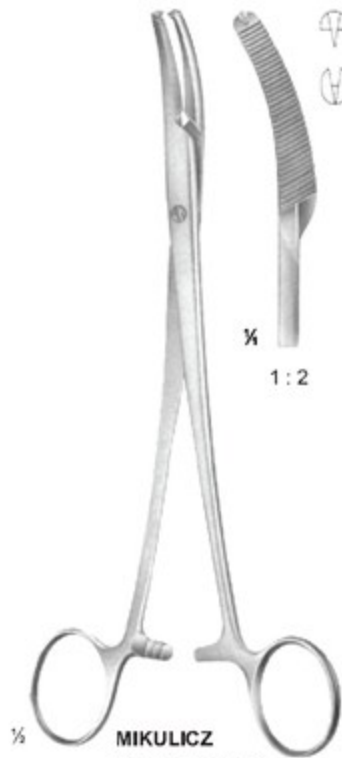

MIKULICZ
 TBI 11-2737-20
 20 cm/7 ⅞"

¼

1:2

¼

¼



SCHAEDEL
 TBI 11-2738-09
 9 cm/3 1/2"



ENGL. MODELL
 TBI 11-2739-09
 9 cm/3 1/2"



JONES
 TBI 11-2740-05 5 cm/2"
 TBI 11-2740-09 9 cm/3 1/2"



JONES
 TBI 11-2741-09
 9 cm/3 1/2"



DOYEN
 TBI 11-2742-11
 11 cm/4 3/8"



DOYEN
 TBI 11-2743-18
 18 cm/7 1/8"

With Clip for Tubing or Cable



BACKHAUS
 TBI 11-2744-11 11 cm/4 3/8"
 TBI 11-2744-13 13 cm/5 1/8"
 Delicate pattern, sharp



BACKHAUS
 TBI 11-2745-11
 11 cm/4 3/8"
 With Clip for Tubing or Cable

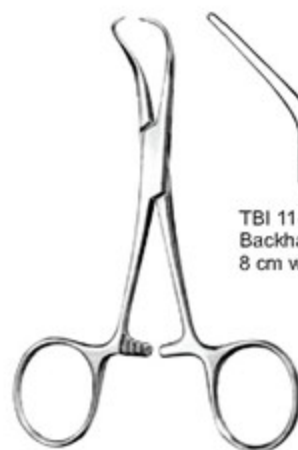

BACKHAUS
 TBI 11-2746-08 8 cm/3 1/8"
 TBI 11-2746-08 11 cm/4 3/8"
 TBI 11-2746-08 13 cm/5 1/8"
 TBI 11-2746-08 15 cm/5 7/8"

TBI 11-2747-08
 Backhaus Towel
 8 cm with open jaws



**BALL & SOCKET**

TBI 11-2748-11
 11.5 cm/4 1/2"

TBI 11-2748-14
 14 cm/5 1/2"

**TOHOKU**

TBI 11-2749-10
 10.5 cm/4 1/8"

TBI 11-2749-13
 13.5 cm/5 3/8"

**PEERS BERTRAM**

TBI 11-2750-14
 14.5 cm/5 3/4"

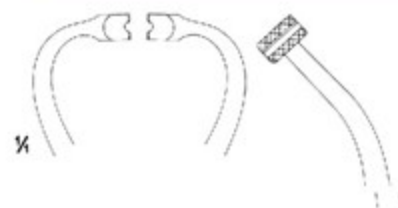
**PEERS-BERTRAM MODIF.**

TBI 11-2751-15
 15.5 cm/6 1/4"

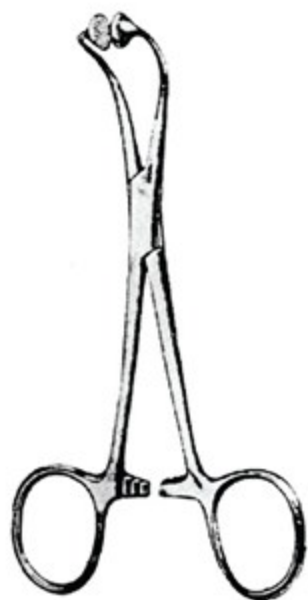
**HOFF**

TBI 11-2752-11 11 cm/4 3/8"
 TBI 11-2752-14 14.5 cm/5 3/4"

**ROBIN**

TBI 11-2753-13 13.5 cm/5 3/8"
 with holder for cable up to 5 mm

1/4

**ROBIN**

TBI 11-2754-13 13.5 cm/5 3/8"
 with holder for cable up to
 13 mm tubing

1/4

**PAPER TOWEL FORCEPS**

TBI 11-2755-10 10 cm/3 7/8"
 TBI 11-2755-13 13 cm/5 1/8"



ARTERY FORCEPS

Towel Forceps, Tubing Clamps — EN
 Tuchklemmen, Schlauchklemmen — DE
 Pinzas de campo, Pinzas para tubos — ES



ROEDER
 TBI 11-2756-13 13 cm/5 1/4"
 TBI 11-2756-15 15 cm/5 7/8"



LORNA
 TBI 11-2757-10 10 cm/3 7/8"
 TBI 11-2757-13 13 cm/5 1/4"



BERNHARD
 TBI 11-2758-16
 16.5 cm/6 1/2"



LANE
 TBI 11-2759-20
 20 cm/7 7/8"

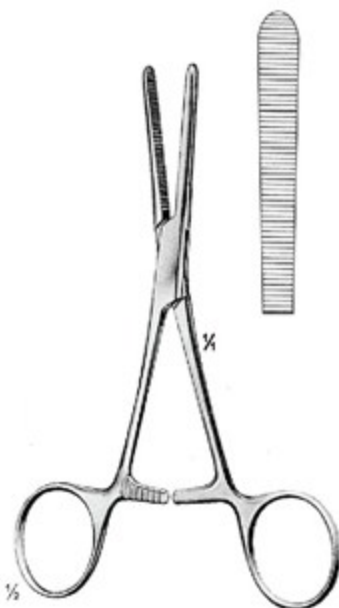

TBI 11-2760-14
 14.5 cm/5 3/4"
 with extra long ratchet

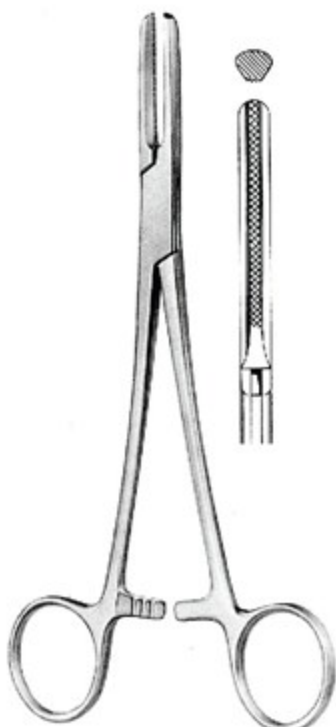

SCHOENBERG
 TBI 11-2761-15 15.5 cm/6 1/4"
 TBI 11-2761-19 19 cm/7 1/2"
 TBI 11-2761-20 20 cm/7 7/8"



SCHOENBERG
 TBI 11-2762-15 15.5 cm/6 1/4"
 TBI 11-2762-19 19 cm/7 1/2"
 TBI 11-2762-20 20 cm/7 7/8"
 with safety guard



PRESBYTERIAN-HOSPITAL
 TBI 11-2763-15 15.5 cm/6 1/4"
 TBI 11-2763-19 19 cm/7 1/2"
 TBI 11-2763-20 20 cm/7 7/8"





LISTER
 TBI 11-2764-20
 20 cm/7 7/8"



TBI 11-2764-13
 13 cm/5 1/8"



TBI 11-2764-15
 15 cm/5 7/8"



TBI 11-2764-18
 18 cm/7 1/8"

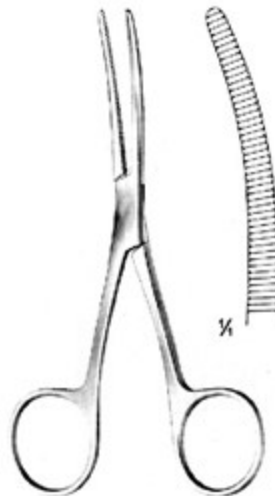

BRYANT
 TBI 11-2765-13
 13 cm/5 1/8"



- EN** Cotton Swab Forceps
- DE** Tupfer-und Kornzangen
- ES** Pinzas para tapones y curaciones

Page 158 to 163

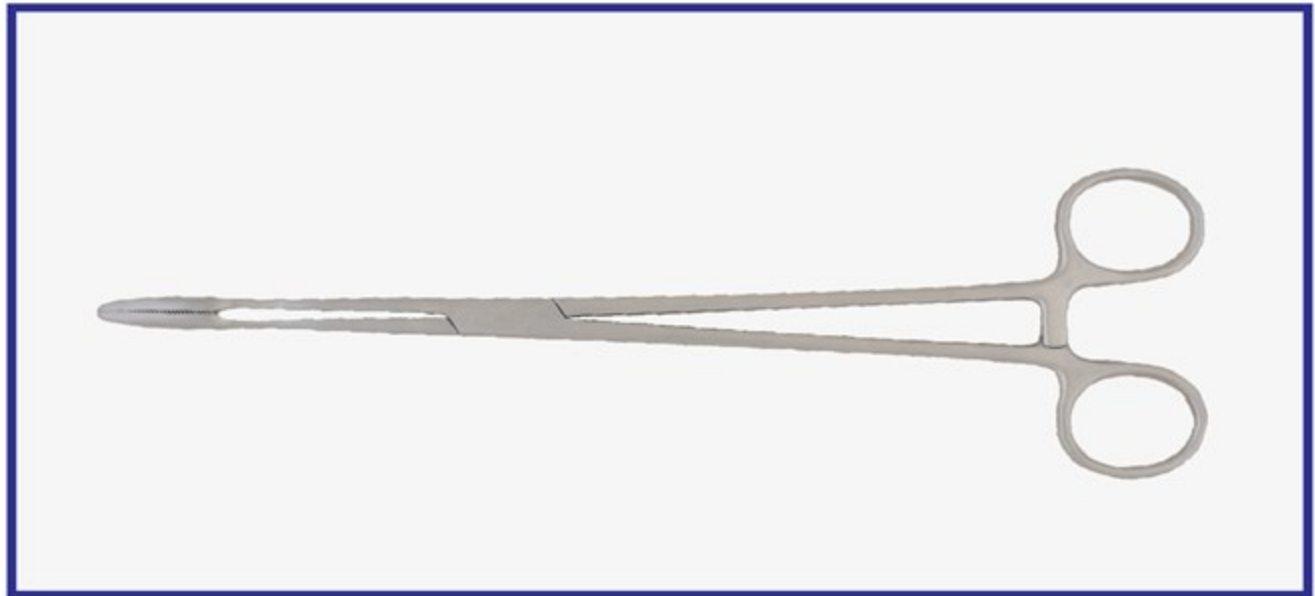

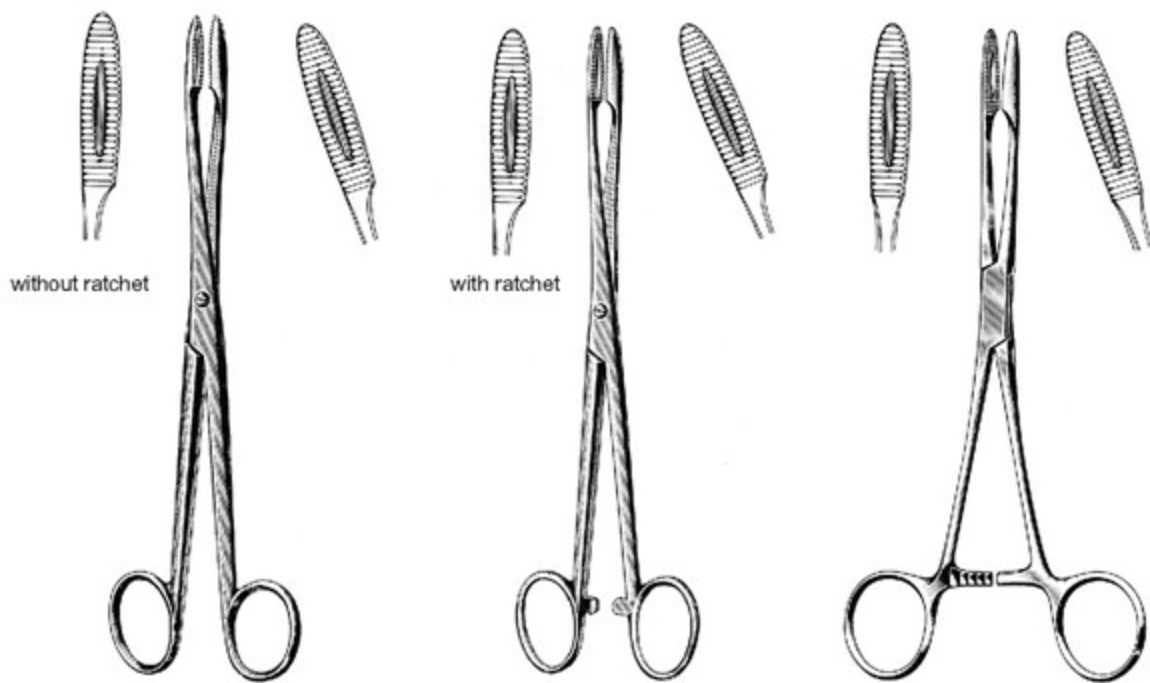

GROSS-MAIER				GROSS-MAIER				GROSS-MAIER			
straight		curved		cm	in	straight	curved	straight		curved	
TBI-2801-16	TBI-2802-16	14.5	5 3/4"	TBI-2803-14	TBI-2804-14	TBI-2805-20	20 cm/7 7/8"	TBI-2806-20			
TBI-2801-18	TBI-2802-18	16	6 1/4"	TBI-2803-16	TBI-2804-16	TBI-2805-22	22 cm/8 1/2"	TBI-2806-22			
TBI-2801-20	TBI-2802-20	18	7 1/8"	TBI-2803-18	TBI-2804-18	TBI-2805-25	25 cm/9 7/8"	TBI-2806-25			
TBI-2801-25	TBI-2802-25	20	7 7/8"	TBI-2803-20	TBI-2804-20						
		25	9 7/8"	TBI-2803-25	TBI-2804-25						



ULRICH

¼

TBI-2807-22
 22.5 cm/8 ¾"



TBI-2807-26
 26.5 cm/10 ½"



TBI-2808-22
 22.5 cm/8 ¾"



TBI-2808-26
 26.5 cm/10 ½"

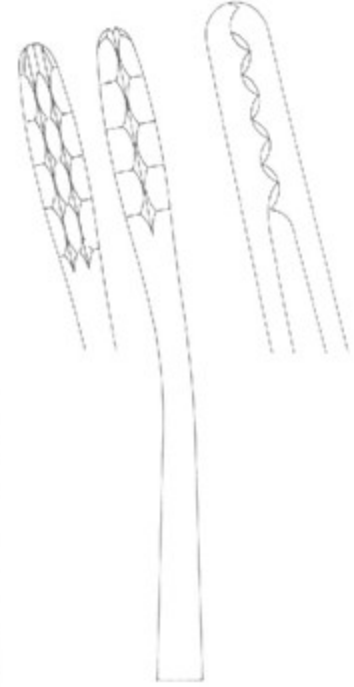

EMMET

TBI-2809-21
 21 cm/8 ¼"

¼

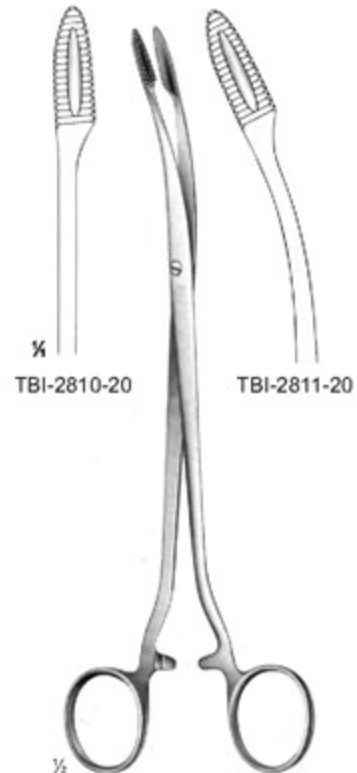

DUPLAY
 20 cm/7 ¾"

¼

TBI-2810-20

TBI-2811-20



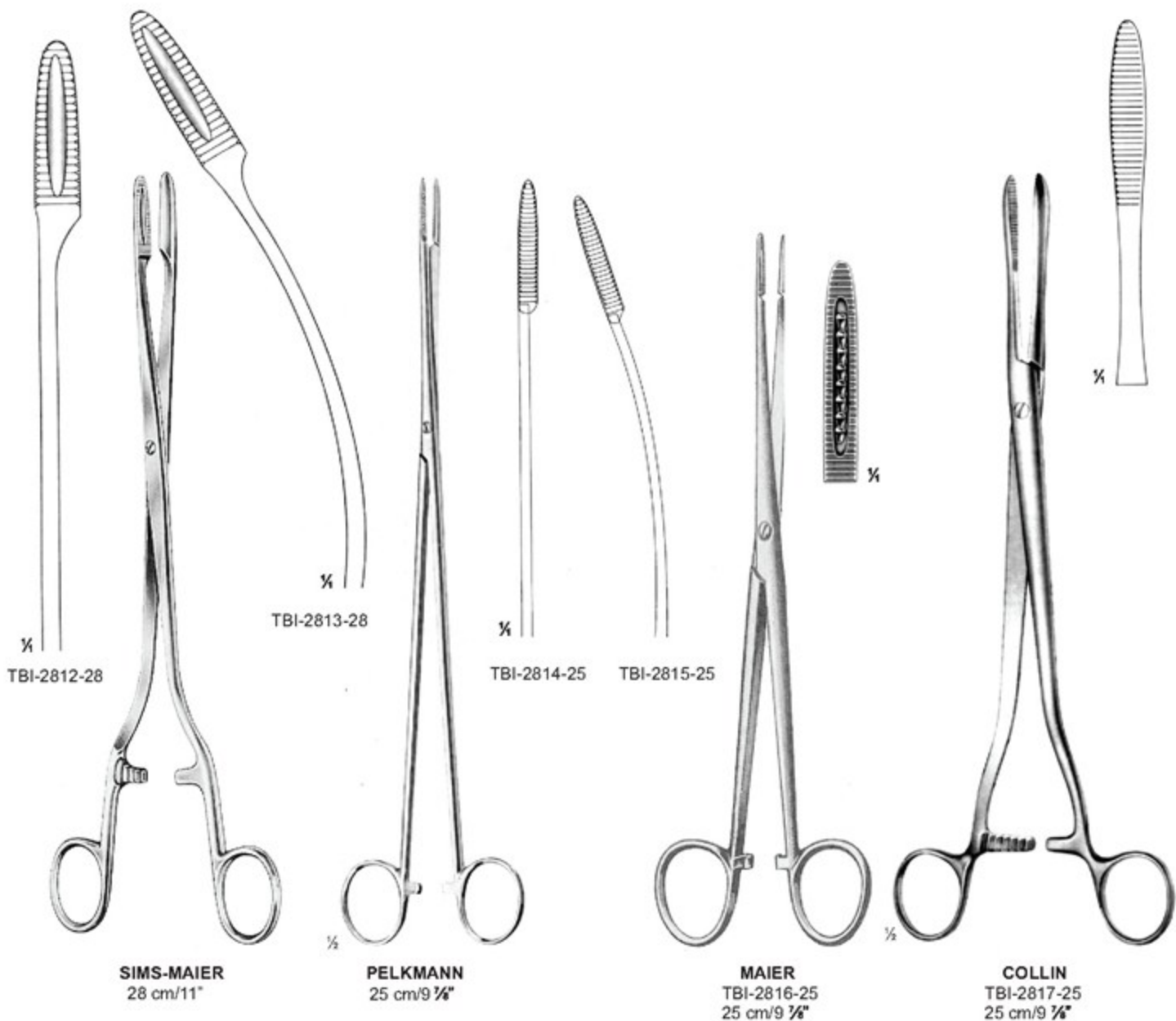

TBI-2812-28

SIMS-MAIER
28 cm/11"

TBI-2813-28

PELKMANN
25 cm/9 3/4"

TBI-2814-25

TBI-2815-25

MAIER
TBI-2816-25
25 cm/9 3/4"

COLLIN
TBI-2817-25
25 cm/9 3/4"

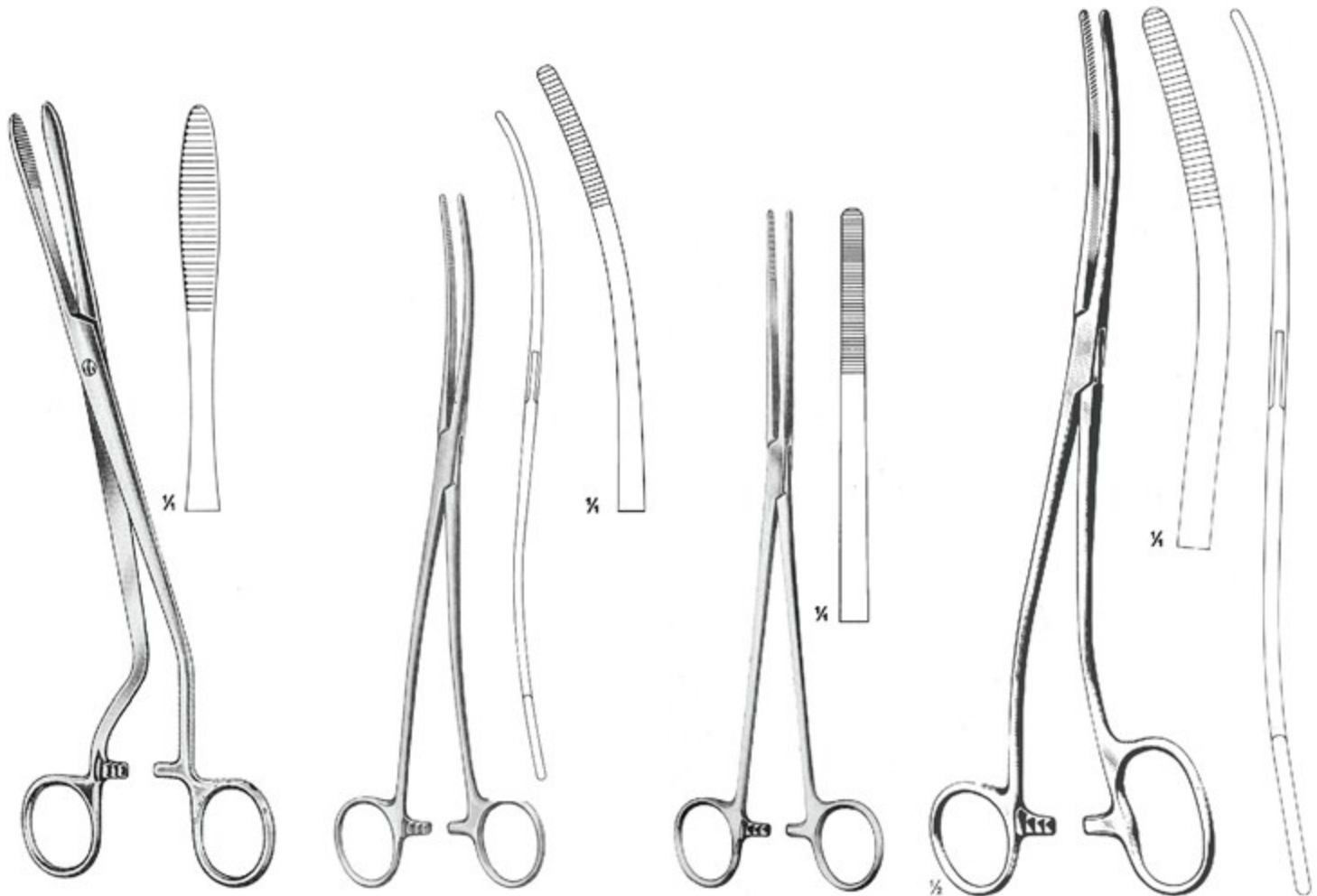

CHERON
 TBI-2818-25
 25 cm/9 7/8"

BOZEMANN
 TBI-2819-26
 26 cm/10 1/4"
 S-shaped

BOZEMANN
 TBI-2820-26
 26 cm/10 1/4"

BOZEMANN DOUGLAS
 TBI-2821-26
 26 cm/10 1/4"





FOERSTER

18 cm/7 1/8" TBI-2822-18
 20 cm/7 7/8" TBI-2822-20
 25 cm/9 7/8" TBI-2822-25



TBI-2823-18
 TBI-2823-20
 TBI-2823-25



TBI-2824-18
 TBI-2824-20
 TBI-2824-25



TBI-2825-18
 TBI-2825-20
 TBI-2825-25

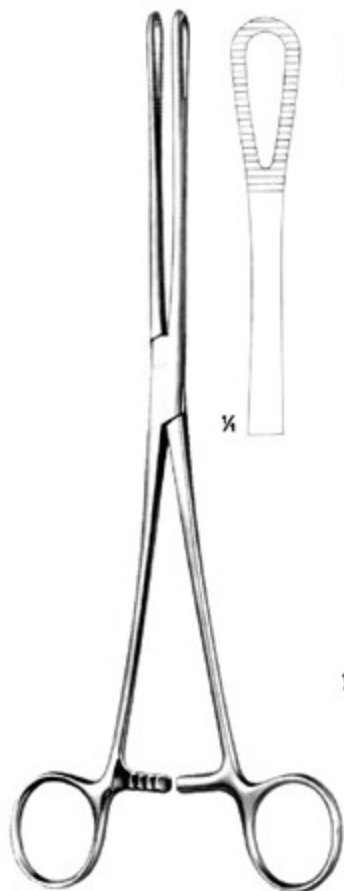

RAMPLEY
 TBI-2826-18 18.5 cm/7 1/4"
 TBI-2826-24 24.5 cm/9 5/8"

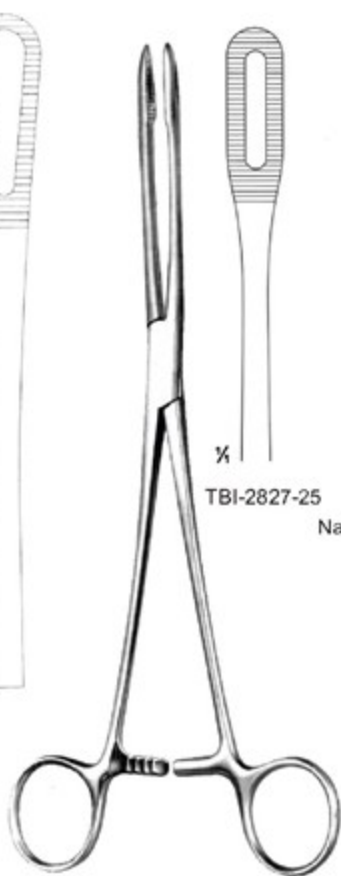

FOERSTER
 25 cm/9 7/8"



TBI-2827-25 TBI-2828-25
 Narrow



TBI-2829-25

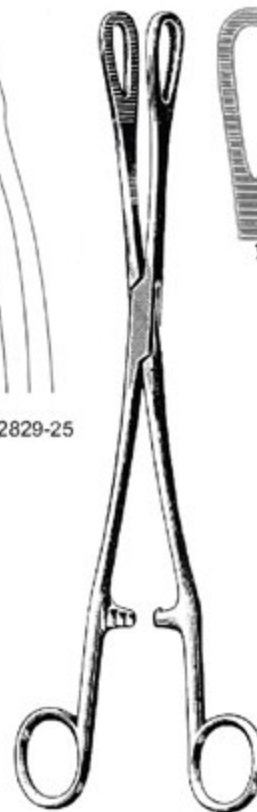

RAMPLEY
 TBI-2830-25
 25 cm/9 7/8"



BERGMANN-FOERSTER
 TBI-2831-24
 24 cm/9 1/2"

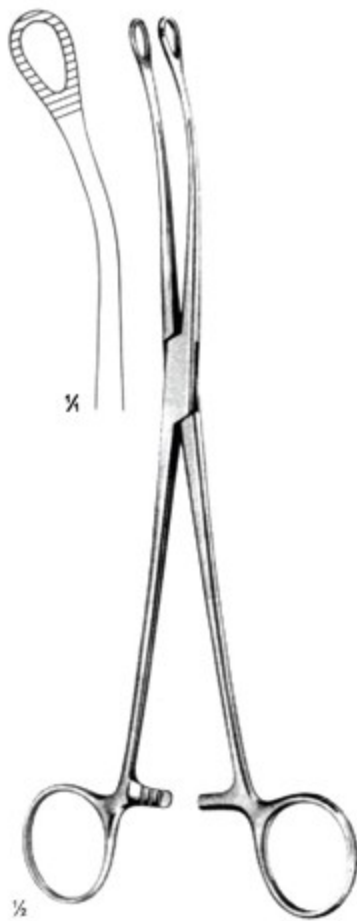

BERGMANN-FOERSTER
 TBI-2832-24
 24 cm/9 1/2"

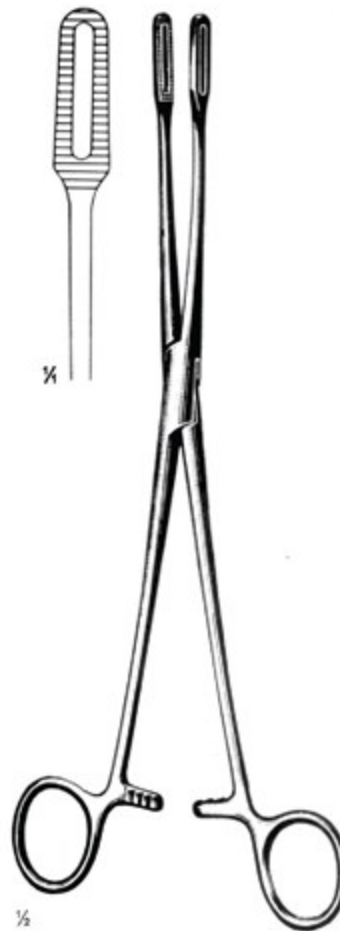

FLETCHER (JAVERTS)
 TBI-2833-24
 24 cm/9 1/2"

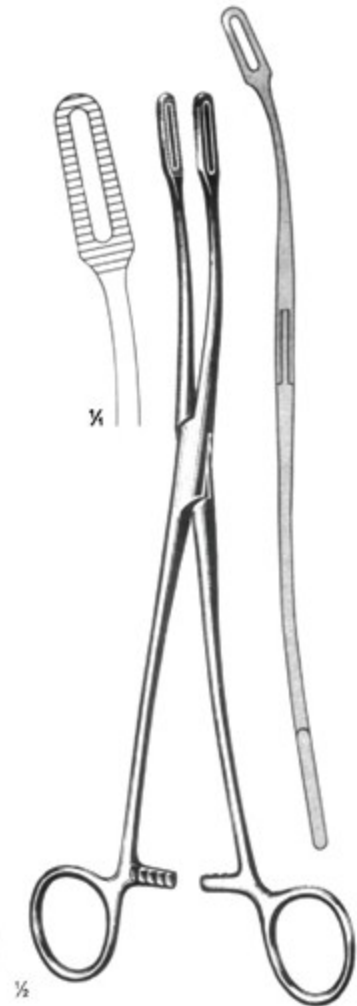

FLETCHER (JAVERTS)
 TBI-2834-24
 24 cm/9 1/2"













- EN** Probes, Applicators, Spatulas
- DE** Sonden, Watteträger, Spatel
- ES** Sondas, Porta-algodones, Espátulas

Page 164 to 169





					
	1mm	2mm			
11.5cm	TBI 13-2901-11	TBI 13-2902-11	TBI 13-2903-11		
12.5cm	TBI 13-2901-12	TBI 13-2902-12	TBI 13-2903-12	TBI 13-2904-12	TBI 13-2905-12
14.0cm	TBI 13-2901-14	TBI 13-2902-14	TBI 13-2903-14	TBI 13-2904-14	TBI 13-2905-14
16.0cm	TBI 13-2901-16	TBI 13-2902-16	TBI 13-2903-16	TBI 13-2904-16	TBI 13-2905-16
18.0cm	TBI 13-2901-18	TBI 13-2902-18	TBI 13-2903-18	TBI 13-2904-18	TBI 13-2905-18
20.0cm	TBI 13-2901-20	TBI 13-2902-20	TBI 13-2903-20	TBI 13-2904-20	TBI 13-2905-20
25.0cm	TBI 13-2901-25	TBI 13-2902-25	TBI 13-2903-25		

					
		Silver		FISH	FISH
10.5cm	TBI 13-2906-10	11.5cm TBI 13-2907-11	TBI 13-2908-11	TBI 13-2909-14	14.5cm TBI 13-2910-10
13.0cm	TBI 13-2906-13	12.5cm TBI 13-2907-12	TBI 13-2908-12	TBI 13-2909-18	18.0cm
14.5cm	TBI 13-2906-14	14.0cm TBI 13-2907-14	TBI 13-2908-14		
16.0cm	TBI 13-2906-16	16.0cm TBI 13-2907-16	TBI 13-2908-16		
18.0cm	TBI 13-2906-18	18.0cm TBI 13-2907-18	TBI 13-2908-18		
20.0cm	TBI 13-2906-20	20.0cm TBI 13-2907-20	TBI 13-2908-20		
		25.0cm TBI 13-2907-25	TBI 13-2908-25		



11.5cm TBI 13-2911-11
12.5cm TBI 13-2911-12
14.0cm TBI 13-2911-14
16.0cm TBI 13-2911-16
18.0cm TBI 13-2911-18
20.0cm TBI 13-2911-20



TBI 13-2912-11
TBI 13-2912-12
TBI 13-2912-14
TBI 13-2912-16
TBI 13-2912-18
TBI 13-2912-20



DOYEN
TBI 13-2913-14
14.0cm



NELATON
TBI 13-2914-16
16.0cm



TBI 13-2915-12
12.0cm



KRONECKER
TBI 13-2916-16
13.0 cm



JOHNS-HOPKINS
TBI 13-2917-15
15.0 cm



ROSER
TBI 13-2918-12
12.5 cm



SYME
TBI 13-2919-17
17.0 cm



TBI 13-2920-17
17.0 cm





TBI 13-2921-13 13.0 cm
 TBI 13-2921-14 14.5 cm



TBI 13-2922-17
 17.5 cm



MCDONALD
 TBI 13-2923-19
 19.0 cm



KILLIAN
 TBI 13-2924-19
 19.0 cm



WATSON CHEYENE
 TBI 13-2925-13 13.0 cm
 TBI 13-2925-19 19.0 cm



WATSON CHEYENE
 TBI 13-2926-17
 17.5 cm



PLAYFAIR
 TBI 13-2927-31
 31.0 cm



CHEYENE
 TBI 13-2928-12 12.5 cm
 TBI 13-2928-17 17.5 cm

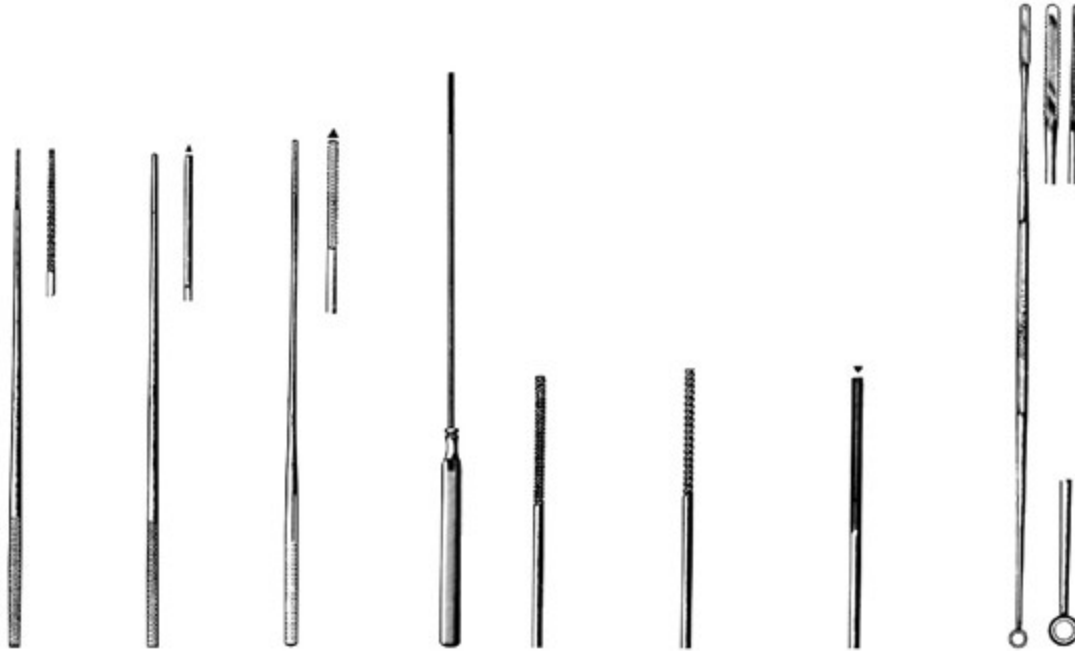

	FARREL	FARREL	FARREL
12.0cm	TBI 13-2929-12	TBI 13-2930-12	TBI 13-2931-12
14.0cm	TBI 13-2929-14	TBI 13-2930-14	TBI 13-2931-14
16.0cm	TBI 13-2929-16	TBI 13-2930-16	TBI 13-2931-16
18.0cm	TBI 13-2929-18	TBI 13-2930-18	TBI 13-2931-18
23.0cm	TBI 13-2929-23	TBI 13-2930-23	TBI 13-2931-23

TBI 13-2932-12
 TBI 13-2932-14
 TBI 13-2932-16
 TBI 13-2932-18

TBI 13-2933-12
 TBI 13-2933-14
 TBI 13-2933-16
 TBI 13-2933-18

TBI 13-2934-12
 TBI 13-2934-14
 TBI 13-2934-16
 TBI 13-2934-18

JOBSON-HORNE
 TBI 13-2935-12 12.5 cm
 TBI 13-2935-18 18.0 cm



JOBSON-HORNE
 TBI 13-2936-15
 15.0 cm

TBI 13-2937-16
 16.0 cm

TBI 13-2938-25
 25.0 cm

TBI 13-2939-28
 28.0 cm

TBI 13-2940-28
 28.0 cm

TBI 13-2941-28
 28.0 cm





HARTMANN
 TBI 13-2942-20
 20.0 cm



FEIN
 TBI 13-2943-28
 28.0 cm



TOBOLD
 TBI 13-2944-25
 25.0 cm



TBI 13-2945-40
 40.0 cm



TBI 13-2946-45
 45.0 cm

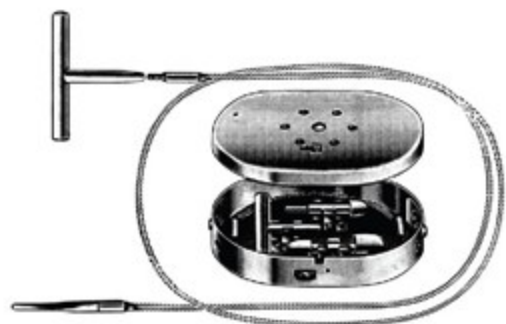

NABATOFF
 TBI 13-2947-00
 complete set.
 135 x 100 x 25mm

TBI 13-2948-01

TBI 13-2949-02

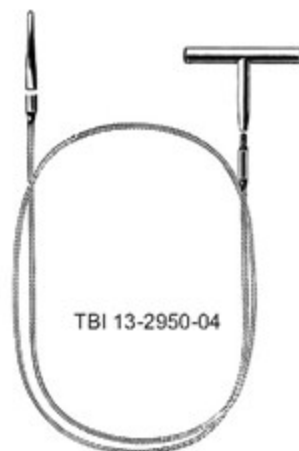

TBI 13-2950-04



TBI 13-2951-03
 3.0mm Ø



TBI 13-2951-06
 6.0mm Ø



TBI 13-2951-09
 9.0mm Ø



TBI 13-2951-12
 12.0mm Ø



TBI 13-2951-15
 15.0mm Ø



50.0 cm



TBI 13-2953-50
 2.0mm Ø



TBI 13-2954-50
 3.0mm Ø



TBI 13-2955-50
 4.0mm Ø



TBI 13-2956-50
 6.0mm Ø



TBI 13-2957-50
 7.0mm Ø



TBI 13-2958-50
 8.5mm Ø

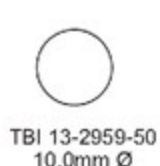

TBI 13-2959-50
 10.0mm Ø

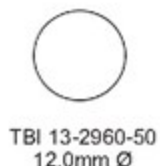

TBI 13-2960-50
 12.0mm Ø

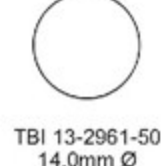

TBI 13-2961-50
 14.0mm Ø



TBI 13-2952-12
 12.0 cm



EN Bone Surgery

DE Knochenchirurgie

ES Cirugía ósea

Page 170 to 268





Mead
 TBI 14-3001-17 17 cm/6 1/2"
 26mm Ø, 320 g (11 1/4 oz)



Partsch
 TBI 14-3002-18 18 cm/7"
 22mm Ø, 200 g (7 oz)



TBI 14-3003-30
 30mm Ø, 510 g



TBI 14-3004-26 250 g
 TBI 14-3005-26 450 g
 26.5 cm/10 3/4"



TBI 14-3006-18 18.5 cm/7 1/2"
 25mm Ø 135 g



lead filled

TBI 14-3007-19 19 cm/7 3/4"
 22mm Ø 155 g



Hajek
 TBI 14-3008-22 22 cm/8 3/4"
 27mm Ø 130 g

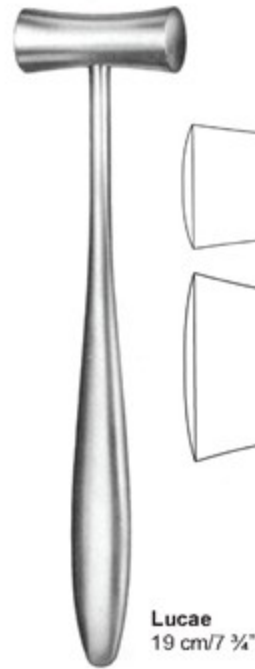
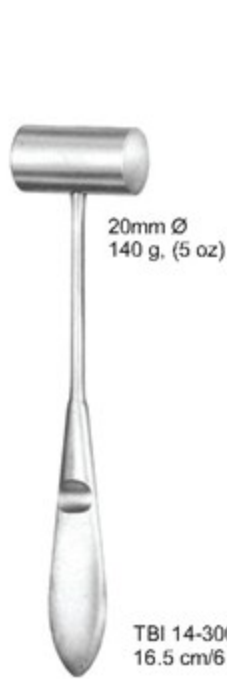



Gerzog
TBI 14-3014-18
18 cm/7"
250 g



Kirk
TBI 14-3015-19
19 cm/7 1/2"
750 g



Heath
18 cm/7"
TBI 14-3016-35 35mm Ø (28 oz)
TBI 14-3016-40 40mm Ø (36 oz)



TBI 14-3017-26
26.5 cm/10 1/2"
530 g (19 oz)



TBI 14-3018-24
24 cm/9 1/2"
(30mm Ø 480 g)



TBI 14-3019-22
22.5 cm/9"
(37mm Ø 370 g)

TBI 14-3020-00
Spare Faces



TBI 14-3020-24
24 cm/9 1/2"



TBI 14-3021-26 26.5 cm/10 1/2"
30mm Ø, 510 g (18 oz)



TBI 14-3022-26
26.5 cm/10 1/2"



TBI 14-3023-25 250 g (0.55 lbs)
TBI 14-3023-45 450 g (1 lbs)
TBI 14-3023-90 900 g (2 lbs)
26.5 cm/10 1/2"





Partsch
mm
02 TBI 14-3024-02
03 TBI 14-3024-03
04 TBI 14-3024-04
05 TBI 14-3024-05
06 TBI 14-3024-06
07 TBI 14-3024-07
08 TBI 14-3024-08
13.5 cm/5 1/4"



Partsch
TBI 14-3025-02
TBI 14-3025-03
TBI 14-3025-04
TBI 14-3025-05
TBI 14-3025-06
TBI 14-3025-07
TBI 14-3025-08
17 cm/6 3/4"
TBI 14-3026-02
TBI 14-3026-03
TBI 14-3026-04
TBI 14-3026-05
TBI 14-3026-06
TBI 14-3026-07
TBI 14-3026-08
13.5 cm/5 1/4"
TBI 14-3027-02
TBI 14-3027-03
TBI 14-3027-04
TBI 14-3027-05
TBI 14-3027-06
TBI 14-3027-07
TBI 14-3027-08
17 cm/6 3/4"



Width

mm
04 TBI 14-3028-04
06 TBI 14-3028-06
08 TBI 14-3028-08
10 TBI 14-3028-10
12 TBI 14-3028-12
14 TBI 14-3028-14
16 TBI 14-3028-16
TBI 14-3029-04
TBI 14-3029-06
TBI 14-3029-08
TBI 14-3029-10
TBI 14-3029-12
TBI 14-3029-14
TBI 14-3029-16
TBI 14-3030-04
TBI 14-3030-06
TBI 14-3030-08
TBI 14-3030-10
TBI 14-3030-12
TBI 14-3030-14
TBI 14-3030-16
13.5 cm/5 1/4"



mm
06 TBI 14-3031-06
12 TBI 14-3031-12
18 TBI 14-3031-18



Mod. USA
TBI 14-3032-06
TBI 14-3032-12
TBI 14-3032-18
16 cm/6 1/4"



TBI 14-3033-06
TBI 14-3033-12
TBI 14-3033-18



16 cm/6 1/4"

TBI 14-3034-03
3mm
TBI 14-3034-05
5mm
TBI 14-3034-07
7mm
2TBI 14-3034-09
9mm



Passow
12 cm/4 3/4"

TBI 14-3035-02
2.5mm
TBI 14-3035-03
3.5mm



Lexer
 27.5 cm/10³/₄"

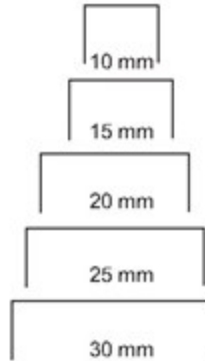

TBI 14-3036-10
 TBI 14-3036-15
 TBI 14-3036-20
 TBI 14-3036-25
 TBI 14-3036-30



TBI 14-3037-10
 TBI 14-3037-15
 TBI 14-3037-20
 TBI 14-3037-25
 TBI 14-3037-30



Cloward
 24 cm/9¹/₂"

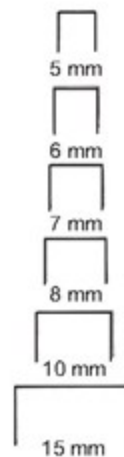

TBI 14-3038-05
 TBI 14-3038-06
 TBI 14-3038-07
 TBI 14-3038-08
 TBI 14-3038-10
 TBI 14-3038-15



TBI 14-3039-05
 TBI 14-3039-06
 TBI 14-3039-07
 TBI 14-3039-08
 TBI 14-3039-10
 TBI 14-3039-15





TBI 14-3040-10

BUCK-GRAMCKO
11 cm/4 1/2"



TBI 14-3041-10



TBI 14-3042-10

BUCK-GRAMCKO
10 cm/4"



TBI 14-3043-10



BUCKLEY
16 cm/6 1/2"



TBI 14-3044-02
2mm



TBI 14-3044-03
3mm



TBI 14-3044-04
4mm

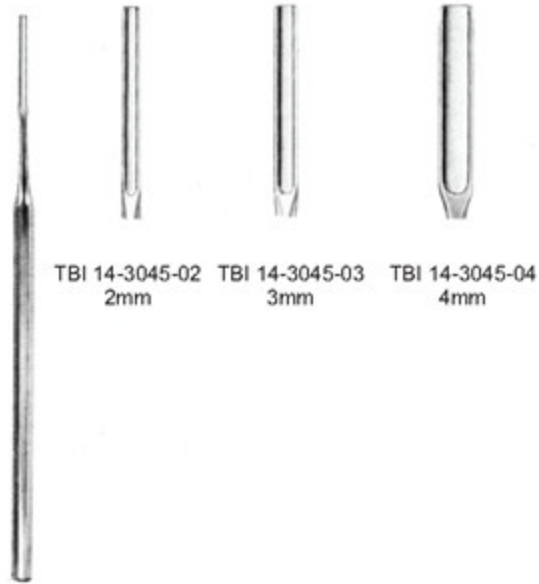

TBI 14-3045-02 2mm TBI 14-3045-03 3mm TBI 14-3045-04 4mm

BUCKLEY
16 cm/6 1/2"





Alexander
18 cm/7"

	mm	
TBI 14-3046-04	04	TBI 14-3047-04
TBI 14-3046-06	06	TBI 14-3047-06
TBI 14-3046-08	08	TBI 14-3047-08
TBI 14-3046-10	10	TBI 14-3047-10
TBI 14-3046-12	12	TBI 14-3047-12
TBI 14-3046-14	14	TBI 14-3047-14

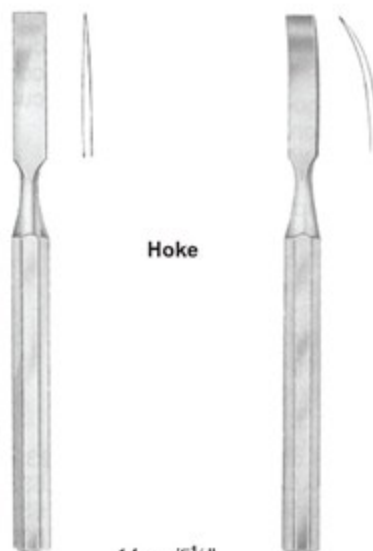

Hoke

14 cm/5½"

	mm	
TBI 14-3048-02	2	TBI 14-3049-02
TBI 14-3048-03	3	TBI 14-3049-03
TBI 14-3048-04	4	TBI 14-3049-04
TBI 14-3048-05	5	TBI 14-3049-05
TBI 14-3048-06	6	TBI 14-3049-06
TBI 14-3048-07	7	TBI 14-3049-07
TBI 14-3048-08	8	TBI 14-3049-08



Smith-Petersen
20 cm/8"



mm				
06	TBI 14-3050-06	TBI 14-3051-06	TBI 14-3052-06	TBI 14-3053-06
09	TBI 14-3050-09	TBI 14-3051-09	TBI 14-3052-09	TBI 14-3053-09
13	TBI 14-3050-13	TBI 14-3051-13		
14				
16	TBI 14-3050-16	TBI 14-3051-16	TBI 14-3052-14	TBI 14-3053-14
19	TBI 14-3050-19	TBI 14-3051-19	TBI 14-3052-16	TBI 14-3053-16
25	TBI 14-3050-25	TBI 14-3051-25	TBI 14-3052-19	TBI 14-3053-19
32	TBI 14-3050-32	TBI 14-3051-32	TBI 14-3052-25	TBI 14-3053-25
			TBI 14-3052-32	TBI 14-3053-32



Lambotte

mm		mm	
TBI 14-3054-04	04	TBI 14-3055-04	04
TBI 14-3054-06	06	TBI 14-3055-06	06
TBI 14-3054-08	08	TBI 14-3055-08	08
TBI 14-3054-10	10	TBI 14-3055-10	10
TBI 14-3054-13	13	TBI 14-3055-13	13
TBI 14-3054-16	16	TBI 14-3055-16	16
TBI 14-3054-18	18	TBI 14-3055-18	18
TBI 14-3054-20	20	TBI 14-3055-20	20
TBI 14-3054-25	25	TBI 14-3055-25	25
TBI 14-3054-30	30	TBI 14-3055-30	30
TBI 14-3054-38	38	TBI 14-3055-38	38
TBI 14-3054-44	44	TBI 14-3055-44	44
TBI 14-3054-50	50	TBI 14-3055-50	50

24 cm/9½" 23 cm/9"

Curved



Mini-Lambotte

mm		mm	
TBI 14-3056-02	02	TBI 14-3057-02	02
TBI 14-3056-03	03	TBI 14-3057-03	03
TBI 14-3056-04	04	TBI 14-3057-04	04
TBI 14-3056-06	06	TBI 14-3057-06	06
TBI 14-3056-08	08	TBI 14-3057-08	08
TBI 14-3056-10	10	TBI 14-3057-10	10
TBI 14-3056-12	12	TBI 14-3057-12	12
TBI 14-3056-15	15	TBI 14-3057-15	15

12.5 cm/5" 17 cm/6¾"



Mini-Lexer

mm		mm	
BI 14-3058-04	04	TBI 14-3059-04	04
BI 14-3058-06	06	TBI 14-3059-06	06
BI 14-3058-08	08	TBI 14-3059-08	08
BI 14-3058-10	10	TBI 14-3059-10	10
BI 14-3058-12	12	TBI 14-3059-12	12

18 cm/7"



Str	Lexer mm	Cvd
TBI 14-3060-05	05	TBI 14-3061-05
TBI 14-3060-07	07	TBI 14-3061-07
TBI 14-3060-10	10	TBI 14-3061-10
TBI 14-3060-15	15	TBI 14-3061-15
TBI 14-3060-20	20	TBI 14-3061-20
TBI 14-3060-25	25	TBI 14-3061-25
TBI 14-3060-30	30	TBI 14-3061-30

22 cm/8¾"



- Bone Chisels, Gauges
- Knochenmeißel, Hohlmeißel
- Cinceles, Gubias



Chisel
TBI 14-3062-20
24.5 cm/9 3/4"
20 mm



Chisel-Curved
TBI 14-3063-20
26.5 cm/10 1/2"
20 mm

Gouge for the
removing of
broken screws



TBI 14-3064-22
22 cm/8 3/4"



Zielke
 23 cm/9"
 5.5 mm TBI 14-3065-05
 9.0 mm TBI 14-3065-09



Width

mm	TBI 14-3066-06	TBI 14-3067-06	TBI 14-3068-06	TBI 14-3069-06	TBI 14-3070-06
06	TBI 14-3066-06	TBI 14-3067-06	TBI 14-3068-06	TBI 14-3069-06	TBI 14-3070-06
08	TBI 14-3066-08	TBI 14-3067-08	TBI 14-3068-08	TBI 14-3069-08	TBI 14-3070-08
10	TBI 14-3066-10	TBI 14-3067-10	TBI 14-3068-10	TBI 14-3069-10	TBI 14-3070-10
12	TBI 14-3066-12	TBI 14-3067-12	TBI 14-3068-12	TBI 14-3069-12	TBI 14-3070-12
15	TBI 14-3066-15	TBI 14-3067-15	TBI 14-3068-15	TBI 14-3069-15	TBI 14-3070-15
20	TBI 14-3066-20	TBI 14-3067-20	TBI 14-3068-20	TBI 14-3069-20	TBI 14-3070-20
25	TBI 14-3066-25	TBI 14-3067-25	TBI 14-3068-25	TBI 14-3069-25	TBI 14-3070-25
30	TBI 14-3066-30	TBI 14-3067-30	TBI 14-3068-30	TBI 14-3069-30	TBI 14-3070-30

Stille
 20 cm/8"



Hibbs
 24 cm/9 1/2"

mm	TBI 14-3071-06	TBI 14-3072-06	TBI 14-3073-06	TBI 14-3074-06	TBI 14-3075-06
06	TBI 14-3071-06	TBI 14-3072-06	TBI 14-3073-06	TBI 14-3074-06	TBI 14-3075-06
09	TBI 14-3071-09	TBI 14-3072-09	TBI 14-3073-09	TBI 14-3074-09	TBI 14-3075-09
13	TBI 14-3071-13	TBI 14-3072-13	TBI 14-3073-13	TBI 14-3074-13	TBI 14-3075-13
16	TBI 14-3071-16	TBI 14-3072-16	TBI 14-3073-16	TBI 14-3074-16	TBI 14-3075-16
19	TBI 14-3071-19	TBI 14-3072-19	TBI 14-3073-19	TBI 14-3074-19	TBI 14-3075-19
25	TBI 14-3071-25	TBI 14-3072-25	TBI 14-3073-25	TBI 14-3074-25	TBI 14-3075-25
32	TBI 14-3071-32	TBI 14-3072-32	TBI 14-3073-32	TBI 14-3074-32	TBI 14-3075-32



- Bone Chisels, Gauges
- Knochenmeißel, Hohlmeißel
- Cinceles, Gubias



mm **Lexer**
05 TBI 14-3076-05
10 TBI 14-3076-10
15 TBI 14-3076-15

28 cm/11"



Lexer
TBI 14-3077-05
TBI 14-3077-10
TBI 14-3077-15

25 cm/10"



Lexer
TBI 14-3078-05
TBI 14-3078-10
TBI 14-3078-15

25 cm/10"



TBI 14-3079-01



TBI 14-3079-02



TBI 14-3079-03



Cobb
28 cm/11" TBI 14-3079-04



Putti
TBI 14-3080-30
30 cm/12"



Putti
TBI 14-3081-27
27 cm/10½"



TBI 14-3082-28
28 cm/11"



TBI 14-3083-24
24 cm/9½"



TBI 14-3084-22
22 cm/8¾"



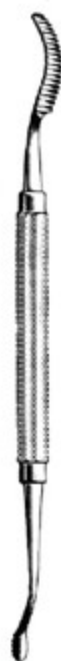

Miller
10
TBI 14-3085-10



Miller
11
TBI 14-3086-11



Miller
12
TBI 14-3087-12



Miller
13
TBI 14-3088-13



Miller
14
TBI 14-3089-14



Miller
10c
TBI 14-3090-10



Miller
11c
TBI 14-3091-11



Miller
12c
TBI 14-3092-12



Miller
13c
TBI 14-3093-13



Fomon
21.5cm
TBI 14-3094-21



Fomon
21.5cm
TBI 14-3095-21



CUSHING
17 cm/8 1/2"



TBI 14-3096-17 4mm
TBI 14-3097-17 6mm



CUSHING
19.5 cm/7 3/4"



TBI 14-3098-19 5mm
TBI 14-3099-19 7mm



HOEN



TBI 14-3100-16 7mm, 16 cm/6 1/2"
TBI 14-3100-18 15mm, 18.5 cm/7 1/2"
TBI 14-3100-19 20mm, 19 cm/7 3/4"



CUSHING
TBI 14-3101-17
17 cm/6 3/4"



8mm



LANGENBECK
TBI 14-3102-18
18 cm/7"



LANGENBECK
TBI 14-3103-19
19 cm/7 1/2"



16 cm/6 1/2"



TBI 14-3104-05
5mm



TBI 14-3104-06
6mm



TBI 14-3104-33
7mm





Lambotte
21 cm/8¼"

Width

mm
 TBI 14-3105-2105
 TBI 14-3106-2110
 TBI 14-3107-2115
 TBI 14-3108-2120
 TBI 14-3109-2125



Schneider
TBI 14-3110-17
13 mm
17.5 cm/7"



Schneider-Sauerbruch
TBI 14-3111-19
13 mm
19 cm/7½"

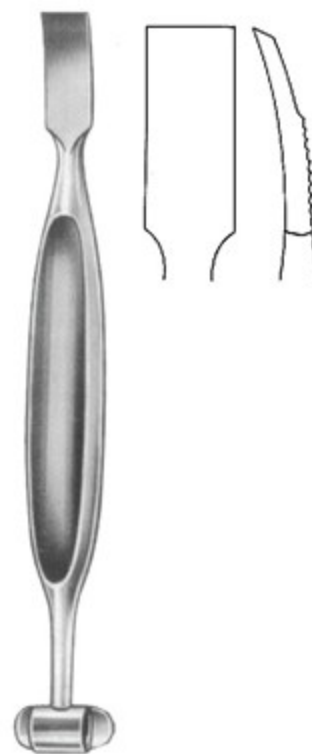

Alexander
TBI 14-3112-20
20 cm/8"



Jansen
TBI 14-3113-16
15 mm
16.5 cm/6½"



Seldin
TBI 14-3114-19
19 cm/7½"



Davidson-Alexander
TBI 14-3115-29
29 cm/11½"



Williger
TBI 14-3116-13
13 cm/5"

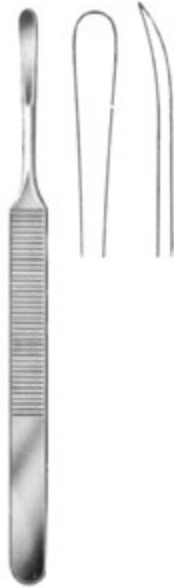

König
 TBI 14-3117-15
 15.5 cm/6"
 5 mm



Williger
 TBI 14-3118-16
 16 cm/6 1/4"



Adson
 17 cm/6 3/4"



TBI 14-3119-17



TBI 14-3120-17



TBI 14-3121-17



TBI 14-3122-17



TBI 14-3123-17 17 cm/6 3/4"
 6 mm TBI 14-3124-17
 8 mm





Farabeuf
TBI 14-3125-15
15 cm/6"



Farabeuf
TBI 14-3126-15
15 cm/6"



Farabeuf-Collin
TBI 14-3127-15
15.5 cm/6"
11 mm



Farabeuf-Collin
TBI 14-3128-15
15.5 cm/6"
11 mm



Farabeuf
TBI 14-3129-19
19 cm/7 1/2"
13 mm



Sedillot
TBI 14-3130-18
18 cm/7"
18 mm



Sedillot
TBI 14-31301-21
21 cm/8 1/4"
15 mm



LANGENBECK



TBI 14-3132-19
19.0cm, 16mm

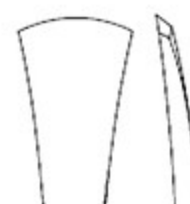

TBI 14-3133-19
19.0cm, 16cm



TBI 14-3134-19
19.0cm, 12mm



TBI 14-3135-18
18.0cm, 12mm



Overholt
 TBI 14-3136-29
 29.5 cm/11½"



Overholt
 TBI 14-3137-29
 29.5 cm/11½"



Overholt
 TBI 14-3138-28
 28.5 cm/11¼"



Hylin TBI 14-3141-14
 14.5 cm/5¾"



TBI 14-3139-14



TBI 14-3140-14



TBI 14-3141-14



Matson
 TBI 14-3142-22
 22 cm/8¾"





Semb

TBI 14-3143-19
19.5 cm/7 1/2"
12 mm



TBI 14-3144-19
19.5 cm/7 1/2"
12 mm



TBI 14-3145-19
19.5 cm/7 1/2"
12 mm



TBI 14-3146-22
22 cm/8 3/4"
13 mm



TBI 14-3147-21
21.5 cm/8 1/2"
13 mm



TBI 14-3148-22
22 cm/8 1/2"
15 mm



TBI 14-3149-22
22 cm/8 1/2"
15 mm



Doyen
17 cm/6 3/4"



TBI 14-3150-17



TBI 14-3151-17



TBI 14-3152-17



TBI 14-3153-17



Doyen
TBI 14-3154-24 24 cm/9 1/2" TBI 14-3155-24

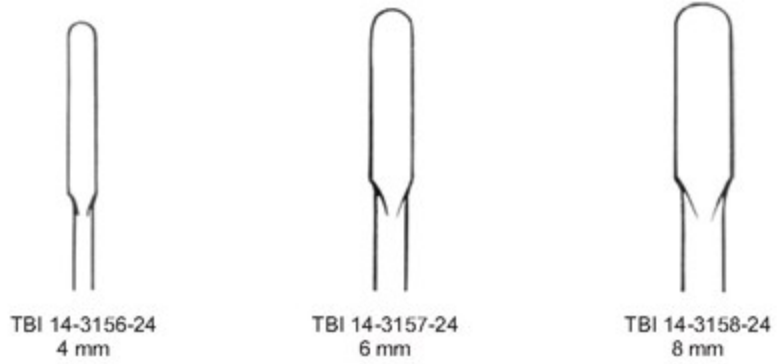

Cobb
24 cm/9½"

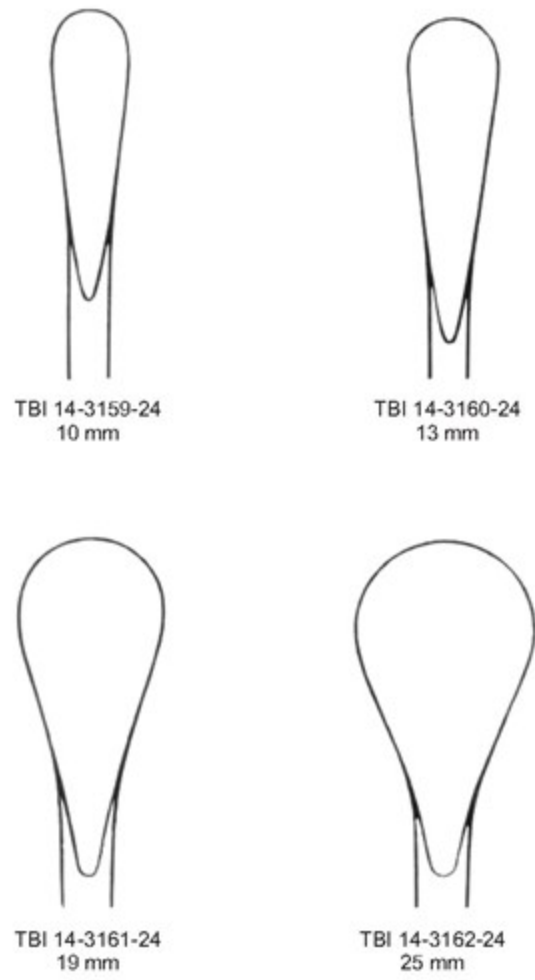



TBI 14-3163-19
19 cm/7½"
6 mm



TBI 14-31634-18
18.5 cm/7¼"
3 mm



TBI 14-3165-18
18.5 cm/7¼"
6 mm



TBI 14-3166-18
18.5 cm/7¼"
6 mm

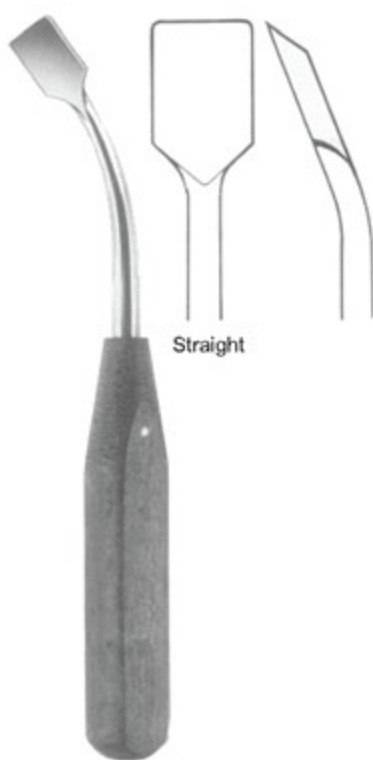

TBI 14-3167-18
18.5 cm/7¼"
13 mm



TBI 14-3168-19
19.5 cm/7¾"
14 mm



TBI 14-3169-18
18.5 cm/7¼"
14 mm



TBI 14-3170-20
20 cm/8"
20 mm



TBI 14-3171-27
 27.5 cm/10 3/4"
 20 mm



Wagner
 8 mm TBI 14-3172-33
 17 mm TBI 14-3173-33
 33 cm/13"



Cobb
 24 cm TBI 14-3174-24
 28 cm TBI 14-3179-28
 10 mm TBI 14-3175-24
 13 mm TBI 14-3180-28
 19 mm TBI 14-3176-24
 25 mm TBI 14-3181-28
 32 mm TBI 14-3177-24
 TBI 14-3182-28
 TBI 14-3178-24
 TBI 14-3183-28



Cobb
 08 mm TBI 14-3184-28
 10 mm TBI 14-3185-28
 12 mm TBI 14-3186-28
 28 cm/11"



Cobb
 27.0cm TBI 14-3187-27
 4mm TBI 14-3188-27
 6mm TBI 14-3189-27
 8mm





TBI 14-3190-16
16 cm/6 1/2"
7 mm

TBI 14-3190-18
18.5 cm/7 1/4"
15 mm

TBI 14-3190-19
19 cm/7 1/2"
20 mm

Hoen



Yankauer
TBI 14-3191-18
18 cm/7"



Langenbeck
TBI 14-3192-20
20 cm/8"
8 mm



Langenbeck
TBI 14-3193-20
20 cm/8"
10 mm



Langenbeck
TBI 14-3194-23
23 cm/9"
11 mm



Mass. Gen. Hosp.
TBI 14-3195-15
15 cm/6"



Quervain
TBI 14-3196-20
20 cm/8"



TBI 14-3197-16
16 cm/6 1/4"



Width	Key
6 mm	TBI 14-3198-19 19 cm/7 1/2"
12 mm	TBI 14-3199-19 19 cm/7 1/2"
19 mm	TBI 14-3200-19 19 cm/7 1/2"
25 mm	TBI 14-3201-19 19 cm/7 1/2"



Konig
TBI 14-3202-15
15 cm/6"
4.5 mm



Konig
TBI 14-3203-15
15 cm/6"
4.5 mm



Alderdyce
TBI 14-3204-21
21 cm/8 1/4"

McDonald
TBI 14-3205-19
19 cm/7 1/2"

Watson-Cheyne
TBI 14-3206-17
17.5 cm/7"



Sebileau
TBI 14-3207-17
17 cm/6 3/4"





LANGENBECK
20 cm/8"
TBI 14-3208-20 8mm
TBI 14-3209-20 10mm



LANGENBECK

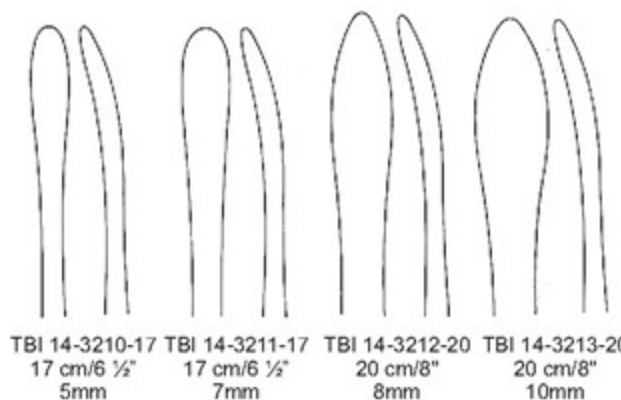

TBI 14-3210-17 17 cm/6 1/2" 5mm
TBI 14-3211-17 17 cm/6 1/2" 7mm
TBI 14-3212-20 20 cm/8" 8mm
TBI 14-3213-20 20 cm/8" 10mm



ST. THOMAS
TBI 14-3214-18
18 cm/7"



WILLIGER
17 cm/6 3/4"



TBI 14-3215-17



WILLIGER
16 cm/6 1/2"



TBI 14-3216-16



LANE
TBI 14-3217-26
26.5 cm/10 1/2"



LANE TRETOWAN
TBI 14-3218-21
21.5 cm/8 1/2"



LANE
TBI 14-3219-25
25.5 cm/10"



BRISTOW
TBI 14-3220-23
23 cm/9"



MURPHY-LANE
TBI 14-3221-34
34 cm/11 1/2"





TBI 14-3222-16
16 cm/6 1/2"



TBI 14-3223-14
14 cm/5 1/2"
2.8 mm



TBI 14-3224-14
14 cm/5 1/2"
5 mm



TBI 14-3225-14
14 cm/5 1/2"
7 mm



Buck-Gramcko
TBI 14-3226-15
15 cm/6"

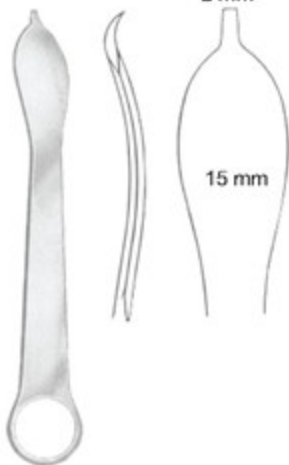

TBI 14-3227-12
12.5 cm/5"



Mini-Hohmann
TBI 14-3228-16
16 cm/6 1/4"



TBI 14-3228-16
6 mm



TBI 14-3229-16
8 mm



TBI 14-3230-16
16 cm/6 1/2"



TBI 14-3231-17
17.5 cm/7"



TBI 14-3232-26
 26.5 cm/10½"
 24 mm



Lange-Hohmann
 TBI 14-3233-26
 26 cm/10¼"
 22 mm



Hohmann
 TBI 14-3234-22
 22 cm/8¾"
 8 mm

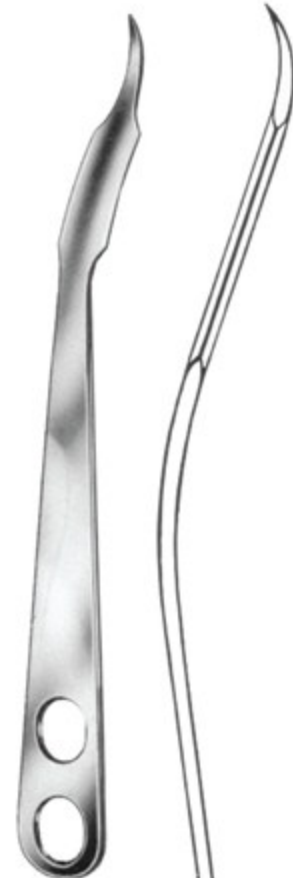

Hohmann
 TBI 14-3235-24
 24 cm/9½"
 14 mm



TBI 14-3236-17
 17 mm

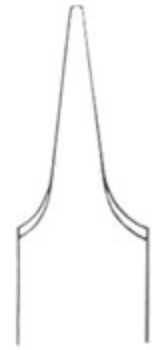

TBI 14-3237-17
 17 mm





Hohmann
TBI 14-3238-26
26 cm/10 1/4"
22 mm

Hohmann
TBI 14-3239-28
28 cm/11"
33 mm

Hohmann
TBI 14-3240-24
24 cm/9 1/2"
43 mm

Hohmann
TBI 14-3241-24
24.5 cm/9 3/4"
43 mm

Hohmann
TBI 14-3242-24
24 cm/9 1/2"
70 mm

Hohmann
TBI 14-3243-22
22 cm/8 3/4"
18 mm



Lange-Hohmann modif
 30 mm TBI 14-3244-26 26.5 cm/10½"
 33 mm TBI 14-3244-29 29.0 cm/11½"



Hohmann-Aldinger
 TBI 14-3245-27
 27 cm/10 ½"



Schumacher
 (Wagner)
 TBI 14-3246-34
 34.5 cm/13½"



Schumacher
 TBI 14-3247-29
 29 cm/11½"





TBI 14-3248-14
32 x19 mm
TBI 14-3249-14
48 x19 mm
TBI 14-3250-14
57 x19 mm

Smillie
14 cm/5½"



TBI 14-3251-14
52 x13 mm



TBI 14-3252-14
12 x13 mm

Spinal retractors



TBI 14-3253-17
75x30 mm
TBI 14-3254-17
100x30 mm

Taylor
17 cm/6½"



TBI 14-3255-21
21.5 cm/8½"

Meniscus retractors



Blount
TBI 14-3256-17
17.5 cm/7"



Murphy-Lane
 TBI 14-3257-32
 32 cm/12½"



Chandler

Length	Width
18 cm	13 mm
20 cm	19 mm
23 cm	25 mm
25 cm	30 mm

TBI 14-3258-18
 TBI 14-3258-20
 TBI 14-3258-23
 TBI 14-3258-25



Lange-Hohmann
 TBI 14-3259-27 27 cm/10 ½"
 TBI 14-3260-29 29 cm/11 ½"



Bennett
 TBI 14-3261-24 24 cm/8 ½"
 TBI 14-3262-26 26 cm/10 ½"



Blount
 TBI 14-3263-26
 26 cm/10¼"



Blount
 TBI 14-3264-26
 26 cm/10¼"



TBI 14-3265-24 44 mm
 TBI 14-3266-24 64 mm
Bennett
 24 cm/9½"



TBI 14-3267-17
 17 cm/6 ¾", 56x10mm
 Retractor





Smillie
TBI 14-3268-17
17 cm/6 3/4"



Smillie
TBI 14-3269-17
17 cm/6 3/4"



Smillie
TBI 14-3270-17
17 cm/6 3/4"



Salenius
TBI 14-3271-22
22 cm/8 3/4"



Salenius
TBI 14-3272-22
22 cm/8 3/4"



Mod. Schweden
17 cm/6 3/4"



left cutting
TBI 14-3273-17



right cutting
TBI 14-3274-17



Lowe-Breck
TBI 14-3275-25
25 cm/10"



Downing
TBI 14-3276-25
25 cm/10"



TBI 14-3277-17
17.5 cm/7"



Neff
21.5 cm/8 1/2"



TBI 14-3278-21
Left



TBI 14-3279-21
Right



Canad-Modell
TBI 14-3280-20 20 cm/8"



TBI 14-3281-20



BIRCHER
19 cm/7 3/4"



TBI 14-3282-19
TBI 14-3283-19



Stille
 20 cm/8"
 TBI 14-3284-20 compl. set
 TBI 14-3285-20 drill only



TBI 14-3286-20 2.5mm Ø TBI 14-3287-20 3.0mm Ø TBI 14-3288-20 3.5mm Ø TBI 14-3289-20 4.0mm Ø TBI 14-3290-20 10.0mm Ø TBI 14-3291-20 5.0mm Ø



TBI 14-3292-20 8.0mm Ø TBI 14-3293-20 12.0mm Ø TBI 14-3294-20 16.0mm Ø TBI 14-3295-20 1.0mm Ø TBI 14-3296-20 1.5mm Ø TBI 14-3297-20 2.0mm Ø





TBI 14-3298-00 compl. set
TBI 14-3299-00 drill only



TBI 14-3300-09 9.0cm 3.2mm Ø
TBI 14-3300-07 7.0cm 3.2mm Ø

TBI 14-3199-08
Set of drills



Jacobs
TBI 14-3301-06
6.35mm



TBI 14-3302-00 set



TBI 14-3303-00 set



Stille-Sherman
 24 cm/9 3/4"
 TBI 14-3304-24 compl. set
 TBI 14-3305-24 drill only



TBI 14-3306-24 2.5mm Ø
 TBI 14-3307-24 3.0mm Ø
 TBI 14-3308-24 3.5mm Ø



Hudson
 TBI 14-3309-00 compl. set / 6
 (TBI 14-3311-00,01,
 02,03,07,09)
 TBI 14-3310-00
 handle only



TBI 14-3312-09 9mm Ø
 TBI 14-3313-14 14mm Ø
 TBI 14-3314-16 16mm Ø
 TBI 14-3315-22 22mm Ø



Cushing TBI 14-3316-14 14mm Ø
Mckenzie TBI 14-3317-02 2mm Ø
Mckenzie TBI 14-3318-13 13mm Ø
Errico TBI 14-3319-16 16mm Ø
 TBI 14-3320-00





TBI 14-3321-00



TBI 14-3322-00



TBI 14-3323-00



TBI 14-3324-00 complete set



TBI 14-3325-00



Kirschner
TBI 14-3326-00 complete set



TBI 14-3328-00



TBI 14-3329-00



TBI 14-3327-00

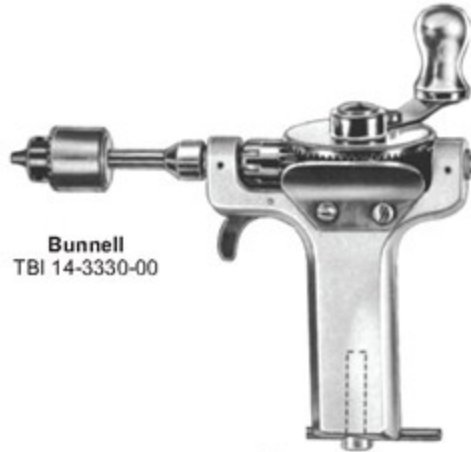

Bunnell
TBI 14-3330-00



Ralk
TBI 14-3331-00



Ralk-Universal
TBI 14-3332-00 Left hand
TBI 14-3333-00 Right hand



TBI 14-3334-00





Spare Saw Blade
 TBI 14-3335-12 12mm
 TBI 14-3335-15 15mm
 TBI 14-3335-18 18mm



Charriere
 TBI 14-3336-35
 35 cm/14"

Spare Saw Blade
 TBI 14-3337-03 3mm
 TBI 14-3337-05 5mm
 TBI 14-3337-07 7mm



Helferich-Bier
 TBI 14-3338-39
 39 cm/15 1/2"

Lindemann
 TBI 14-3339-20
 20 cm/8"



Langenbeck
 TBI 14-3340-23
 23 cm/9"



TBI 14-3341-06 6mm
 TBI 14-3341-08 8mm
 TBI 14-3341-12 12mm
 TBI 14-3341-15 15mm
 TBI 14-3341-18 18mm



Rust
 TBI 14-3342-39
 39 cm/15 1/2"





Charriere
 TBI 14-3343-27 27 cm/11"
 TBI 14-3343-30 30 cm/12"
 TBI 14-3343-34 33 cm/13"



Satterlee
 TBI 14-3344-31
 31 cm/12 1/2"



Charriere
 TBI 14-3345-27 27 cm/11"
 TBI 14-3345-30 30 cm/12"



Satterlee
 TBI 14-3346-31
 31 cm/12 1/2"



TBI 14-3347-23
 23 cm/9"



TBI 14-3348-19
 19 cm/7 1/2"



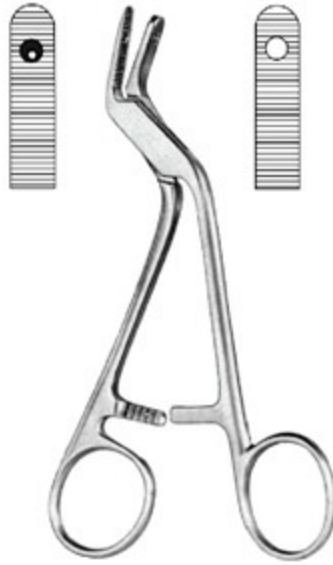

ADSON
TBI 14-3349-15
15 cm/6"



LANE
TBI 14-3350-18
18 cm/7"



LANE
TBI 14-3351-23
23 cm/9"

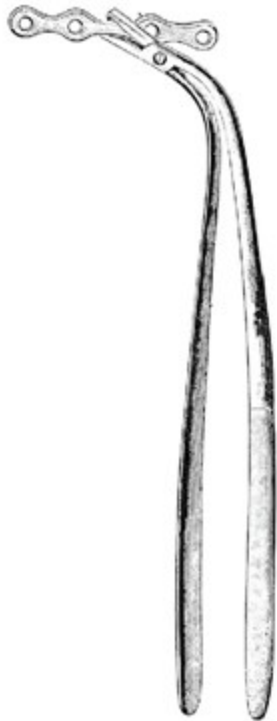

LANE
TBI 14-3352-23
23 cm/9"



LANE
TBI 14-3353-18
18 cm/7"



TBI 14-3354-25
25.5 cm/10"



TBI 14-3355-25
 25 cm/10"



PHILLIPS
 TBI 14-3356-25
 25 cm/10"



LANE
 TBI 14-3357-17 17 cm/6 3/4"
 TBI 14-3358-25 25 cm/10"



WILLIAMS
 TBI 14-3359-24 Flat
 TBI 14-3360-24 Cross Slot
 24 cm/9 1/2"





HEXAGONAL
 TBI 14-3361-25 2.5mm
 TBI 14-3362-25 3.5mm
 TBI 14-3363-25 4.5mm
 25 cm/10"



PHILLIPS
 TBI 14-3364-25
 25 cm/10"



TBI 14-3365-25
 25 cm/10"



LANE
 TBI 14-3366-17 17 cm/6 1/2"
 TBI 14-3367-25 25 cm/10"



TBI 14-3368-14
14.5 cm/5 1/2"



TBI 14-3369-00



TBI 14-3370-00 Screw driver set, complete in case
 TBI 14-3371-00 Sterilizing case only



TBI 14-3372-00



TBI 14-3373-00



TBI 14-3374-00



TBI 14-3375-00



TBI 14-3376-00
 TBI 14-3377-00





TBI 14-3378-2
2.4mm



TBI 14-3379-3
3.2mm



TBI 14-3380-4
4.8mm



TBI 14-3381-6
6.4cm



TBI 14-3382-14
14 cm/5 1/2"



TBI 14-3383-14
14 cm/5 1/2"



PERTHES
TBI 14-3384-21
21 cm/8 1/2"



TABB
TBI 14-3385-02 2.4mm
TBI 14-3385-03 3.2mm
TBI 14-3385-04 4.8mm
TBI 14-3385-06 6.4mm



TBI 14-3386-16
 16.5 cm/6 1/2"



TBI 14-3387-16
 16 cm/6 1/2"



TBI 14-3388-15
 15 cm/6"



TBI 14-3389-17
 17 cm/6 3/4"



TBI 14-3390-18
 18 cm/7"



TBI 14-3391-18
 18 cm/7"





17 cm/6 3/4"

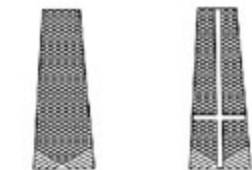

TBI 14-3392-17 TBI 14-3393-17



18 cm/7"



TBI 14-3394-18 TBI 14-3395-18 TBI 14-3396-18



parallel action

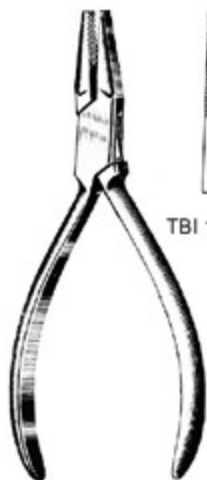

14 cm/5 1/2"



TBI 14-3397-14 TBI 14-3398-14



TBI 14-3399-16
16 cm/6 1/4"



TBI 14-3400-19
19.5 cm/7 3/4"





PARHAM

TBI 14-3401-18 18 cm/7"
 TBI 14-3401-20 20 cm/8"
 TBI 14-3401-25 25 cm/10"
 TBI 14-3401-30 30 cm/12"



PARHAM

TBI 14-3402-22
 22 cm/9 1/4"

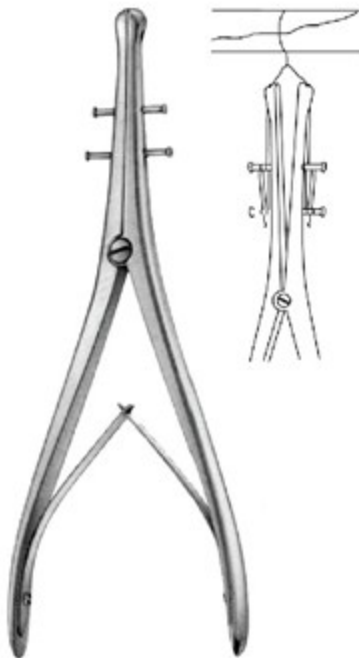

DEMEL

TBI 14-3403-28
 28 cm/11"



LOUTE

TBI 14-3404-21
 21 cm/8 1/4"



LLOYD

TBI 14-3405-00





	soft	hard
0.2mm Ø	TBI 14-3406-02	
0.3mm Ø	TBI 14-3406-03	TBI 14-3407-03
0.4mm Ø	TBI 14-3406-04	TBI 14-3407-04
0.5mm Ø	TBI 14-3406-05	
0.6mm Ø	TBI 14-3406-06	TBI 14-3407-06
0.7mm Ø	TBI 14-3406-07	
0.8mm Ø	TBI 14-3406-08	TBI 14-3407-08
0.9mm Ø	TBI 14-3406-09	
1.0mm Ø	TBI 14-3406-10	TBI 14-3407-10
1.2mm Ø	TBI 14-3406-12	
1.5mm Ø	TBI 14-3406-15	



DEMEL

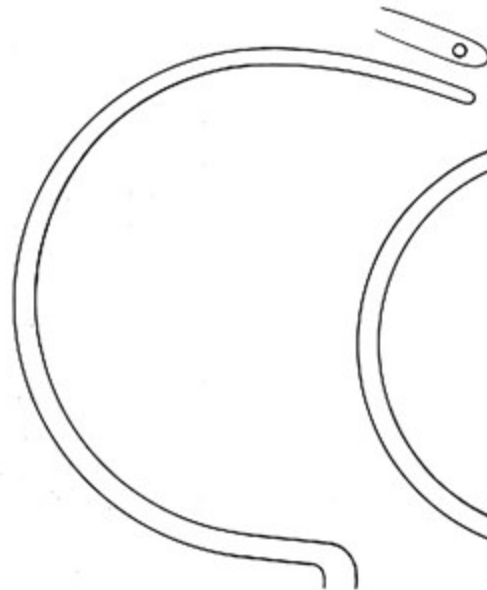

TBI 14-3408-00

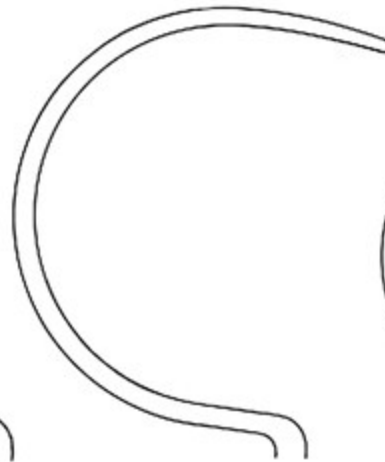

TBI 14-3409-00



TBI 14-3410-00



KUENTSCHER
 TBI 14-3411-21
 21 cm/8 1/4"



KUENTSCHER
 TBI 14-3412-21
 21 cm/8 1/4"



KUENTSCHER
 TBI 14-3413-63
 63 cm/26"
 complete set



TBI 14-3416-63



TBI 14-3417-63



TBI 14-3414-63



TBI 14-3415-63

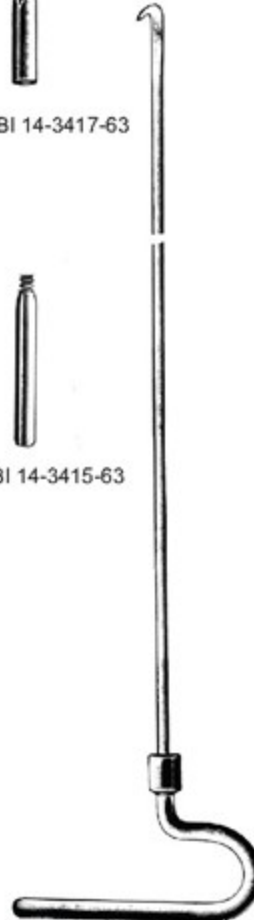

TBI 14-3418-29 29 cm/11 3/4"
 TBI 14-3418-37 37 cm/15"
 TBI 14-3418-42 42 cm/16 3/4"
 TBI 14-3418-49 49 cm/19 3/4"



TBI 14-3419-00



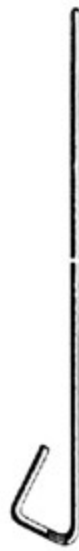

	L=35cm	L=46cm	L=60cm
2.5mm Ø	TBI 14-3420-25	TBI 14-3421-25	
3.0mm Ø	TBI 14-3420-30	TBI 14-3421-30	
3.5mm Ø	TBI 14-3420-35	TBI 14-3421-35	TBI 14-3422-35
4.0mm Ø	TBI 14-3420-40	TBI 14-3421-40	TBI 14-3422-40
5.0mm Ø	TBI 14-3420-50	TBI 14-3421-50	TBI 14-3422-50



KUENTSCHER
 TBI 14-3423-25
 25.5 cm/10"



KUENTSCHER
 TBI 14-3424-35
 35 cm/14"



STEINMANN
 4mm Ø (Trocar tip)
 TBI 14-3425-14 140mm
 TBI 14-3425-16 160mm
 TBI 14-3425-18 180mm
 TBI 14-3425-20 200mm



SCHANZ
 4mm Ø (Flat tip)
 TBI 14-3426-06 60mm
 TBI 14-3426-08 80mm
 TBI 14-3426-10 100mm



SCHANZ
 6mm Ø (Flat tip)
 TBI 14-3427-10 100mm
 TBI 14-3427-13 130mm
 TBI 14-3427-16 160mm
 TBI 14-3427-19 190mm



SCHANZ
 5mm Ø (Trocar tip)
 TBI 14-3428-10 100mm
 TBI 14-3428-12 125mm
 TBI 14-3428-15 150mm
 TBI 14-3428-17 170mm
 TBI 14-3428-20 200mm
 TBI 14-3428-25 250mm

KIRSCHNER
trocar point
flat end



mm ø	60 mm	120mm	140mm	160mm	310mm
0.6	TBI 14-3429-06				
0.8	TBI 14-3429-08				
1.0	TBI 14-3429-10	TBI 14-3430-10	TBI 14-3431-10	TBI 14-3432-10	TBI 14-3433-10
1.2	TBI 14-3429-12	TBI 14-3430-12	TBI 14-3431-12	TBI 14-3432-12	TBI 14-3433-12
1.4	TBI 14-3429-14	TBI 14-3430-14	TBI 14-3431-14	TBI 14-3432-14	TBI 14-3433-14
1.5	TBI 14-3429-15	TBI 14-3430-15	TBI 14-3431-15	TBI 14-3432-15	TBI 14-3433-15
1.6	TBI 14-3429-16	TBI 14-3430-16	TBI 14-3431-16	TBI 14-3432-16	TBI 14-3433-16
1.8	TBI 14-3429-18	TBI 14-3430-18	TBI 14-3431-18	TBI 14-3432-18	TBI 14-3433-18
2.0	TBI 14-3429-20	TBI 14-3430-20	TBI 14-3431-20	TBI 14-3432-20	TBI 14-3433-20
2.2	TBI 14-3429-22	TBI 14-3430-22	TBI 14-3431-22	TBI 14-3432-22	TBI 14-3433-22
2.5	TBI 14-3429-25	TBI 14-3430-25	TBI 14-3431-25	TBI 14-3432-25	TBI 14-3433-25

KIRSCHNER
trocar point
round end



mm ø	60 mm	120mm	140mm	160mm	310mm
1.0	TBI 14-3434-10	TBI 14-3435-10	TBI 14-3436-10	TBI 14-3437-10	TBI 14-3438-10
1.2	TBI 14-3434-12	TBI 14-3435-12	TBI 14-3436-12	TBI 14-3437-12	TBI 14-3438-12
1.4	TBI 14-3434-14	TBI 14-3435-14	TBI 14-3436-14	TBI 14-3437-14	TBI 14-3438-14
1.5	TBI 14-3434-15	TBI 14-3435-15	TBI 14-3436-15	TBI 14-3437-15	TBI 14-3438-15
1.6	TBI 14-3434-16	TBI 14-3435-16	TBI 14-3436-16	TBI 14-3437-16	TBI 14-3438-16
1.8	TBI 14-3434-18	TBI 14-3435-18	TBI 14-3436-18	TBI 14-3437-18	TBI 14-3438-18
2.0	TBI 14-3434-20	TBI 14-3435-20	TBI 14-3436-20	TBI 14-3437-20	TBI 14-3438-20
2.2	TBI 14-3434-22	TBI 14-3435-22	TBI 14-3436-22	TBI 14-3437-22	TBI 14-3438-22
2.5	TBI 14-3434-25	TBI 14-3435-25	TBI 14-3436-25	TBI 14-3437-25	TBI 14-3438-25

KIRSCHNER
lancet point
flat end



mm ø	100 mm
1.0	TBI 14-3439-10
1.2	TBI 14-3439-12
1.5	TBI 14-3439-15
1.6	TBI 14-3439-16
1.8	TBI 14-3439-18
2.0	TBI 14-3439-20
2.2	TBI 14-3439-22
2.5	TBI 14-3439-25



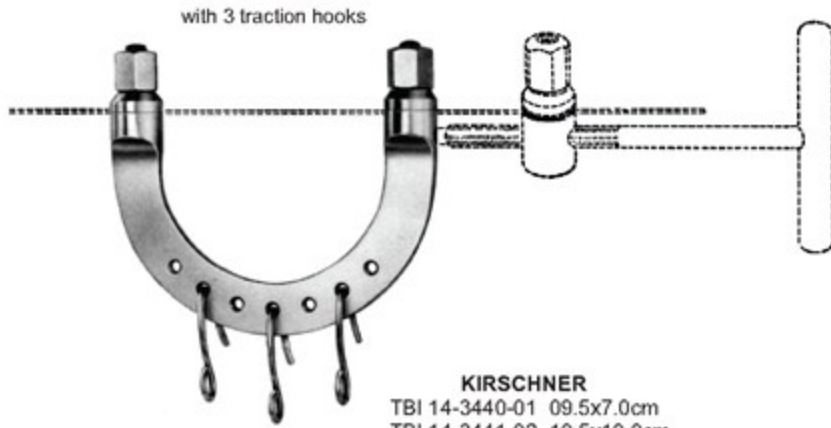

with 3 traction hooks

KIRSCHNER

- TBI 14-3440-01 09.5x7.0cm
- TBI 14-3441-02 10.5x10.0cm
- TBI 14-3442-03 12.0x12.0cm
- TBI 14-3443-04 15.5x15.5cm
- TBI 14-3444-05 20.0x15.5cm



with 3 traction hooks

- KIRSCHNER**
TBI 14-3445-01
6.0x6.0cm

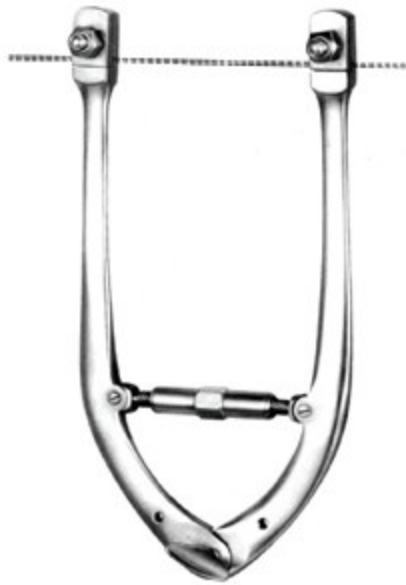

- TBI 14-3446-18 18.0x10.0cm
- TBI 14-3446-27 27.0x27.0cm



- TBI 14-3447-18



- TBI 14-3448-19
19.0cm



- TBI 14-3449-03 TBI 14-3450-06

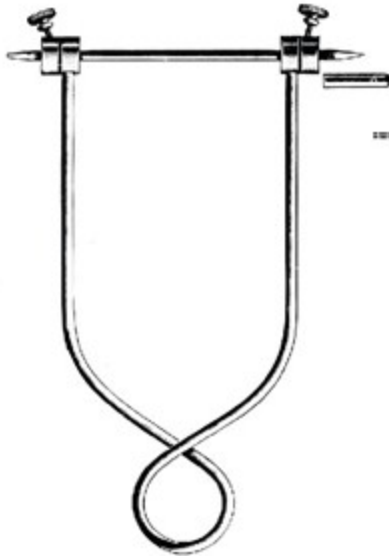

BÖHLER
 TBI 14-3451-15 21.0x15.0cm
 TBI 14-3451-16 16.0x 9.0cm
 TBI 14-3451-21 21.0x11.0cm



KIRSCHNER
 TBI 14-3452-13 13.5cm, infant
 TBI 14-3452-18 18.5cm, child
 TBI 14-3452-27 27.0cm, adult



MARTIN-DIAMANT
 TBI 14-3453-16
 16 cm/6 1/4"



TBI 14-3454-16
 16 cm/6 1/4"



TBI 14-3455-15
 15 cm/6"



TBI 14-3456-23
 23 cm/9"



TBI 14-3456-25
 25 cm/10"



TBI 14-3457-24
 24 cm/9 1/2"



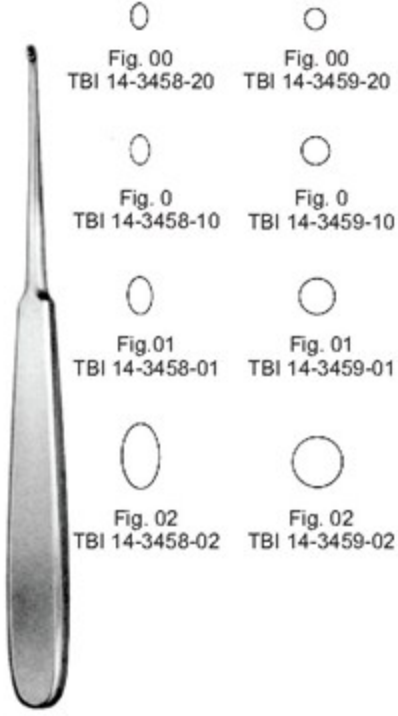

WILLIGER
17.5 cm/7"



BRUNS
23 cm/9"

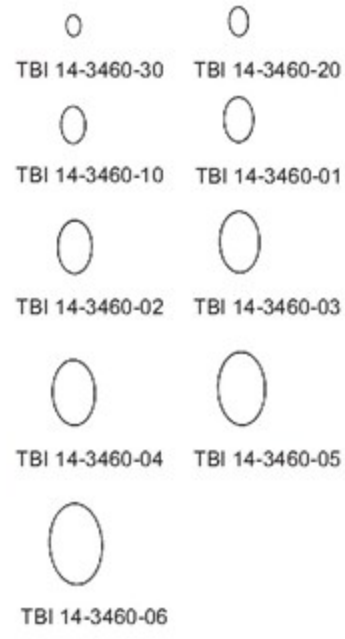

SIMON
24 cm/9 1/2"

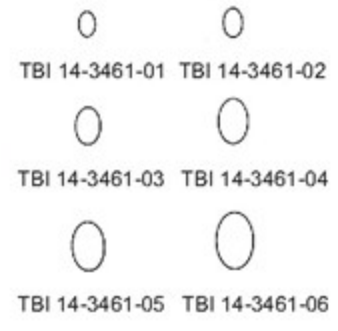



MOD. USA
 16 cm/6 1/4"

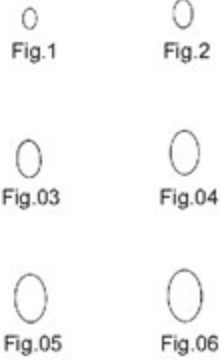

Fig.1 TBI 14-3462-01
 Fig.2 TBI 14-3462-02
 Fig.3 TBI 14-3462-03
 Fig.4 TBI 14-3462-04
 Fig.5 TBI 14-3462-05
 Fig.6 TBI 14-3462-06



TBI 14-3463-01
 TBI 14-3463-02
 TBI 14-3463-03
 TBI 14-3463-04
 TBI 14-3463-05
 TBI 14-3463-06



TBI 14-3464-01
 TBI 14-3464-02
 TBI 14-3464-03
 TBI 14-3464-04
 TBI 14-3464-05
 TBI 14-3464-06



LEMPERT
 17.5 cm/7"



Fig.0 TBI 14-3465-10
 Fig.00 TBI 14-3465-20
 Fig.000 TBI 14-3465-30
 Fig.0000 TBI 14-3465-40
 Fig.00000 TBI 14-3465-50



HALLE
 21 cm/8 1/4"



25 cm/10"





VOLKMANN
17 cm/7"

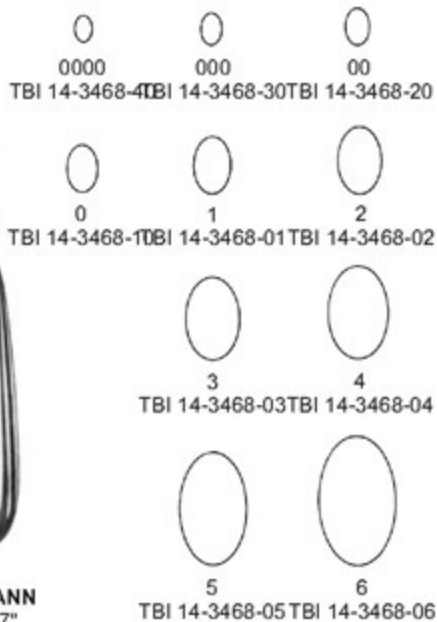

BRUNS
17 cm/7"

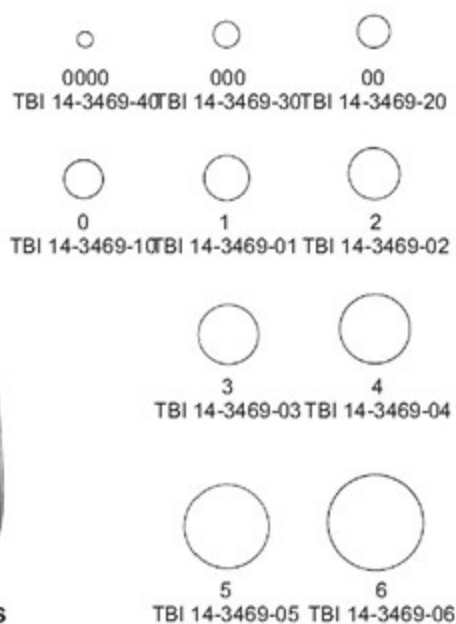

SCHEDE
17 cm/7"

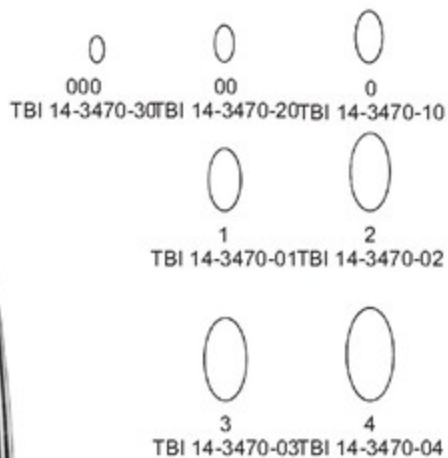

SPRATT
16.5 cm/6 5/8"

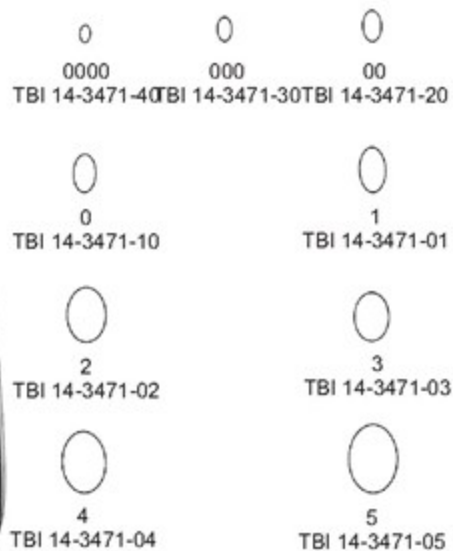

Bone Curettes ●
 Scharfe Löffel ●
 Cucharillas cortantes ●

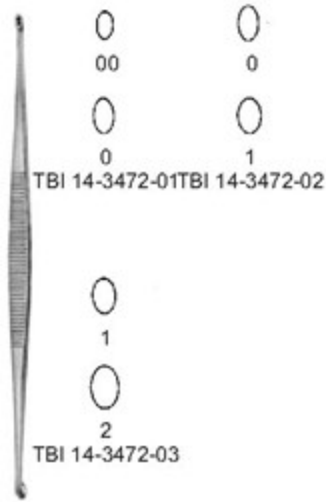

WILLIGER
 13.5 cm/5 1/4"

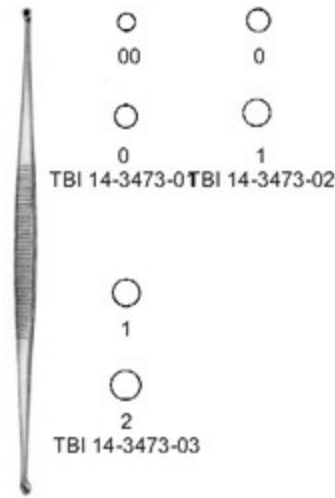

MARTINI
 13.5 cm/5 1/4"



VOLKMANN
 TBI 14-3474-13 13 cm/5"
 TBI 14-3474-14 14 cm/5 1/2"
 TBI 14-3474-17 17 cm/7"



VOLKMANN
 TBI 14-3475-13 13 cm/5 1/4"
 TBI 14-3475-16 16 cm/6 1/4"
 TBI 14-3475-20 20 cm/8"



TBI 14-3476-21
 21 cm/8 1/4"



VOLKMANN
 21.5 cm/8 1/2"





VOLKMANN
17 cm/6 3/4"

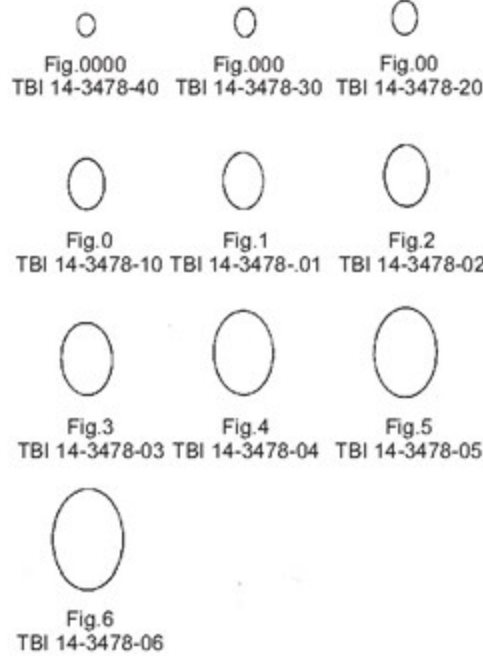



VOLKMANN
27 cm/10 3/4"

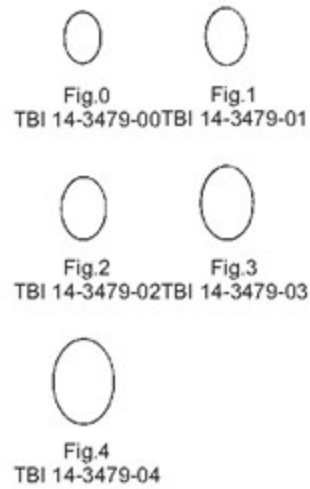



Martin
TBI 14-3482-19
19 cm/7 1/2"



Preston
TBI 14-3483-18
18 cm/7 1/4"

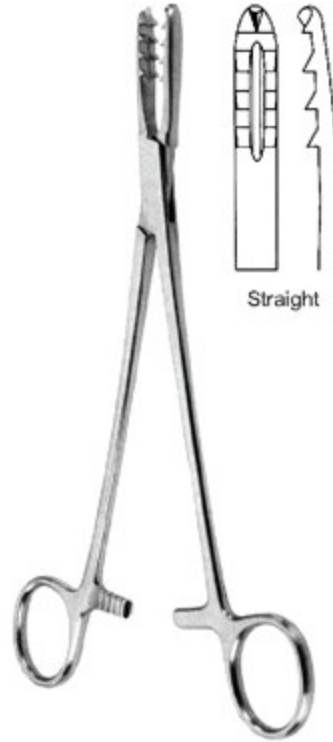

Straight

Bircher-Ganske
TBI 14-3484-20
20 cm/8"

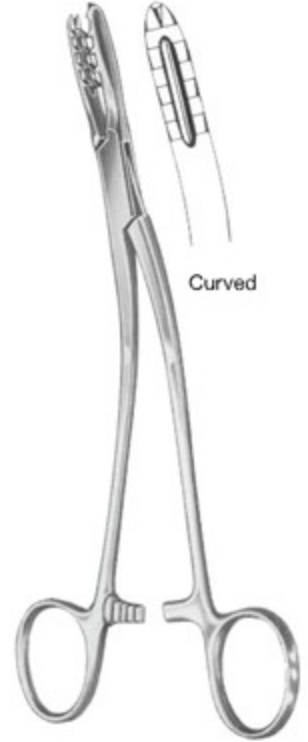

Curved

Bircher-Ganske
TBI 14-3485-20
20 cm/8"



Lewin
TBI 14-3486-17
17.5 cm/7"



Langenbeck
TBI 14-3487-21
21 cm/8 1/4"



Fergusson
TBI 14-3488-21
21 cm/8 1/4"



- Bone Holding Forceps
- Knochenhaltezangen
- Pinzas para huesos



Semb
TBI 14-3495-19
19 cm/7½"



Semb
TBI 14-3496-19
19 cm/7½"



Verbrugge
TBI 14-3497-17
17.5 cm/7"

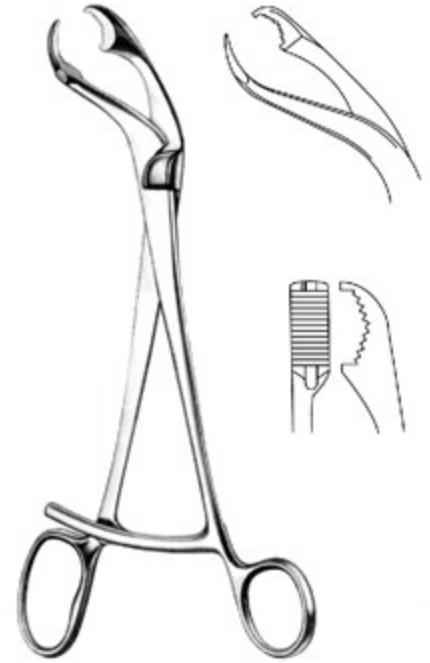

Verbrugge
TBI 14-3498-17
17.5 cm/7"



TBI 14-3499-25
25 cm/10"

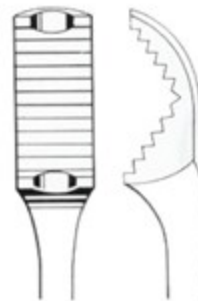
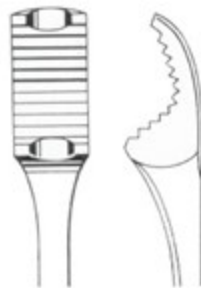

TBI 14-3499-26
26 cm/10¼"
Vebrugge

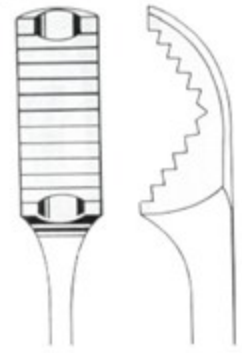

TBI 14-3499-27
27 cm/10½"





TBI 14-3501-16
 16 cm/6¼"
 TBI 14-3501-24
 24 cm/9½"



Without Ratchet
 TBI 14-3502-17
 TBI 14-3502-21

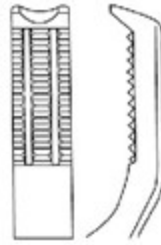

Kern
 cm in
 17 6¾"
 21 8¼"



With Ratchet
 TBI 14-3503-17
 TBI 14-3503-21

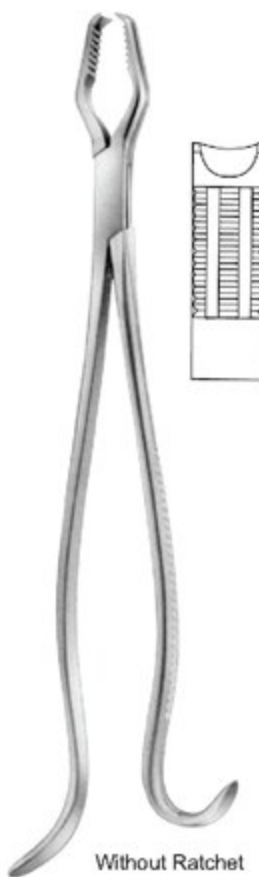

Without Ratchet
 TBI 14-3504-33
 TBI 14-3504-45

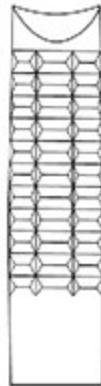

Lane
 cm in
 33 13"
 45 17¾"

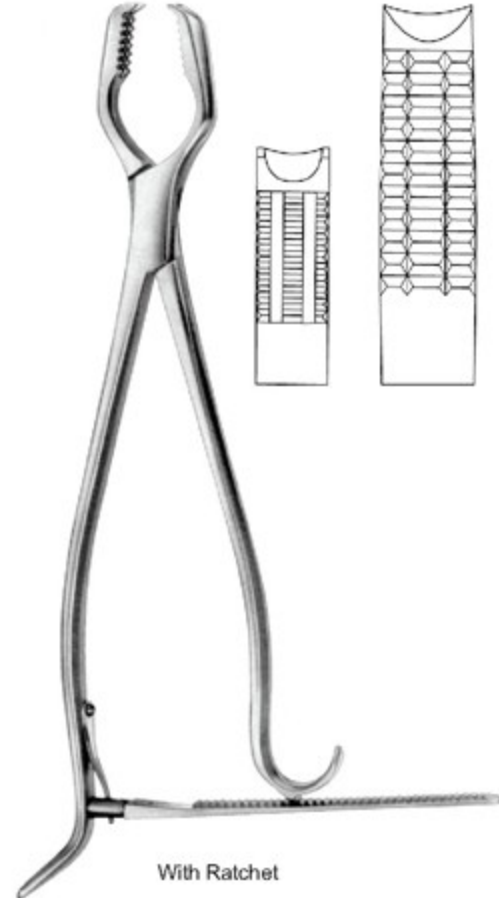

With Ratchet
 TBI 14-3505-33
 TBI 14-3505-45





ULRICH

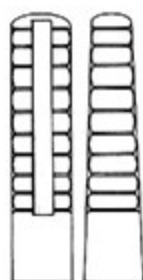

TBI 14-3506-23 23.0cm
 TBI 14-3507-22 22.0cm



TBI 14-3506-25 25.0cm
 TBI 14-3507-24 24.0cm

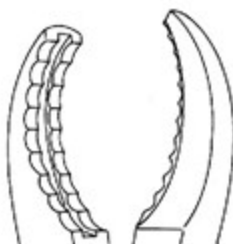

TBI 14-3506-28 28.0cm
 TBI 14-3507-27 27.0cm



ULRICH



TBI 14-3508-19 19 cm/8 3/4"
TBI 14-3508-26 26 cm/10 1/4"



ULRICH
TBI 14-3508-28
28 cm/11"



- Bone Holding Forceps
- Knochenhaltezangen
- Pinzas para huesos



Farabeuf-Lambotte
TBI 14-3509-26
26 cm/10¼"



Lambotte
TBI 14-3510-19 19 cm/7½"
TBI 14-3510-23 23 cm/9"
TBI 14-3510-26 26 cm/10¼"



TBI 14-3511-13
13.5 cm/5 ¼"



Bruns
TBI 14-3511-18
18.5 cm/7 ¼"



TBI 14-3511-14
14.5 cm/5¾"



TBI 14-3512-12
12 cm/4¾"



TBI 14-3512-21
21 cm/8 ¼"



TBI 14-3512-14
14 cm/5 ½"



TBI 14-3513-15 15 cm/6"
 TBI 14-3513-19 19 cm/7½"
 TBI 14-3513-24 24 cm/9½"
 TBI 14-3513-26 26 cm/10¼"
 TBI 14-3513-28 28 cm/11"



Handles Detachable

Percy
 TBI 14-3514-30

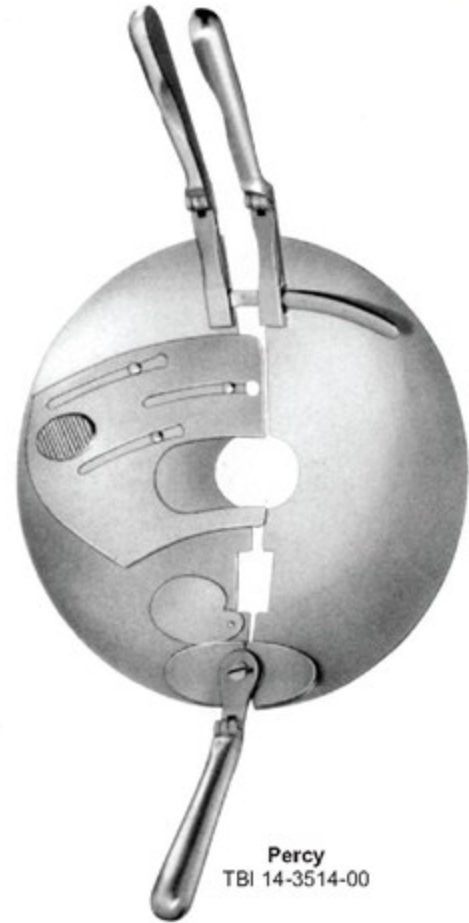

Percy
 TBI 14-3514-00



Adjustable

Lambotte
 TBI 14-3515-22 22 cm/8¼"
 TBI 14-3515-27 27 cm/10½"
 TBI 14-3515-30 30 cm/12"



Farabeuf
 TBI 14-3516-23 23 cm/9"
 TBI 14-3516-26 26 cm/10¼"



Lambotte
 TBI 14-3517-22 22.5 cm/9"
 TBI 14-3517-25 25.5 cm/10½"
 TBI 14-3517-33 33 cm/13½"



Haase
 TBI 14-3517-16
 16.5 cm/6 ½"





TBI 14-3518-19
19 cm/7 3/4"



TBI 14-3519-23
23 cm/9"



TBI 14-3520-25
25 cm/10"



FROSCH
TBI 14-3521-18
18 cm/7"



TBI 14-3522-20
20 cm/8"



TBI 14-3523-18
18.5 cm/7 1/2"



TBI 14-3524-40
40 cm/16"



TBI 14-3525-40
40 cm/16"





TUFFIER
 TBI 14-3526-27
 27 cm/10 3/4"



TBI 14-3527-19 19 cm/7 3/4"
 TBI 14-3527-26 26 cm/10 1/4"



ULRICH
 TBI 14-3528-28
 28 cm/11"



TBI 14-3529-13
13.5 cm/5 1/4"



TBI 14-3530-20
20 cm/8"





Reall
TBI 14-3531-17
17 cm/6¾"



Patella Forceps

TBI 14-3532-17
17.5 cm/7"



LOWMAN	GERSTER-LOWMANN	LAMBERT-LOWMAN	LOWMAN-HOGLUND
TBI 14-3533-12 12.0cm	TBI 14-3534-18 18.0cm	2x2 prongs	TBI 14-3536-12 12.0cm
TBI 14-3533-18 18.5cm	TBI 14-3534-20 20.0cm	TBI 14-3535-18 18.0cm	TBI 14-3536-17 17.5cm
TBI 14-3533-20 20.0cm	TBI 14-3534-22 22.0cm	TBI 14-3535-20 20.0cm	TBI 14-3536-20 20.0cm
TBI 14-3533-22 22.0cm		TBI 14-3535-22 22.0cm	TBI 14-3536-22 22.0cm



GERSTER
TBI 14-3537-15



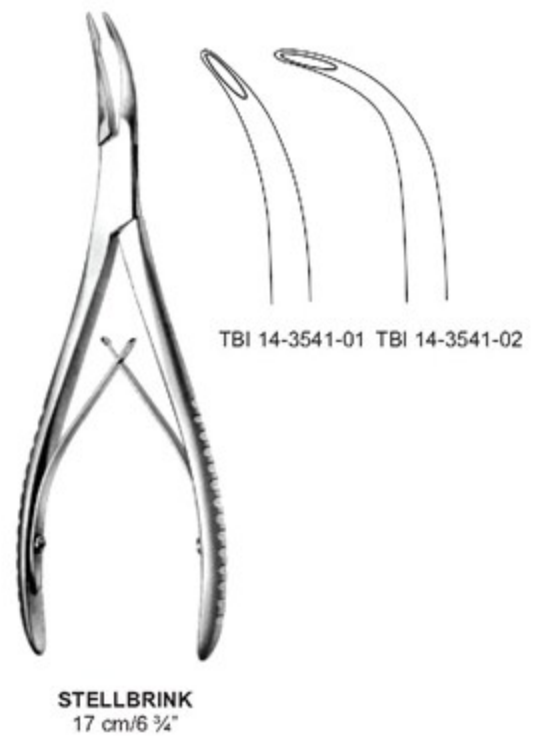



MINI-FRIEDMAN
 TBI 14-3543-12
 12 cm/4 ¾"



FRIEDMAN
 TBI 14-3544-14
 14 cm/5 ½"



MEAD
 TBI 14-3545-16
 16.5 cm/6 ½"



MEAD
 TBI 14-3546-16
 16.5 cm/6 ½"



HARTMANN
 TBI 14-3547-16
 16 cm/6 ¼"



HARTMANN
 TBI 14-3548-18
 18.5 cm/7 ¼"





JANSEN
18 cm/7"

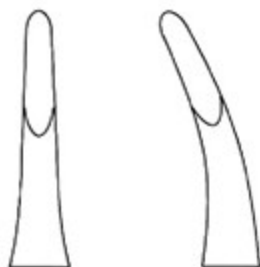

TBI 14-3552-01 TBI 14-3552-02



TBI 14-3552-03



BLUMENTHAL
15 cm/6"



TBI 14-3553-01 TBI 14-3553-02



TBI 14-3553-03



LEMPERT
20 cm/8"



TBI 14-3554-20 TBI 14-3555-20



DEFOURMENTEL
TBI 14-3556-19
19 cm/7 1/2"





BANE
 TBI 14-3557-18
 18 cm/7"



ADSON
 TBI 14-3558-21
 21 cm/8 1/4"



BACON
 TBI 14-3559-20
 20 cm/8"



FISCH
 17 cm/6 3/4"



TBI 14-3560-01



TBI 14-3560-02





LUER
 TBI 14-3561-01
 15 cm/6"



LUER
 TBI 14-3561-02
 15 cm/6"



LUER
 TBI 14-3561-03
 15 cm/6"



LUER
 TBI 14-3562-01
 15 cm/6"



LUER
 TBI 14-3562-02
 15 cm/6"

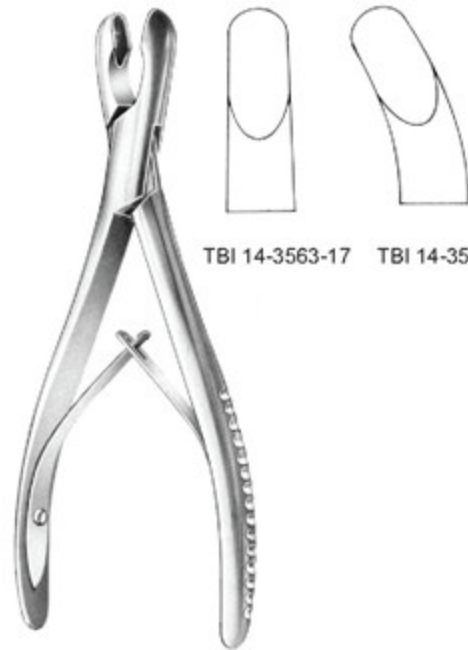

TBI 14-3563-17 TBI 14-3564-17

LUER
 17 cm/6 3/4"

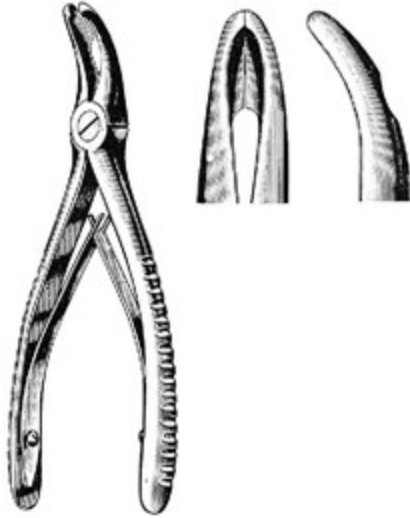

UNIVERSAL
 TBI 14-3565-13
 13.5 cm/5 1/4"

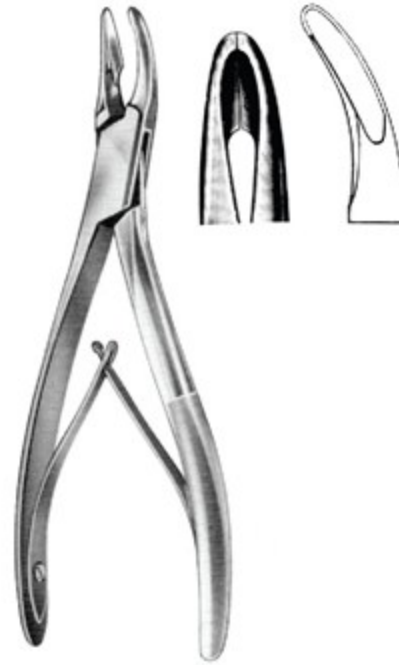

SHELL
 TBI 14-3566-17
 17 cm/6 3/4"



COTTLE-JANSEN
 TBI 14-3567-18
 18 cm/7"



JANSEN
 TBI 14-3568-19
 19 cm/7 1/2"



- Bone Rongeur Forceps
- Hohlmeißelzangen
- Pinzas-gubias



SMITH-PETERSEN
TBI 14-3569-01
24 cm/9 1/2"



SMITH-PETERSEN
TBI 14-3569-02
24 cm/9 1/2"



SMITH-PETERSEN
TBI 14-3569-03
24 cm/9 1/2"



TBI 14-3570-15 TBI 14-3571-15

BÖHLER
 15 cm/6"



3mm

KLEINERT-KUTZ
 TBI 14-3572-15
 15 cm/6"



3mm

GEIGER
 TBI 14-3573-15
 15 cm/6"



BEYER
 TBI 14-3574-18
 18 cm/7"



ZAUFAL-JANSEN
 TBI 14-3575-18
 18 cm/7"



MAYFIELD
 TBI 14-3576-17
 17 cm/6 3/4"



MARQUARDT
 TBI 14-3577-20
 20 cm/8"



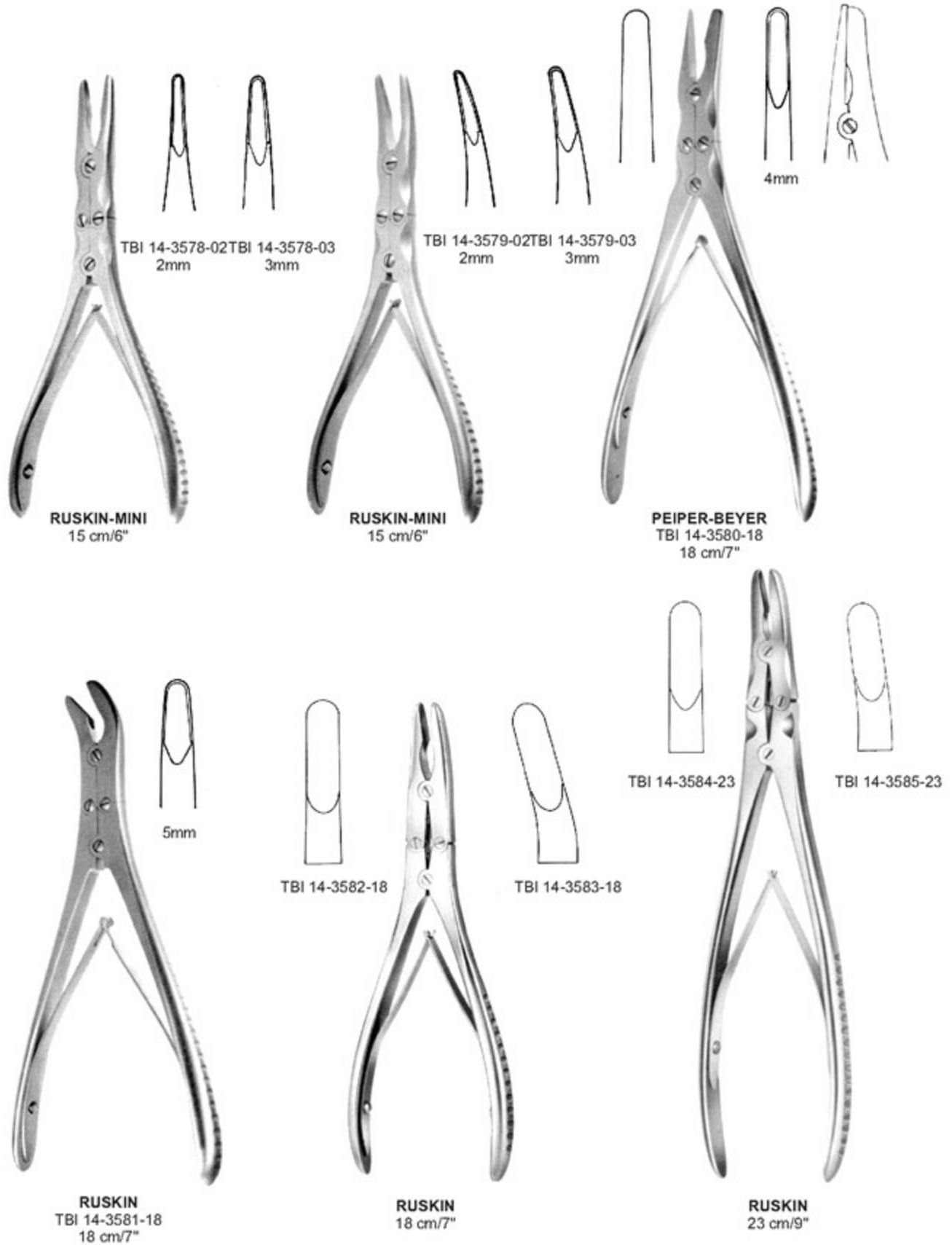



FRYKHOLM
TBI 14-3586-24
24 cm/9 1/2"



TBI 14-3587-02 TBI 14-3587-03 TBI 14-3587-04

ECHLIN
23 cm/9"





STILLE-LEKSELL
 TBI 14-3588-23
 23 cm/9"



LEKSELL
 23 cm/9"



LEKSELL-STILLE
 24 cm/9 1/2"



STILLE
 TBI 14-3591-23
 23 cm/9"



STILLE-RUSKIN
 TBI 14-3592-01 23 cm/9" TBI 14-3592-02



SEMB
 TBI 14-3593-22
 22.5 cm/9"





STILLE-LUER
 TBI 14-3594-01 22 cm/8 3/4" TBI 14-3594-02



STILLE-LUER
 TBI 14-3595-23 23 cm/9" TBI 14-3596-23
 TBI 14-3595-27 27 cm/10 3/4" TBI 14-3596-27



SAUERBRUCH
30 cm/12"



TBI 14-3597-01



TBI 14-3597-02

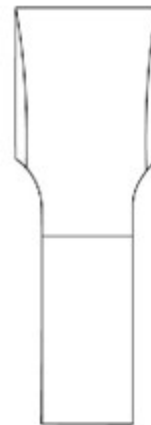

TBI 14-3598-01



TBI 14-3598-02





TBI 14-3599-12
12 cm/5"



CLEVELAND
TBI 14-3600-15
15 cm/6"



CLEVELAND
TBI 14-3601-17
17 cm/6 1/2"

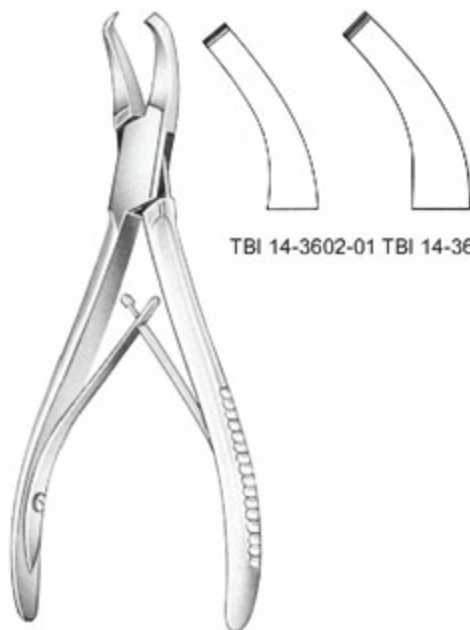

TBI 14-3602-01 TBI 14-3602-02

CLEVELAND
16 cm/6 1/2"

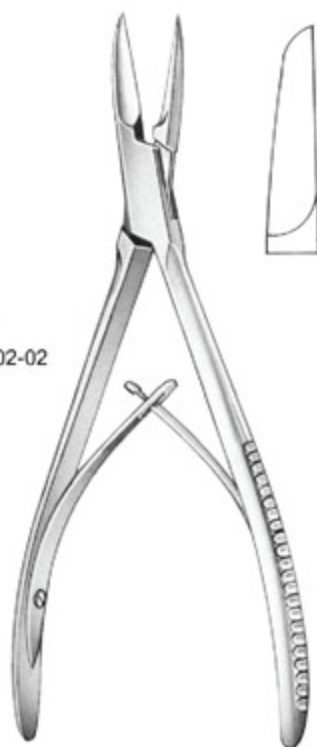

COTTLE-KAZANJIAN
TBI 14-3603-19
19 cm/7 1/2"



MARKWALDER
TBI 14-3604-20
20 cm/8"



LISTON

TBI 14-3605-14 14.0cm TBI 14-3606-14
 TBI 14-3605-17 17.0cm TBI 14-3606-17
 TBI 14-3605-19 19.0cm TBI 14-3606-19
 TBI 14-3605-22 22.0cm TBI 14-3606-22



MC INDOE

TBI 14-3607-17
 17.5 cm/7"



Bouler
 TBI 14-3608-15
 15 cm/6"



TBI 14-3609-15

TBI 14-3610-15

15 cm/6"

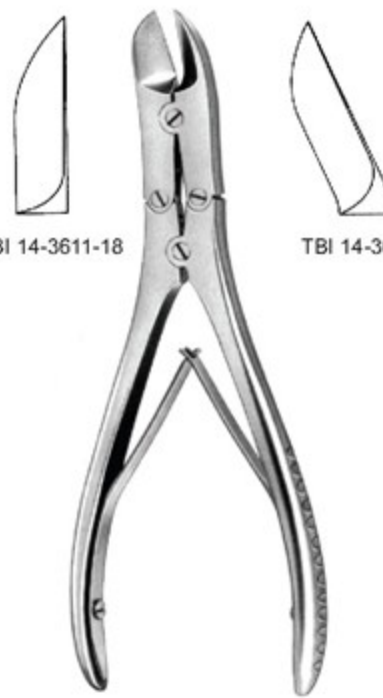

TBI 14-3611-18

TBI 14-3612-18

RUSKIN-LISTON
 18.5 cm/7 1/2"





TUDOR-EDWARDS
 TBI 14-3613-23
 23 cm/9"



SEMB
 TBI 14-3614-24
 24 cm/9 1/4"



STILLE-LISTON
 TBI 14-3615-27
 27 cm/10 3/4"

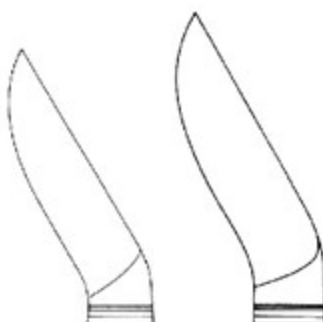

TBI 14-3617-23 TBI 14-3617-27



STILLE LISTON
TBI 14-3616-27
27 cm/10 3/4"



STILLE LISTON
TBI 14-3617-23 23 cm/9"
TBI 14-3617-27 27 cm/10 3/4"



LISTON KEY
TBI 14-3618-27
27 cm/10 3/4"



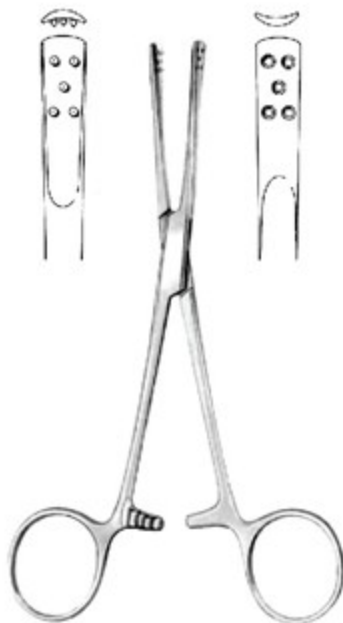

PENNER
 TBI 14-3619-15
 15 cm/6"



RADOLF
 TBI 14-3620-13
 13.5 cm/5 1/2"



TBI 14-3621-01 saw
 TBI 14-3621-02 key

TBI 14-3621-00
 17 cm/7"



TBI 14-3622-01 saw
 TBI 14-3622-02 key

TBI 14-3622-00
 17 cm/7"



TBI 14-3623-01 saw
 TBI 14-3623-02 key

WALTON
 TBI 14-3623-00
 16 cm/5 1/2"



TBI 14-3624-01 saw
 TBI 14-3624-02 key

TBI 14-3624-00



TBI 14-3625-26
26.5 cm/10 1/2"



TBI 14-3626-27
27 cm/10 3/4"



TBI 14-3627-28
28 cm/11"



TBI 14-3628-28
28 cm/11"



TBI 14-3629-00





BUNNELL
15 cm/6"

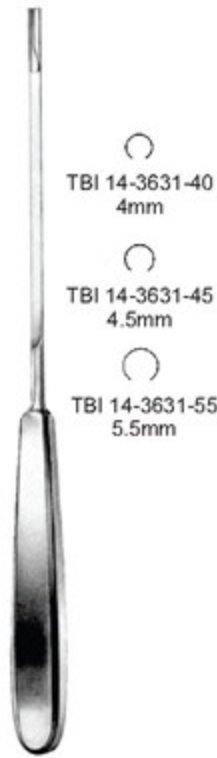

23.0 cm/9"



TBI 14-3632-33
33.5 cm/13"



BUNNEL
TBI 14-3633-23
23 cm/9"



TBI 14-3634-28
28.5 cm/11 1/4"



FISCHER
TBI 14-3635-31
31 cm/10 1/4"



- EN —●— Lead Hands Nail Instruments
- DE —●— Bleihände, Instrumente für Finger- und Zehennägel
- ES —●— Manoplas de plomo, Instrumentos para uñas



IDEAL
TBI 14-3636-00 handle only
TBI 14-3636-01 set



TBI 14-3636-02



TBI 14-3636-03



TBI 14-3636-04



TBI 14-3637-01 adult
TBI 14-3637-02 child

- EN** Plaster Instruments
- DE** Plaster Instrumente
- ES** Instrumentos de yeso

Page 269 to 274



**Lister**

TBI 15-3801-09 09.0 cm/3 1/2"
 TBI 15-3801-11 11.5 cm/4 1/2"
 TBI 15-3801-14 14.0 cm/5 1/2"
 TBI 15-3801-15 15.5 cm/6"
 TBI 15-3801-18 18.0 cm/7"
 TBI 15-3801-20 20.0 cm/8"

**Lister**

TBI 15-3802-18 18.5 cm/7 1/4"
 TBI 15-3802-21 21.0 cm/8 1/4"

**Lister-Excentric**

TBI 15-3803-16 16 cm/5 1/4"
 TBI 15-3803-19 19 cm/7 1/2"

**Esmarch**

TBI 15-3804-20 20 cm/8"
 TBI 15-3804-22 22 cm/8 1/4"

**Bergmann**

TBI 15-3805-23
 23 cm/9"

**Lorenz**

TBI 15-3806-23
 23 cm/9"



Saw edge

TBI 15-3807-17
 17 cm/6¾"



Lange
 TBI 15-3808-18
 18 cm/7"



Bruns
 TBI 15-3809-24
 24 cm/9½"
 TC



Smith (Mod. USA)
 TBI 15-3810-16 16 cm
 TBI 15-3810-18 18 cm
 TBI 15-3810-20 20 cm
 TBI 15-3810-23 23 cm



Knowles
 TBI 15-3811-14
 14 cm/5½"



Knowles
 TBI 15-3812-14
 14 cm/5½"



TBI 15-3813-13
 13 cm/5"





Maier
 TBI 15-3814-15
 15 cm/6"



Schweizer
 TBI 15-3815-18
 18 cm/7"



TBI 15-3816-23
 23 cm/9"



Collin
 TBI 15-3817-22
 22 cm/8¾"



Gluck
 TBI 15-3818-22
 22 cm/8¾"



Stille
 TBI 15-3819-21
 21 cm/8¼"



Utility
 TBI 15-3820-15 15.0cm
 TBI 15-3820-18 18.0cm
 Available in all colors



Bergmann
 TBI 15-3821-18
 18 cm/7"



Engel
 TBI 15-3822-14
 14 cm/5 1/2"

Plaster of paris knives and saws



Hopkins
 TBI 15-3823-20
 20 cm/8"



Esmarch
 TBI 15-3824-18
 18 cm/7"



Reiner
 TBI 15-3825-18
 18 cm/7"



TBI 15-3826-21
 21 cm/8 1/2"



Wigmore
 TBI 15-3827-19
 19 cm/7 1/2"





TBI 15-3828-20 20.0cm



Seutin
TBI 15-3829-23 23.0cm



Bruns
TBI 15-3830-24 24.0cm



Bruns (serrated)
TBI 15-3831-24 24.0cm



Stille-Mini
TBI 15-3832-20 20.0cm



Stille
TBI 15-3833-20 20.0cm
TBI 15-3833-23 23.0cm
TBI 15-3833-26 26.0cm
TBI 15-3833-30 30.0cm
TBI 15-3833-37 37.0cm



Stille
TBI 15-3834-24 24.0cm



Haglund-Stille
 TBI 15-3835-28
 28 cm/11"



USA Mod Spreader
 TBI 15-3836-23
 23 cm/9"



Wolff-Boehler
 TBI 15-3837-18 18 cm/7"
 TBI 15-3837-20 20 cm/8"
 TBI 15-3837-22 22 cm/9"
 TBI 15-3837-24 24 cm/10"
 TBI 15-3837-26 26 cm/11"



Hennig
 TBI 15-3838-28
 28 cm/11"



Beeson
 TBI 15-3839-30
 30 cm/12"



- EN** Retractors
- DE** Wundhaken und -sperrer
- ES** Separadores

Page 275 to 345

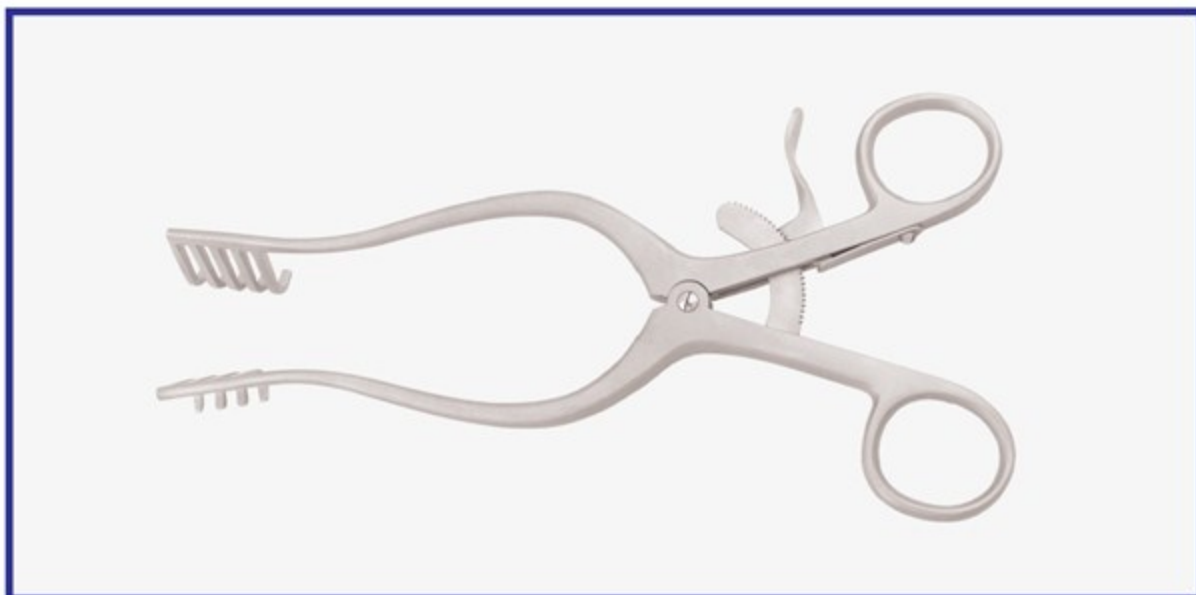



RAGNELL-DAVIS
TBI 16-4201-14
14 cm/5 1/2"



SENN-MILLER
16 cm/6 1/4"



TBI 16-4202-16
sharp prongs



TBI 16-4203-16
blunt prongs

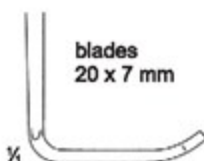

blades
20 x 7 mm

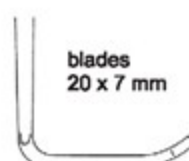

blades
20 x 7 mm



CUSHING
TBI 16-4204-20
20 cm/7 1/2"



CUSHING



20 cm/7 1/2"
24 cm/9 1/2"

TBI 16-4205-20
TBI 16-4208-24
8 mm



TBI 16-4206-20
TBI 16-4209-24
10 mm



TBI 16-4207-20
TBI 16-4210-20
12 mm



20 cm/7 1/2"
24 cm/9 1/2"

TBI 16-4211-20
TBI 16-4214-24
14 mm



TBI 16-4212-20
TBI 16-4215-24
16 mm



TBI 16-4213-20
TBI 16-4216-24
18 mm

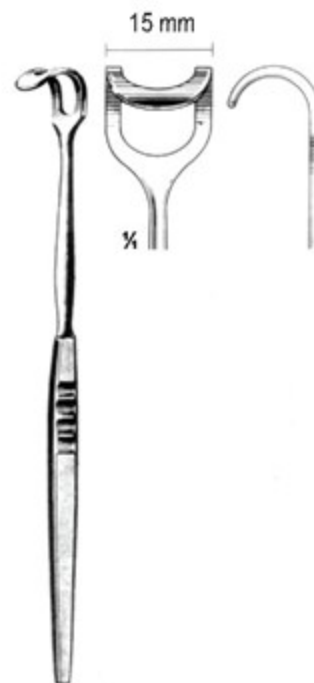

HANDTE
TBI 16-4217-17
17 cm/6 3/4"

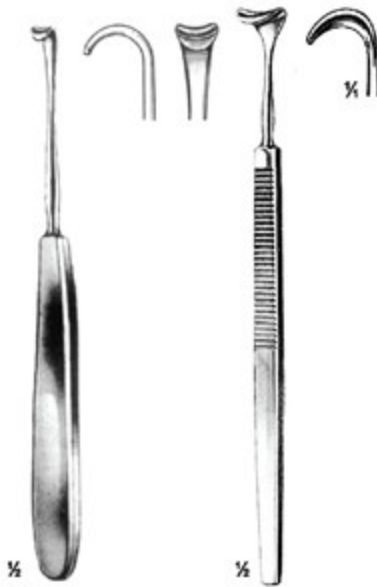

DESMARRES
 TBI 16-4218-16
 16 cm/6 1/4"

DESMARRES
 16 cm/6 1/4"

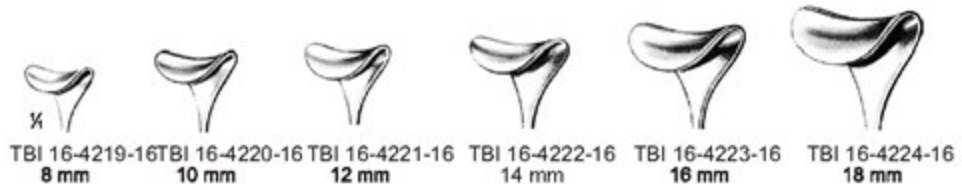

TBI 16-4219-16 8 mm TBI 16-4220-16 10 mm TBI 16-4221-16 12 mm TBI 16-4222-16 14 mm TBI 16-4223-16 16 mm TBI 16-4224-16 18 mm



16 cm/6 1/4"

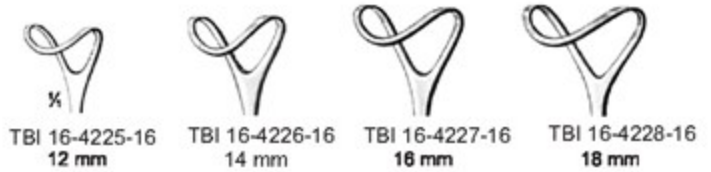

TBI 16-4225-16 12 mm TBI 16-4226-16 14 mm TBI 16-4227-16 16 mm TBI 16-4228-16 18 mm



MINI-LANGENBECK
 16 cm/6 1/4"



TBI 16-4229-16
 10 x 6 mm



TBI 16-4230-16
 17 x 5 mm



TBI 16-4231-16
 20 x 6 mm



TBI 16-4232-16
 22 x 8 mm



MINI-LANGENBECK
 TBI 16-4233-16
 16 cm/6 1/4"

14 x 8 mm
 blunt





MEYERDING
18 cm/7 1/8"



1/4
TBI 16-4234-18
18 x 7 mm



TBI 16-4235-18
16 x 5 mm



1/4
TBI 16-4236-18
7 x 4 mm



TBI 16-4237-18
10 x 3 mm



1/4
TBI 16-4238-18
7 x 4 mm



TBI 16-4239-18
10 x 4 mm



SENN-GREEN
15 cm/5 7/8"



1/4
10 x 6 mm
TBI 16-4240-15



1/4
20 x 6 mm
TBI 16-4241-15



28 x 6 mm



12 x 14 mm

LAHEY
TBI 16-4242-19
19 cm/7 1/2"

LITTLE
TBI 16-4243-20
20 cm/7 7/8"



KLAPP
17.5 cm/6 7/8"



1/4
TBI 16-4244-17
13 x 6 mm



1/4
TBI 16-4245-17
12 x 11 mm



1/4
TBI 16-4246-17
15 x 12 mm



STRANDELL-STILLE
19 cm/7 1/2"



TBI 16-4247-19



TBI 16-4248-19
toothed



1/4
TBI 16-4249-19
19 x 12 mm



1/4
TBI 16-4250-19
21 x 14 mm



KOCHER
19 cm/7 1/2"





LANGENBECK
 22 cm/8 1/2"

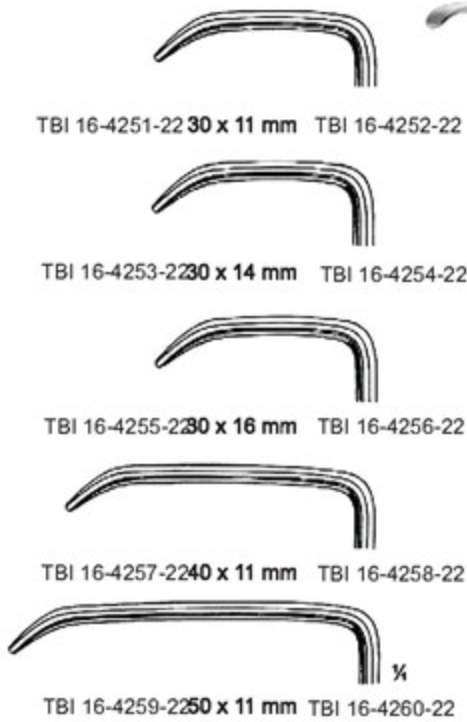

LANGENBECK
 21 cm/8 1/4"



LANGENBECK
 TBI 16-4261-21
 21 cm/8 1/4"



LANGENBECK
 TBI 16-4262-21
 21 cm/8 1/4"





ZENKER

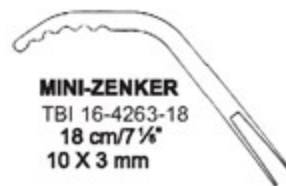

MINI-ZENKER
TBI 16-4263-18
18 cm/7 1/4"
10 X 3 mm

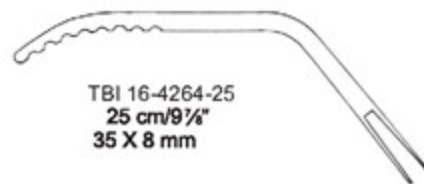

TBI 16-4264-25
25 cm/9 7/8"
35 X 8 mm

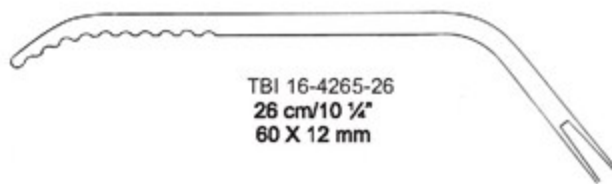

TBI 16-4265-26
26 cm/10 1/4"
60 X 12 mm

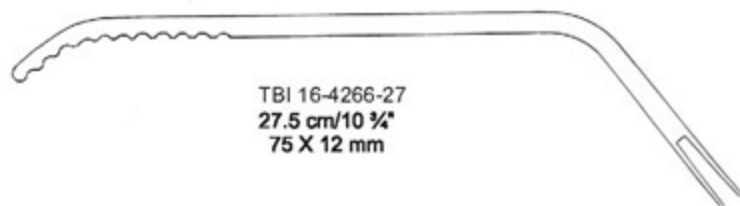

TBI 16-4266-27
27.5 cm/10 3/4"
75 X 12 mm

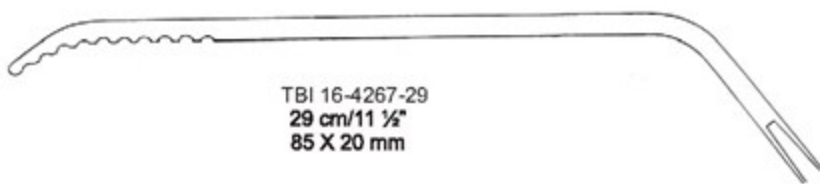

TBI 16-4267-29
29 cm/11 1/2"
85 X 20 mm

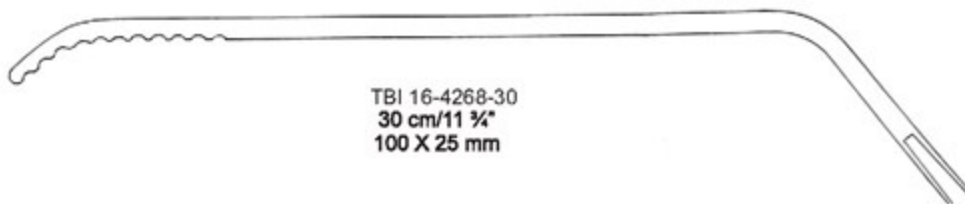

TBI 16-4268-30
30 cm/11 3/4"
100 X 25 mm

RETRACTORS

Retractors — EN
 Wundhaken — DE
 Separadores — ES

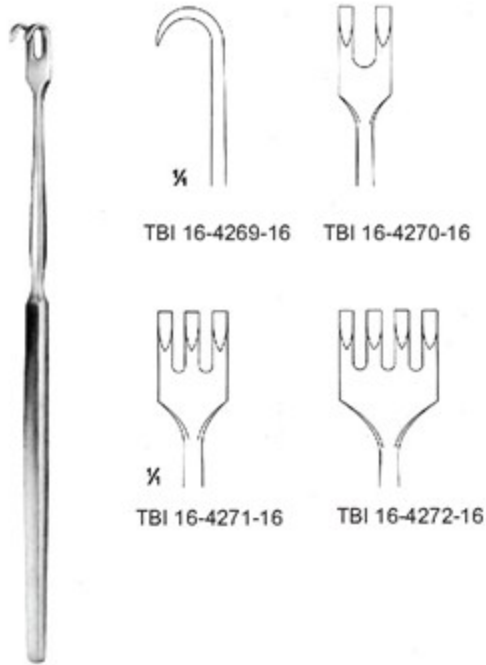

TRACHEAL
 16 cm/6 1/4"
 sharp

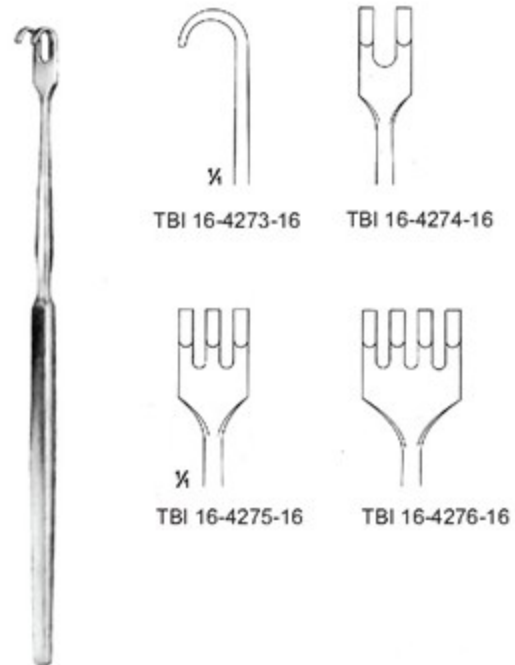

TRACHEAL
 16 cm/6 1/4"
 blunt

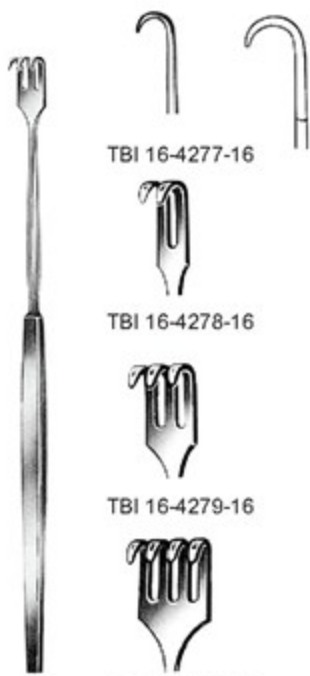

TRACHEAL
 16 cm/6 1/4"
 semi-sharp

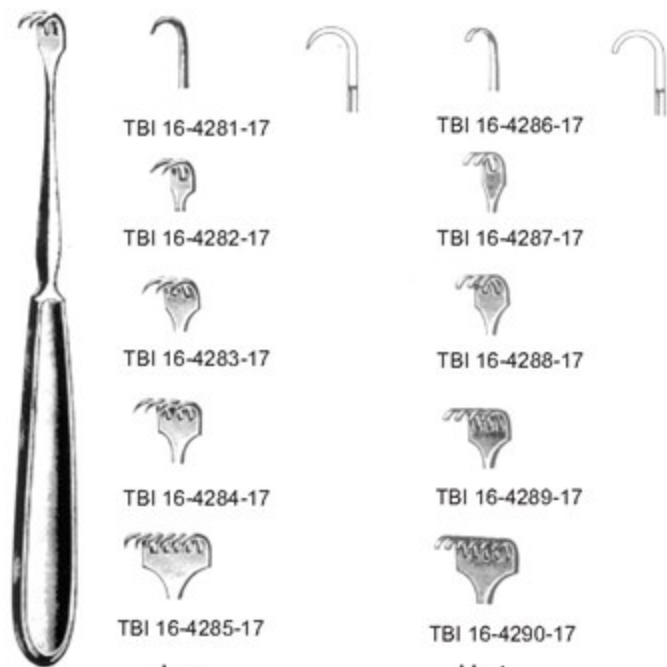

17 cm/6 3/4"

sharp

blunt





16 cm/6 1/4"
flexible



TBI 16-4291-16



TBI 16-4292-16



TBI 16-4293-16



TBI 16-4294-16



TBI 16-4295-16

sharp



TBI 16-4296-16

blunt



16 cm/6 1/4"



TBI 16-4297-16

sharp



TBI 16-4298-16

blunt



VESSEL HOOK
TBI 16-4299-12
12 cm/4 3/4"



VOLKMANN
11.5 cm/4 1/2"



TBI 16-4300-11



TBI 16-4301-11



TBI 16-4302-11



TBI 16-4303-11



TBI 16-4304-11



TBI 16-4305-11



TBI 16-4306-11



TBI 16-4307-11



TBI 16-4308-13
13.5 cm/5 1/4"



16 cm/6 1/4"

TBI 16-4309-16

TBI 16-4310-16

Measurements of retractors: Depth x Width

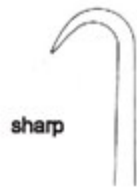

TBI 16-4311-21



TBI 16-4312-21



TBI 16-4313-21



TBI 16-4314-21

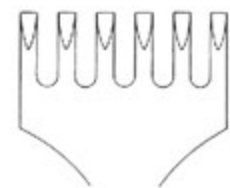

TBI 16-4315-21



TBI 16-4316-21



TBI 16-4317-21



TBI 16-4318-21



TBI 16-4319-21

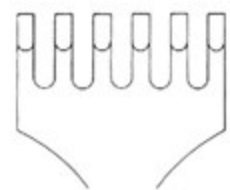

TBI 16-4320-21



VOLKMANN
 21.5 cm/8 ½"



CUSHING
 TBI 16-4321-21
 21.5 cm/8 ½"
 TBI 16-4322-25
 25 cm/10"

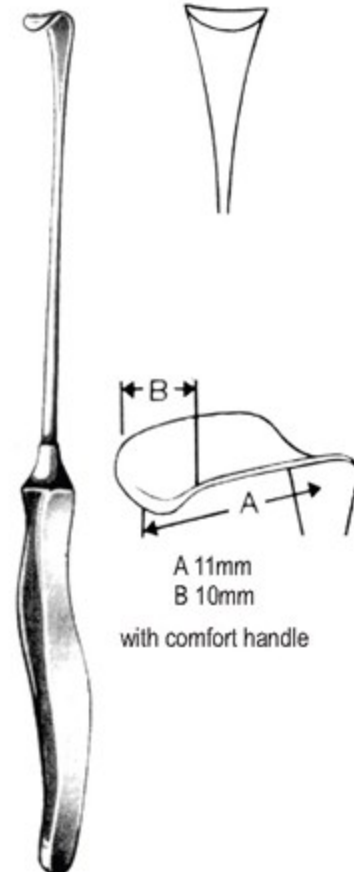

CUSHING
 TBI 16-4323-21
 24.5 cm/9 ¾"
 TBI 16-4324-28
 28 cm/11"





KOCHER
23 cm/9"

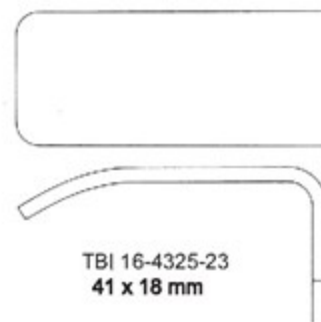

TBI 16-4325-23
41 x 18 mm

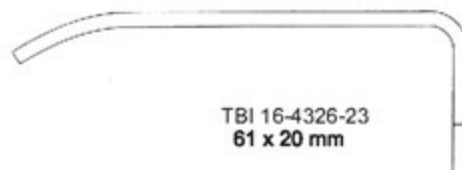

TBI 16-4326-23
61 x 20 mm

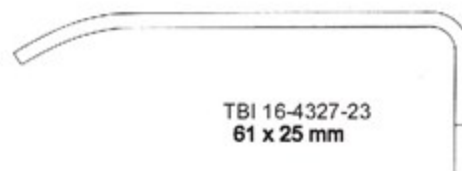

TBI 16-4327-23
61 x 25 mm

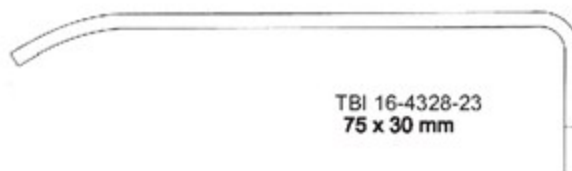

TBI 16-4328-23
75 x 30 mm

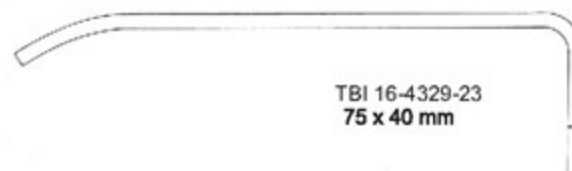

TBI 16-4329-23
75 x 40 mm

X



KOCHER-LANGENBECK
 21.5 cm/8 ½"

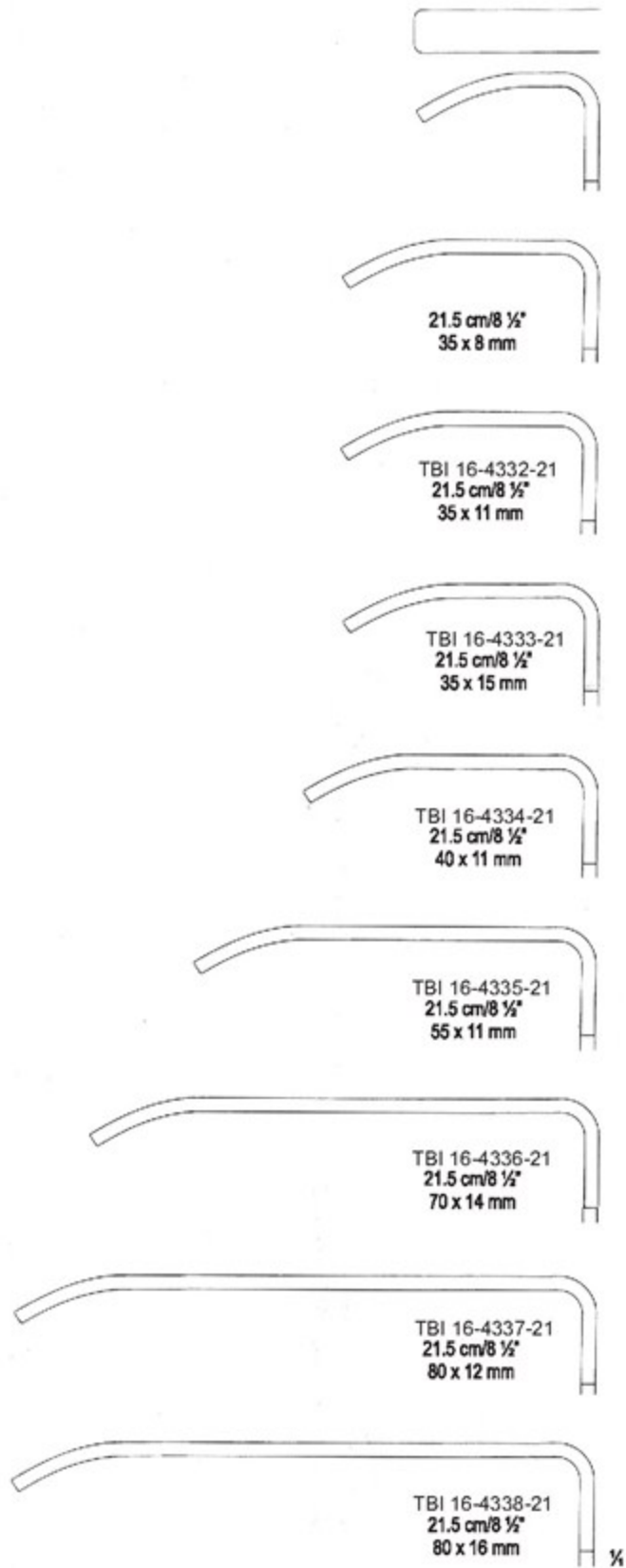

Measurements of retractors: Depth x Width



KOCHER-LANGENBECK
21.5 cm/8 1/2"

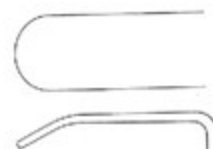

TBI 16-4339-21
21.5 cm/8 1/2"
25 x 10 mm



TBI 16-4340-21
21.5 cm/8 1/2"
40 x 13 mm



TBI 16-4341-21
21.5 cm/8 1/2"
60 x 13 mm



TBI 16-4342-21
21.5 cm/8 1/2"
40 x 18 mm



TBI 16-4343-21
21.5 cm/8 1/2"
60 x 18 mm



TBI 16-4344-21
21.5 cm/8 1/2"
85 x 18 mm



TBI 16-4345-21
21.5 cm/8 1/2"
60 x 25 mm



TBI 16-4346-21
21.5 cm/8 1/2"
85 x 25 mm

Measurements of retractors: Depth x Width



OBWEGESER
 24 cm/9 1/2"
 bent downwards

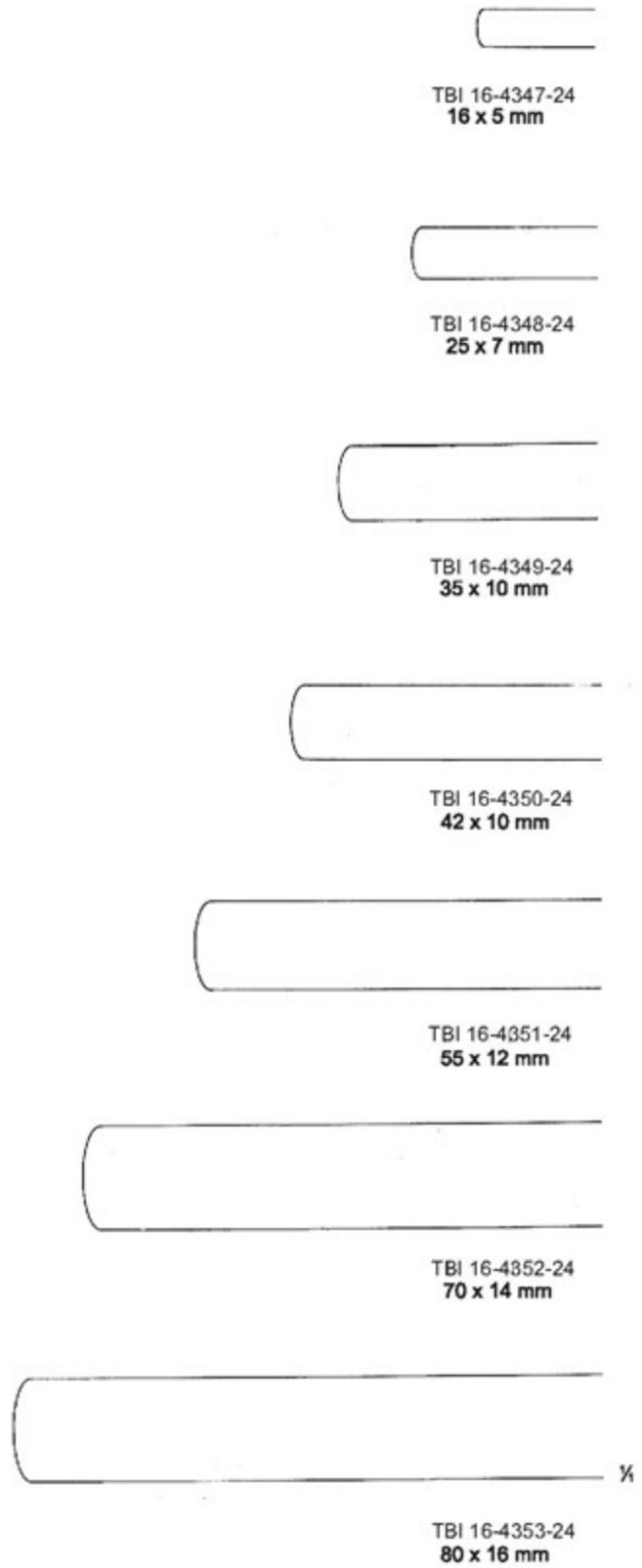

Measurements of retractors: Depth x Width



OBWEGESER
24cm/9 1/2"
bent upward



TBI 16-4354-24
16 x 5 mm

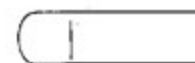

TBI 16-4355-24
25 x 7 mm



TBI 16-4356-24
35 x 10 mm



TBI 16-4357-24
42 x 10 mm



TBI 16-4358-24
55 x 12 mm



TBI 16-4359-24
70 x 14 mm



TBI 16-4360-24
80 x 16 mm

Measurements of retractors: Depth x Width

RETRACTORS

Retractors — EN
 Wundhaken — DE
 Separadores — ES

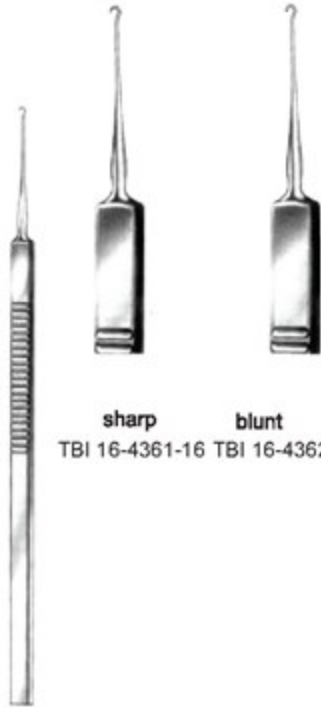

sharp
TBI 16-4361-16

blunt
TBI 16-4362-16

GRAEFE
16 cm/6 1/4"

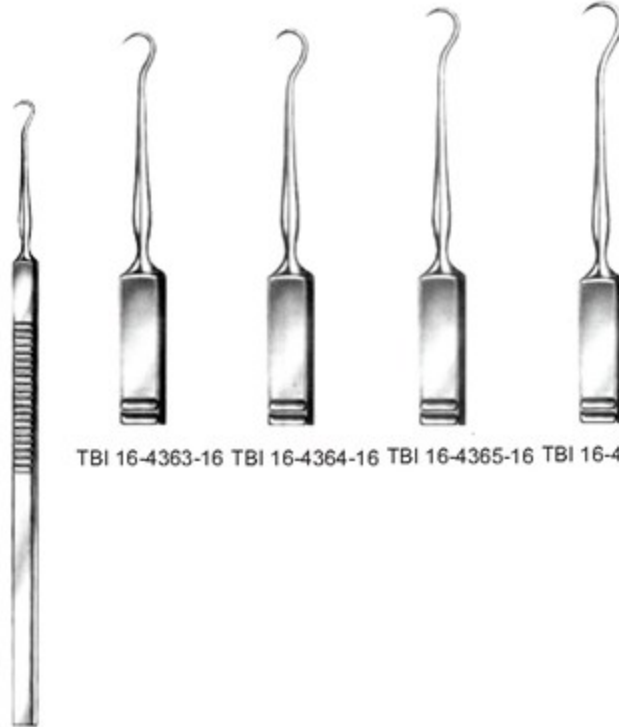

TBI 16-4363-16 TBI 16-4364-16 TBI 16-4365-16 TBI 16-4366-16

GRAEFE
16 cm/6 1/4"



O'CONNOR
TBI 16-4367-16
16 cm/6 1/4"

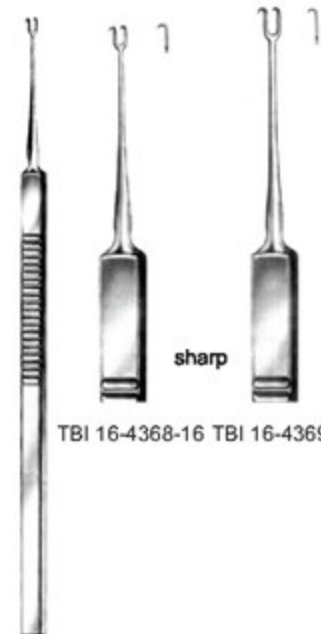

sharp
TBI 16-4368-16 TBI 16-4369-16

GUTHRIE
16 cm/6 1/4"

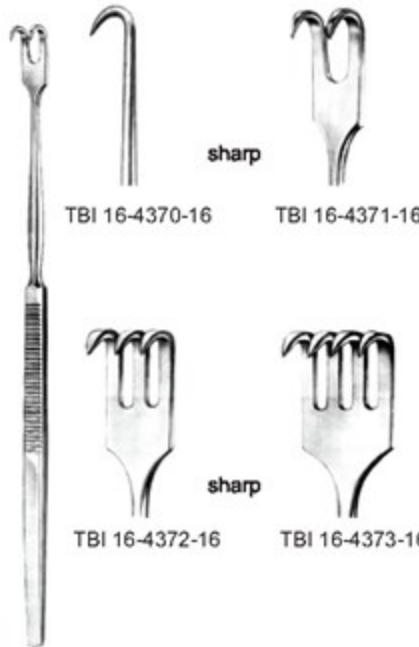

sharp
TBI 16-4370-16 TBI 16-4371-16

sharp
TBI 16-4372-16 TBI 16-4373-16

KEHLENGRIFF
16 cm/6 1/4"

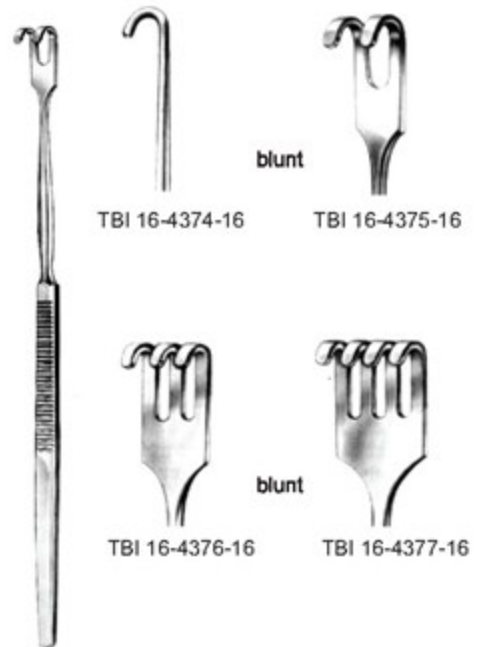

blunt
TBI 16-4374-16 TBI 16-4375-16

blunt
TBI 16-4376-16 TBI 16-4377-16

KEHLENGRIFF
16 cm/6 1/4"

Measurements of retractors: Depth x Width



16 x 5 mm



CANNY RYALL
TBI 16-4378-15 15mm
TBI 16-4378-20 20mm
TBI 16-4378-25 25mm
TBI 16-4378-30 30mm



CANNY RYALL
TBI 16-4379-17 cm/6 3/4"



CANNY RYALL
TBI 16-4380-17 cm/6 3/4"



38 x 22 mm

CZERNEY
TBI 16-4381-177 cm/6 3/4"



TBI 16-4382-23



TBI 16-4383-23

Sharp



TBI 16-4384-23



23 cm/9"



KOCHER
 22 cm/8 1/2"
 TBI 16-4385-2240 x 10 mm
 TBI 16-4386-2240 x 15 mm
 TBI 16-4387-2240 x 20 mm



MIDDELDORPF



14 x 17 mm
 TBI 16-4388-2121.5 cm/8 1/2" TBI 16-4389-21



20 x 22 mm
 TBI 16-4390-2222 cm/8 1/2" TBI 16-4391-21



26 x 30 mm
 TBI 16-4392-223.5 cm/9 1/4" TBI 16-4393-23



MIDDELDORPF



Measurements of retractors: Depth x Width



TBI 16-4394-21



TBI 16-4395-21



TBI 16-4396-21



TBI 16-4397-21



TBI 16-4398-21



sharp



TBI 16-4399-21



TBI 16-4400-21



TBI 16-4401-21



TBI 16-4402-21



TBI 16-4403-21



blunt



TBI 16-4404-21



TBI 16-4405-21



TBI 16-4406-21



TBI 16-4407-21



TBI 16-4408-21



semi-sharp



VOLKMANN
21.5 cm/8 1/2"



TBI 16-4409-21
21.5 cm/8 1/2"



TBI 16-4410-21
21.5 cm/8 1/2"



TBI 16-4411-21 sharp
TBI 16-4412-21 blunt
20 cm/7 1/8"

Measurements of retractors: Depth x Width

RETRACTORS

Retractors — EN
 Wundhaken — DE
 Separadores — ES



KOCHER
 22 cm/8 1/2"

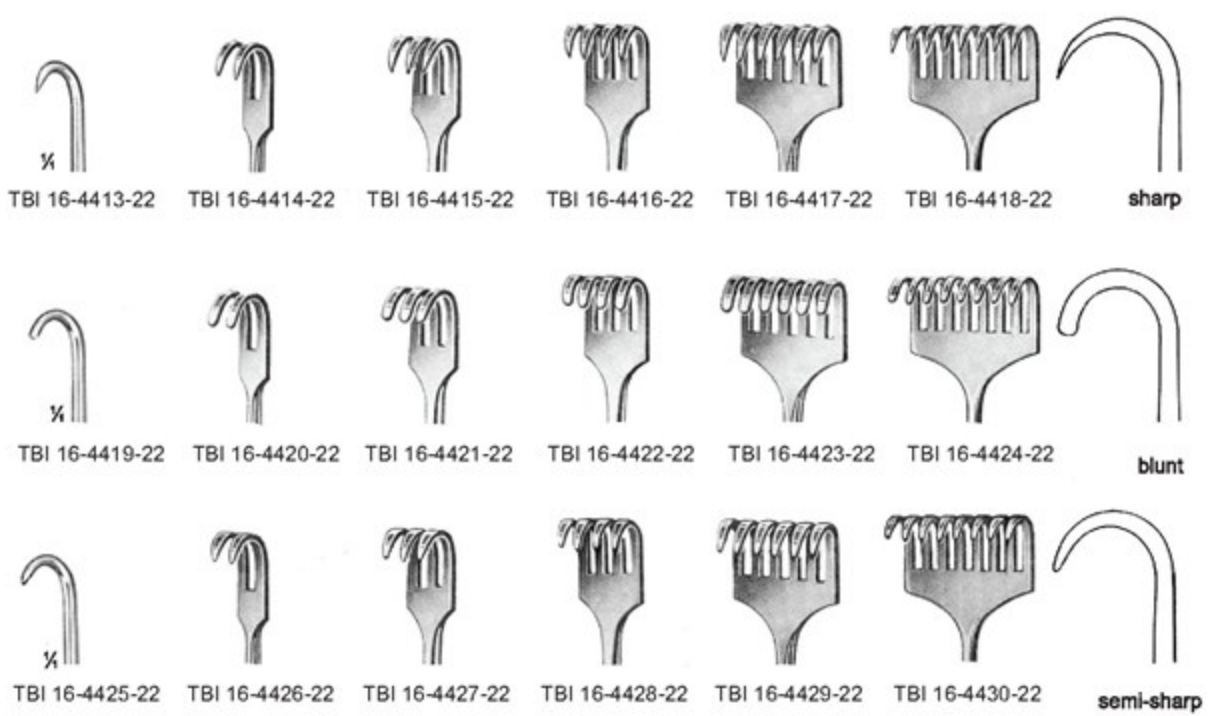

TBI 16-4431-22

OLLIER
 TBI 16-4432-22
 22.5 cm/8 7/8"



WASSMUND
 TBI 16-4433-20
 20 cm/7 7/8"

Measurements of retractors: Depth x Width





TBI 16-4434-27
27 cm/10 1/2"

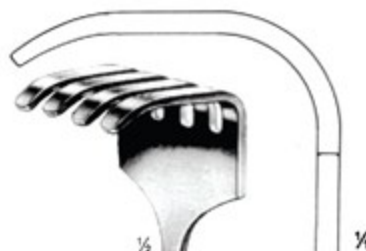

TBI 16-4435-25
40 x 40 mm



TBI 16-4436-25
45 x 50 mm

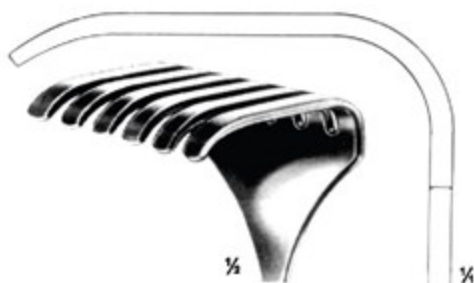

TBI 16-4437-25
50 x 60 mm

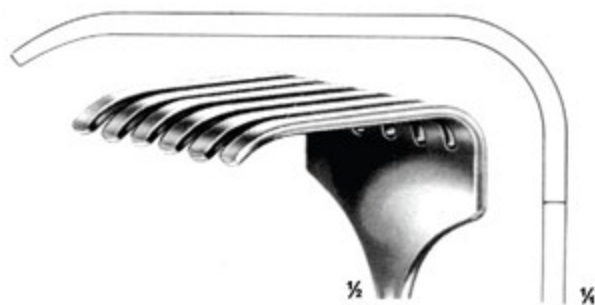

TBI 16-4438-25
70 x 70 mm



ISRAEL
25 cm/9 1/2"

Measurements of retractors: Depth x Width

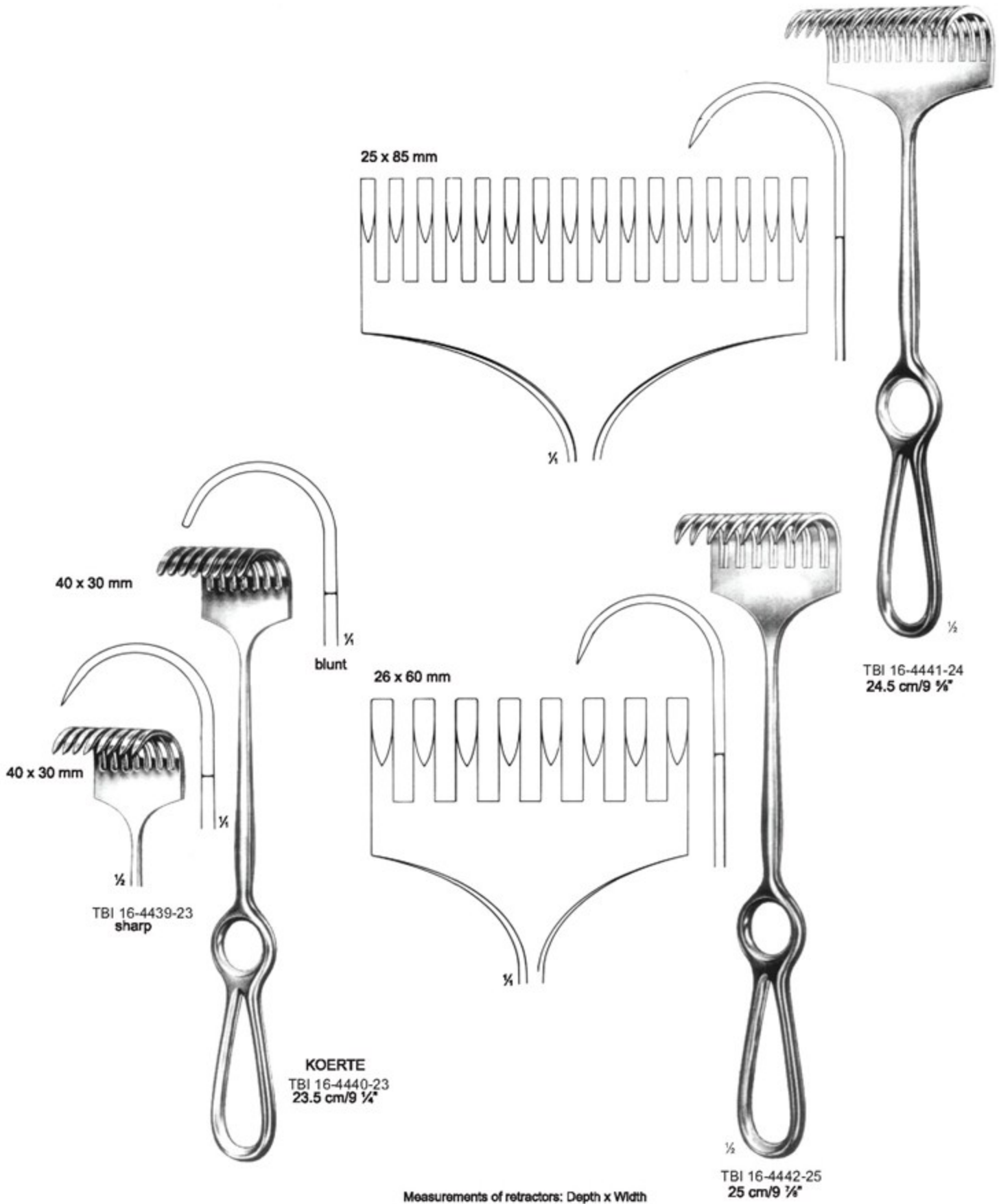



Fig. 1
TBI 16-4443-26
26 cm/10 1/4"
25 x 20 mm
30 x 28 mm

Fig. 2
TBI 16-4444-27
27.5 cm/10 3/4"
43 x 38 mm
63 x 44 mm

RICHARDSON-EASTMAN
TBI 16-4445-1
Set Fig. 1 + 2

RICHARDSON

RICHARDSON
TBI 16-4448-24
24 cm/9 1/2"

KELLY
TBI 16-4449-26 62 x 50 mm
TBI 16-4450-26 70 x 65 mm
26 cm/10 1/4"

TBI 16-4446-23
23.5 cm/9 1/4"
25 x 21 mm

TBI 16-4446-24
24 cm/9 1/2"
30 x 29 mm

TBI 16-4447-24
24 cm/9 1/2"
38 x 40 mm

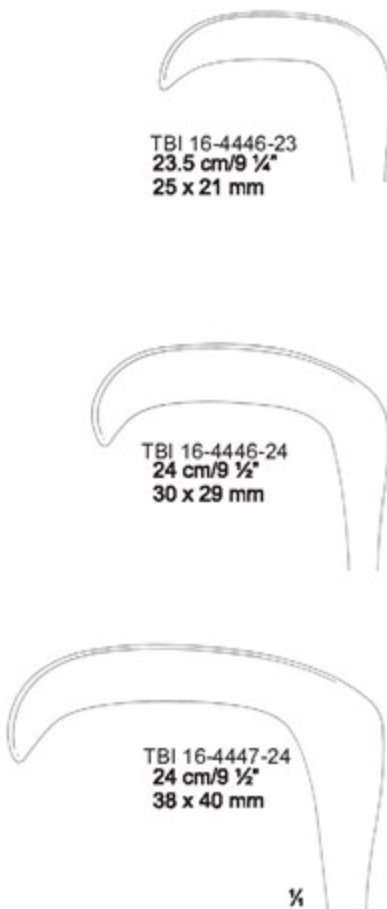



1/4
 TBI 16-4451-28



1/4
 TBI 16-4452-28



1/4
 TBI 16-4453-28

28 cm/11"



1/4
 TBI 16-4454-28
 19 cm 7 1/2"



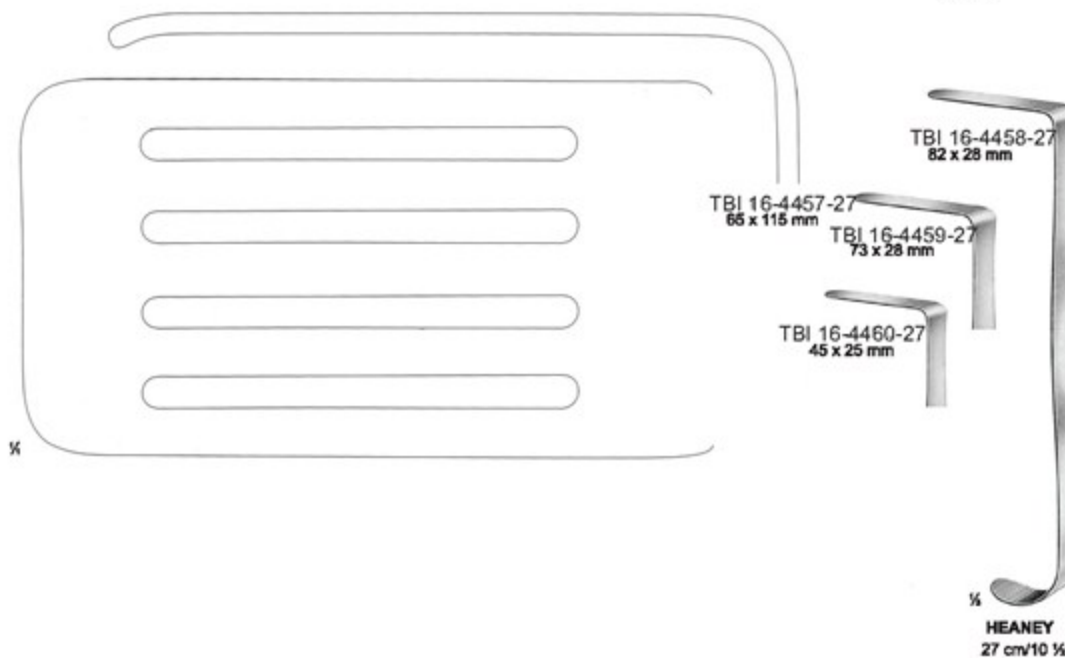
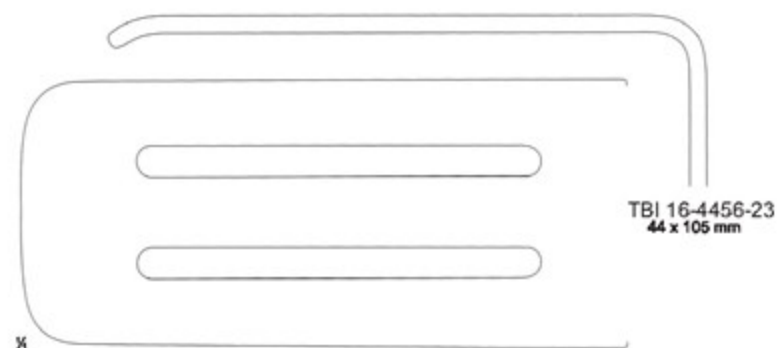
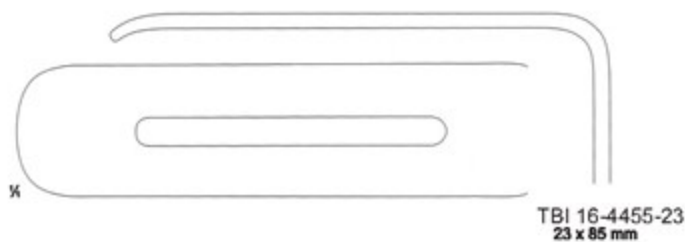



50 x 85 mm

70 x 25 mm

½

½

DOYEN

TBI 16-4461-25
 25 cm/9 ½"

KOCHER

TBI 16-4462-22
 22.5 cm/8 ¾"

KOCHER

	Total length	Blade
	cm in.	mm
TBI 16-4463-25	25 9 ¾"	80 x 45
TBI 16-4464-25	25 9 ¾"	80 x 55
TBI 16-4465-25	25 9 ¾"	80 x 65

TUFFIER

TBI 16-4466-21
 21.5 cm/8 ½"

Measurements of retractors: Depth x width

- Retractors, Abdominal Retractors
- Wundhaken, Bauchdeckenhalter
- Separadores, Separadores abdominales



DOYEN-STILLE

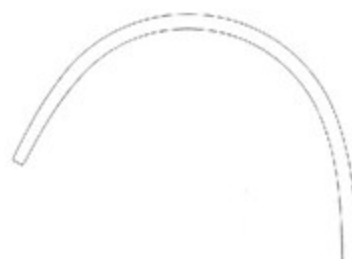

TBI 16-4470-27
 27 cm/10 1/2"
 43 x 45 mm

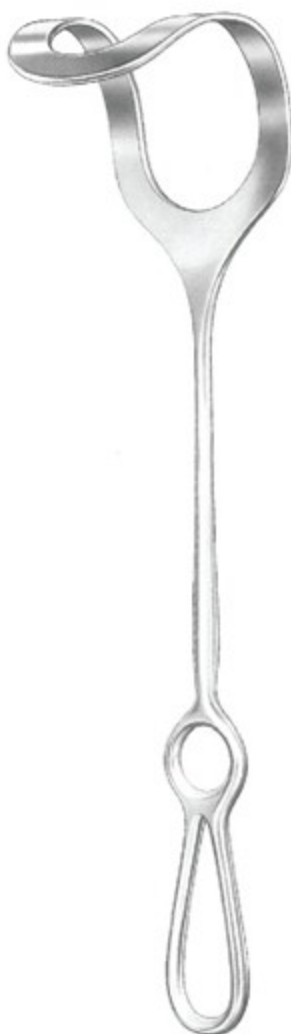

TBI 16-4471-27
 27 cm/10 1/2"
 52 x 50 mm

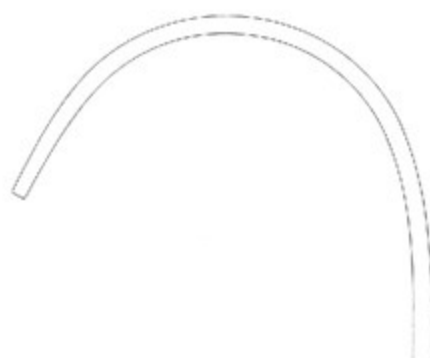

TBI 16-4471-28
 28 cm/11"
 52 x 70 mm

MIDDELDORPF





FRITSCH



TBI 16-4472-23
 23.5 cm/9 1/4"
 37 x 31 mm



TBI 16-4472-24
 24 cm/9 1/2"
 38 x 40 mm



TBI 16-4472-25
 25 cm/9 7/8"
 43 x 51 mm

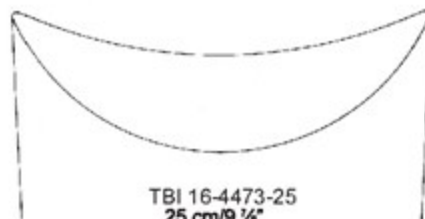

TBI 16-4473-25
 25 cm/9 7/8"
 49 x 61 mm



TBI 16-4474-25
 25.5 cm/10"
 48 x 75 mm

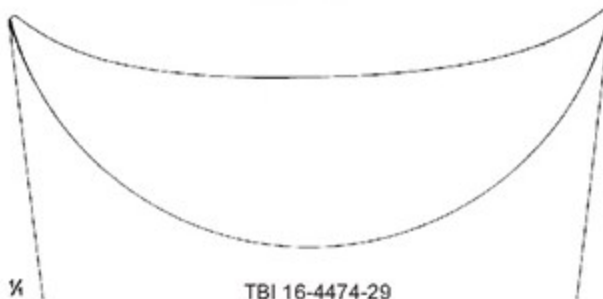

TBI 16-4474-29
 29.5 cm/11 1/4"
 65 x 85 mm



Measurements of retractors: Depth x width



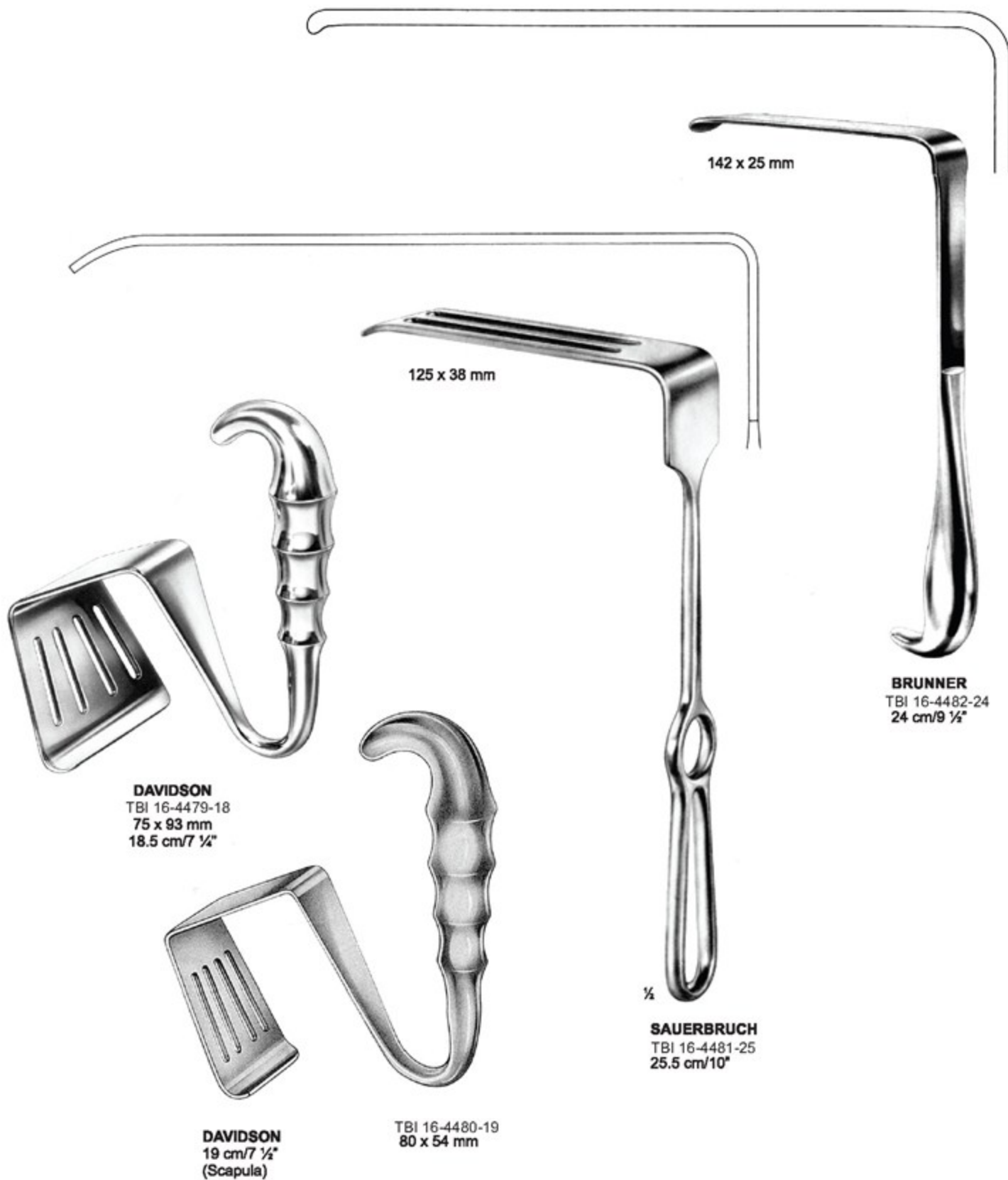

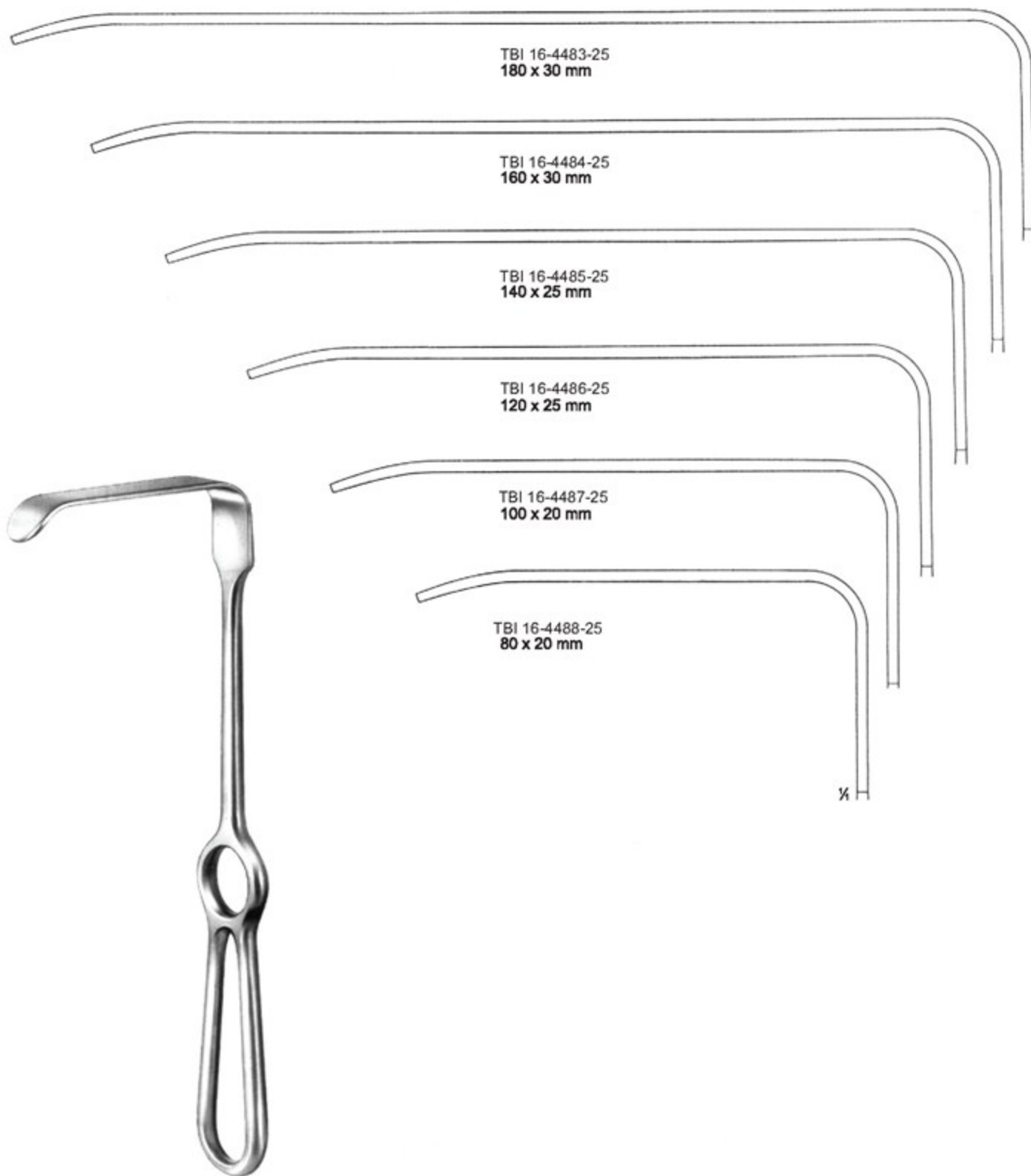

BRUNNER
25 cm/9 3/4"

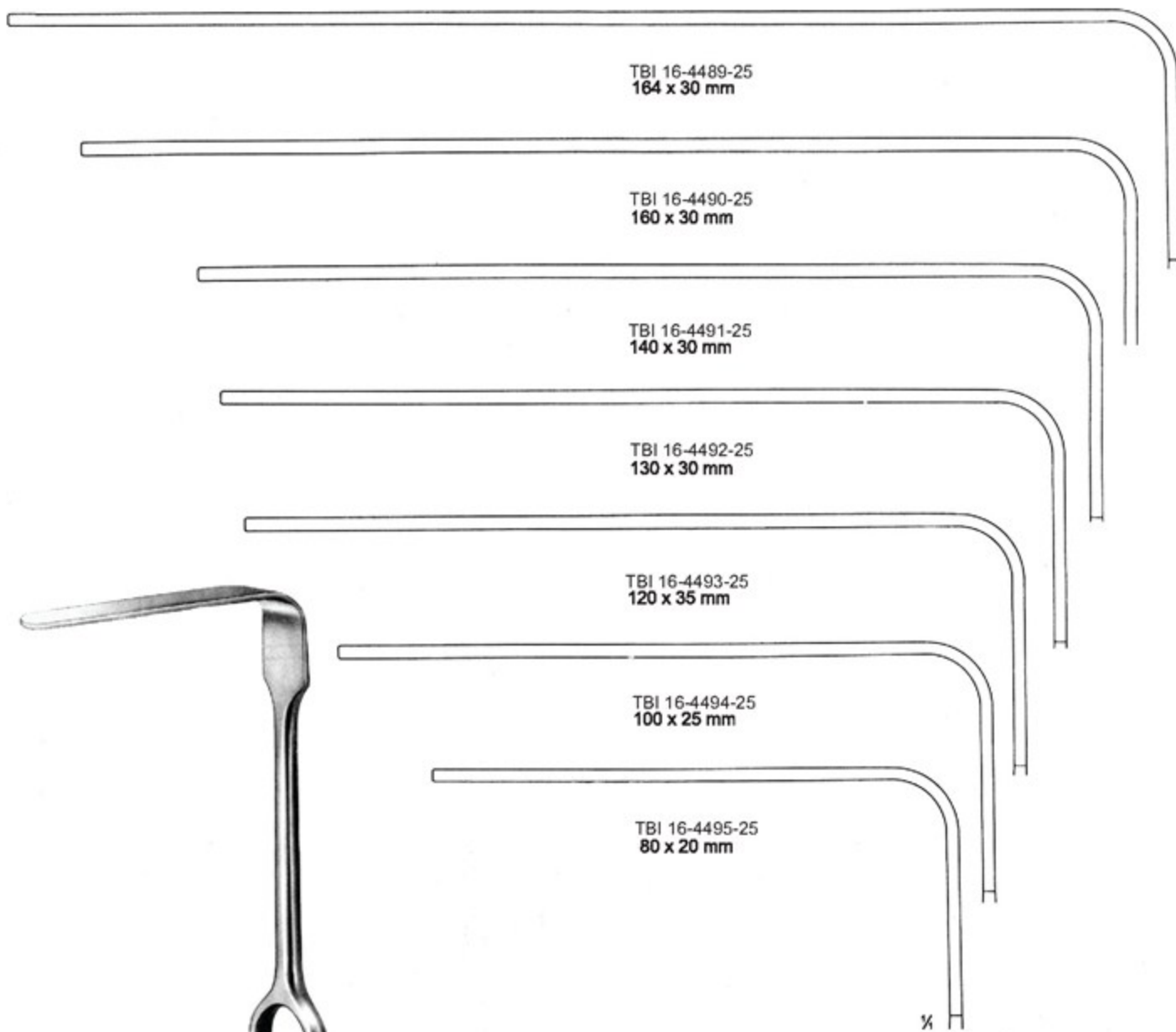

BRUNNER
25.5 cm/10"

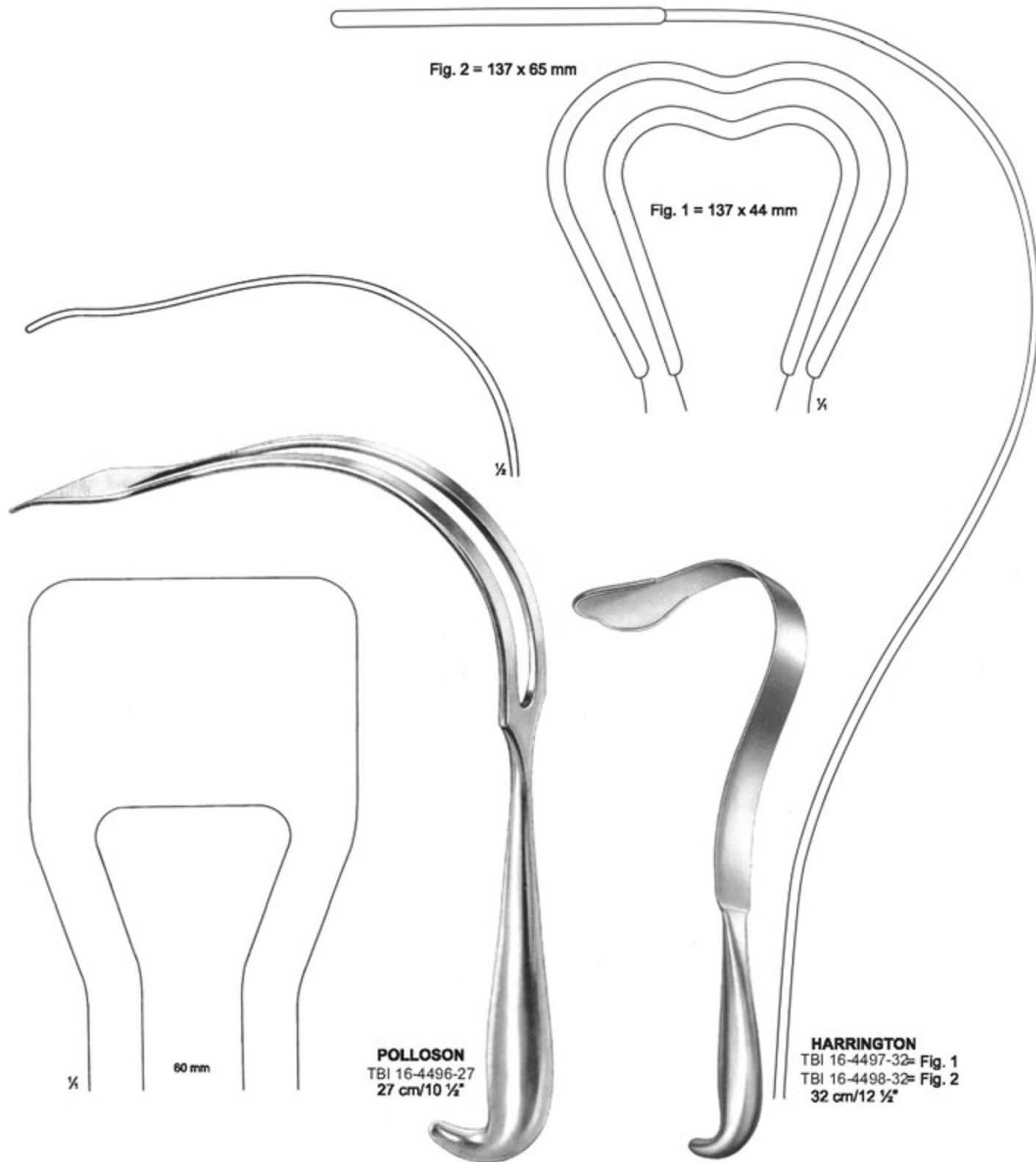

Fig. 2 = 137 x 65 mm

Fig. 1 = 137 x 44 mm

1/4

60 mm

POLLOSON
 TBI 16-4496-27
 27 cm/10 1/2"

HARRINGTON
 TBI 16-4497-32= Fig. 1
 TBI 16-4498-32= Fig. 2
 32 cm/12 1/2"

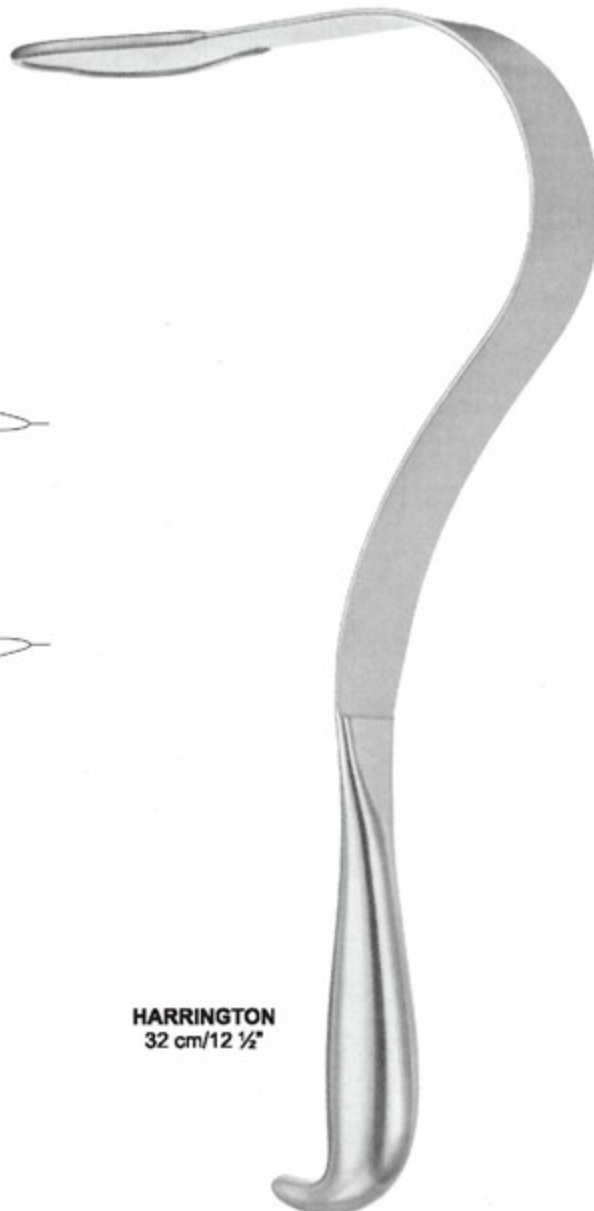
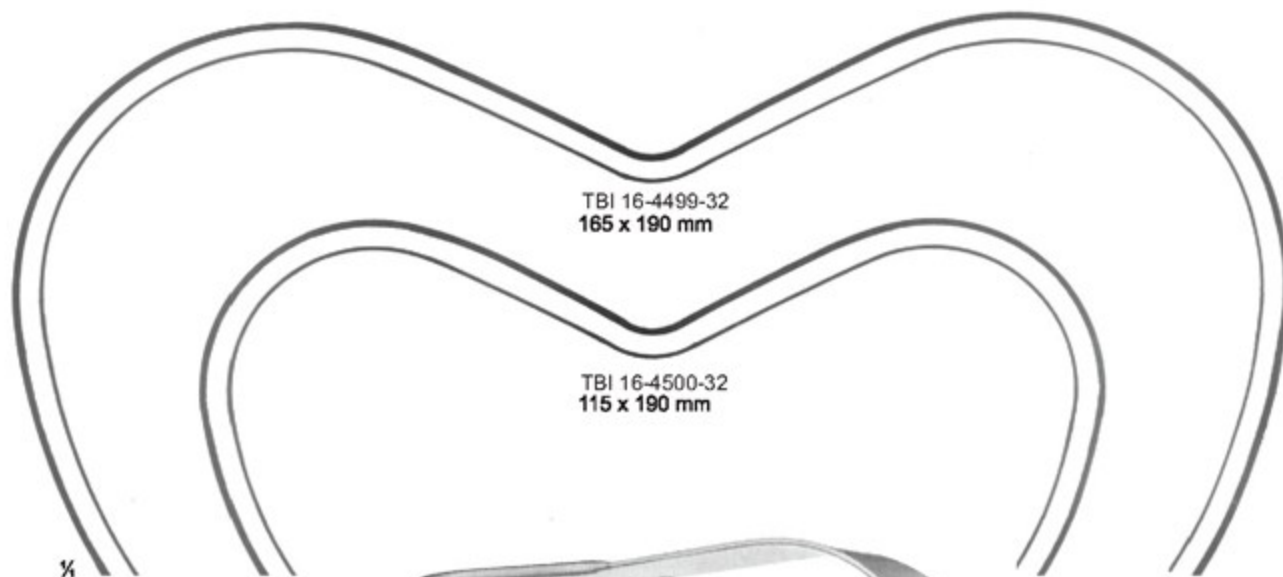

Measurements of retractors: Depth x Width



SAUERBRUCH
22.5 cm/8 7/8"

TBI 16-4502-22
45 x 15 mm

TBI 16-4503-22
60 x 23 mm

TBI 16-4504-22
72 x 20 mm

Measurements of retractors: Depth x Width





DEAVER
TBI 16-4505-18
18 cm/7 1/8"

DEAVER
TBI 16-4506-21
21.5 cm/8 1/2"

DEAVER
TBI 16-4507-21
21.5 cm/8 1/2"

DEAVER
TBI 16-4508-30
30.5 cm/12"

DEAVER
TBI 16-4509-33
33.5 cm/13 1/4"

DEAVER
TBI 16-4510-34
34.5 cm/13 5/8"



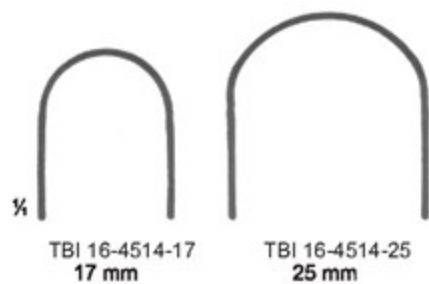

DEAYER-BABY



DEAYER

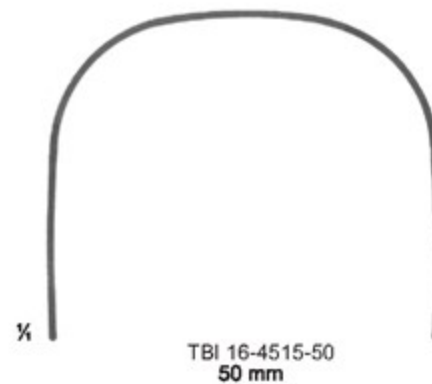
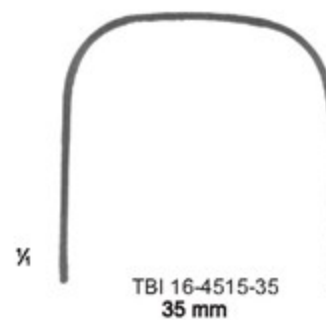
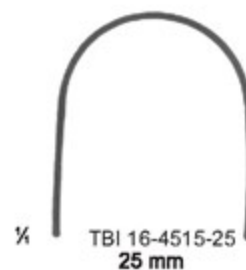



TBI 16-4516-29
 29.5 cm/11 1/2"
 width of blade 48 mm

TBI 16-4516-33
 33 cm/13"
 width of blade 63 mm

ALLISON



TBI 16-4517-29
 29.5 cm/11 1/2"
 width of blade 132 mm

ALLISON

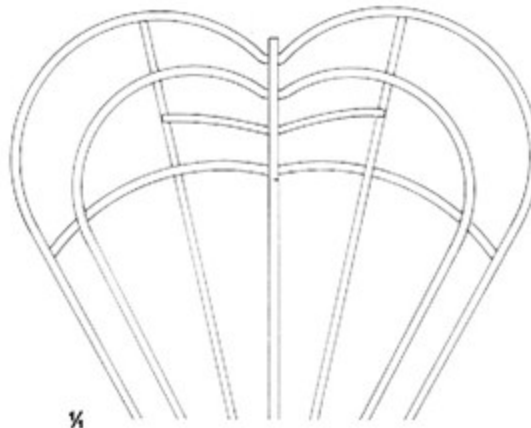

1/4



HIBBS

TBI 16-4518-775 x 25 mm
 TBI 16-4518-560 x 19 mm
 TBI 16-4518-225 x 13 mm

Measurements of retractors: Depth x Width



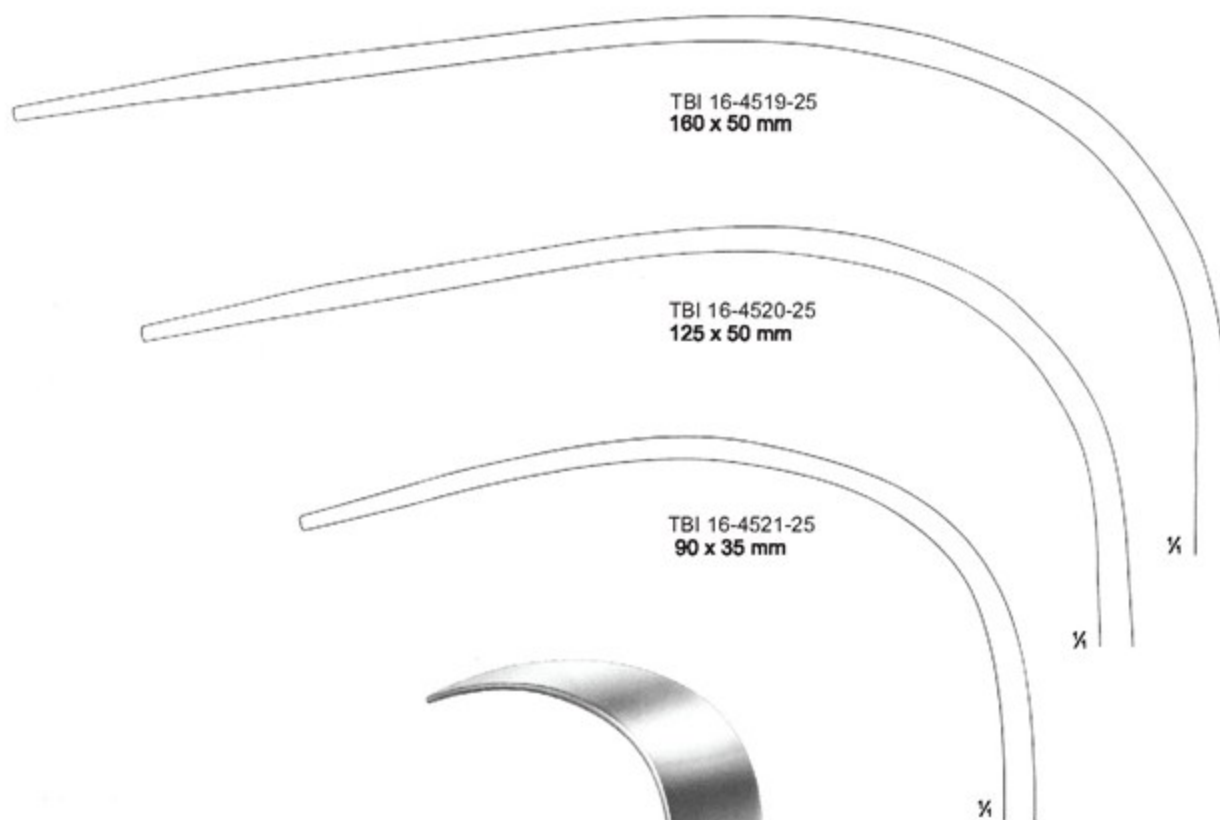

MIKULICZ
25 cm/9 7/8"

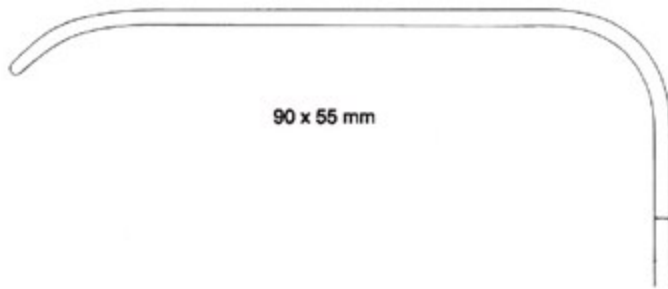

MIKULICZ
 TBI 16-4522-26
 26 cm/10 1/4"

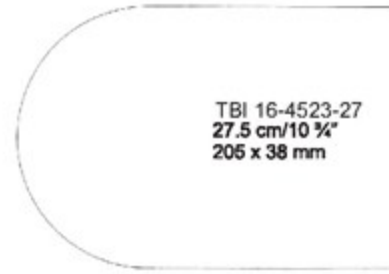

KELLY



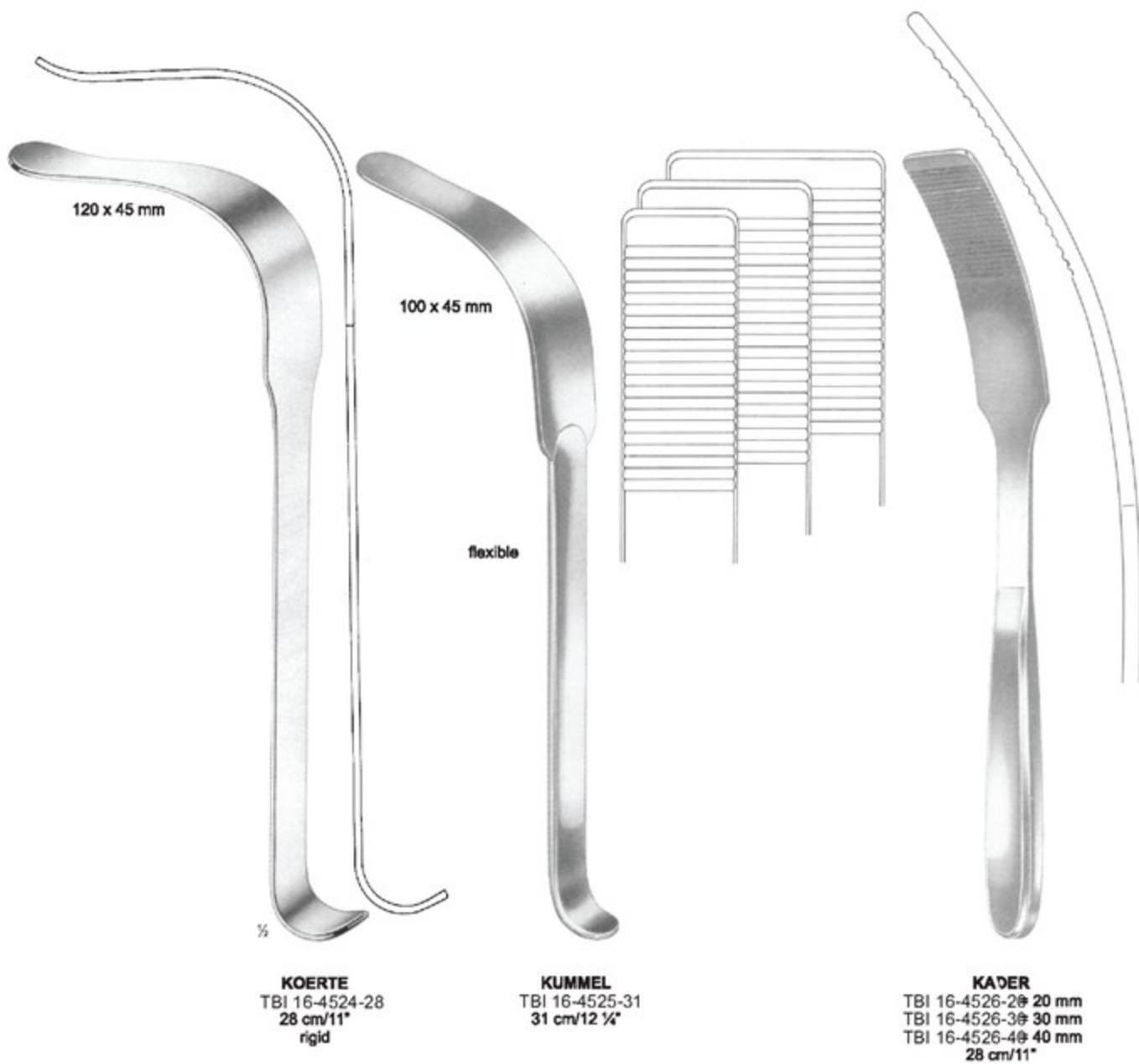

Measurements of Spatulas : Depth x Width

RIBBON SPATULAS



TUFFIER
 20 cm/7 7/8"
 TBI 16-4527-20 17 x 25 mm
 malleable



TBI 16-4528-06 6 x 200 mm
 TBI 16-4528-12 12 x 200 mm
 TBI 16-4528-17 17 x 200 mm
 TBI 16-4528-25 25 x 200 mm
 malleable



TBI 16-4529-27 27 x 250 mm
 TBI 16-4529-35 35 x 250 mm
 malleable



TBI 16-4530-30 30 x 330 mm
 TBI 16-4530-40 40 x 330 mm
 TBI 16-4530-50 50 x 330 mm
 TBI 16-4530-75 75 x 330 mm
 malleable





malleable

HABERER

- TBI 16-4531-20 20 cm/7 7/8" 17 x 25 mm
- TBI 16-4531-28 28 cm/11" 25 x 30 mm
- TBI 16-4531-30 30 cm/11 1/2" 37 x 45 mm



- TBI 16-4532-20 6.5 mm
- TBI 16-4533-20 9.5 mm
- TBI 16-4534-20 13 mm
- TBI 16-4535-20 16 mm
- TBI 16-4536-20 19 mm
- TBI 16-4537-20 25 mm
- 20 cm/7 7/8"



45 mm

REVERDIN

- TBI 16-4538-28 28.5 cm/11 1/4"
- 63 x 45 mm



45 mm

60 mm

1/2"

REVERDIN

- TBI 16-4539-29 29 cm/11 1/2"
- 60 x 45 mm

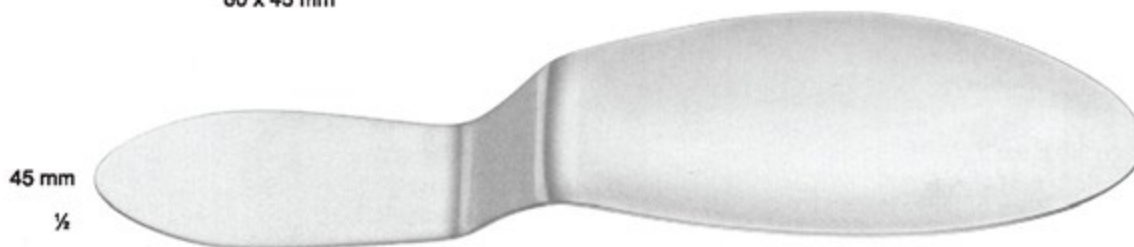

45 mm

60 mm

1/2"

REVERDIN

- TBI 16-4540-28 28 cm/11"
- 60 x 45 mm

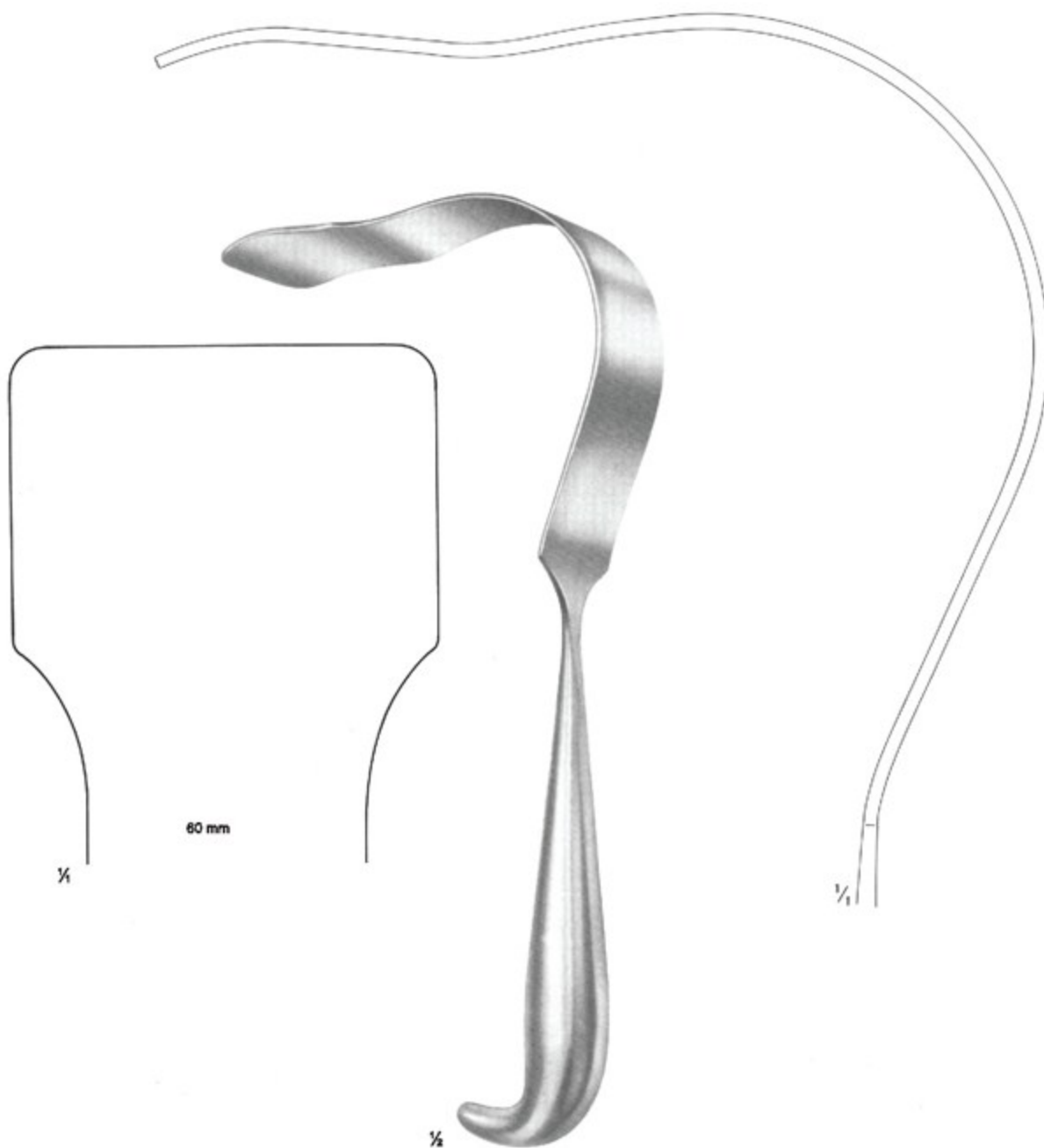

POLLOSON
 TBI 16-4541-29
 29 cm/11 1/4"

Measurements of retractors: Depth x width

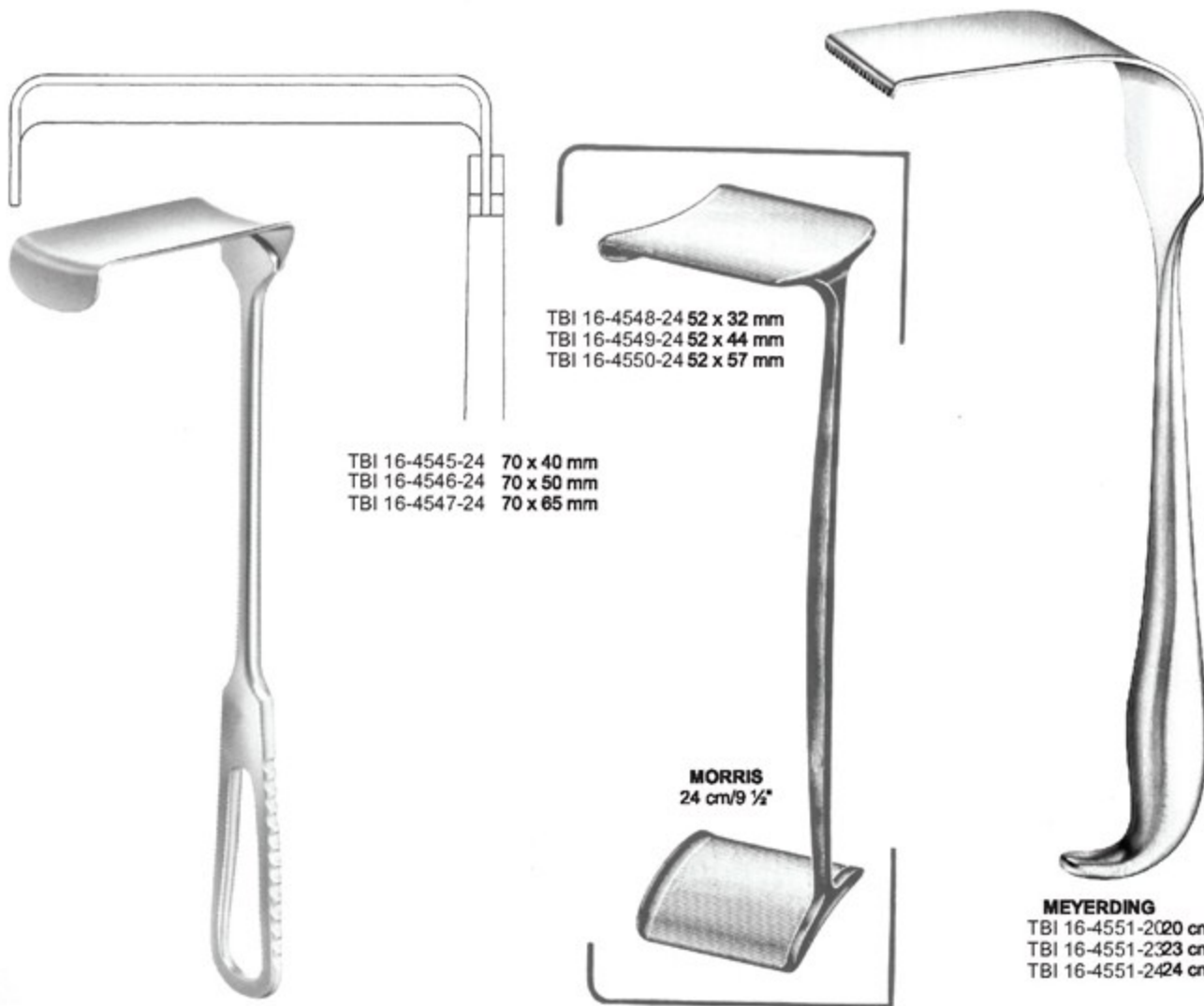
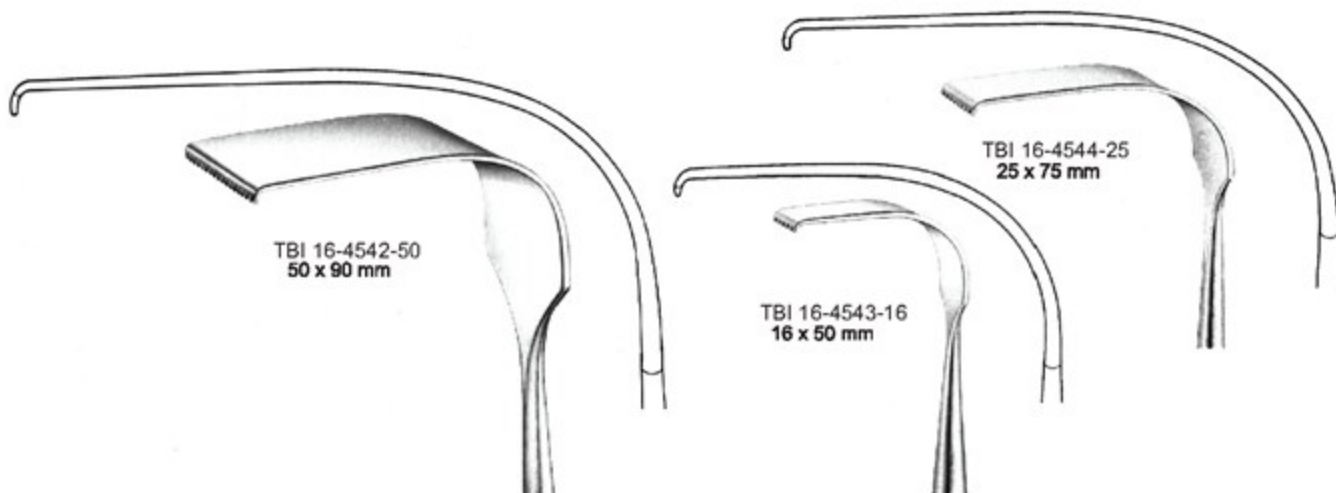

MORRIS
24.5 cm/9 7/8"

TBI 16-4545-24 70 x 40 mm
TBI 16-4546-24 70 x 50 mm
TBI 16-4547-24 70 x 65 mm

MORRIS
24 cm/9 1/2"

MEYERDING
TBI 16-4551-20 20 cm/7 7/8"
TBI 16-4551-23 23 cm/9"
TBI 16-4551-24 24 cm/9 1/2"

Measurements of Spatulas : Depth x Width

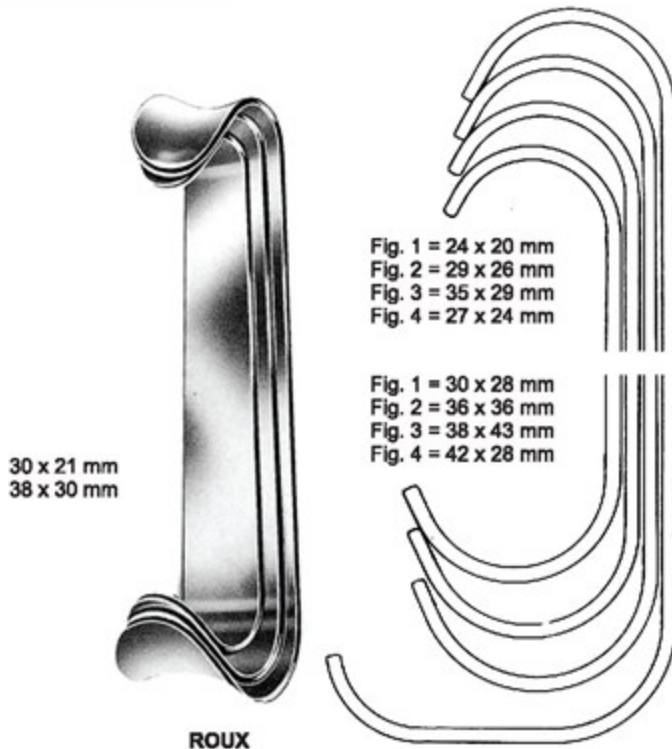

Fig. 1 = 24 x 20 mm
 Fig. 2 = 29 x 26 mm
 Fig. 3 = 35 x 29 mm
 Fig. 4 = 27 x 24 mm

Fig. 1 = 30 x 28 mm
 Fig. 2 = 36 x 36 mm
 Fig. 3 = 38 x 43 mm
 Fig. 4 = 42 x 28 mm

ROUX

- TBI 16-4552-01 Set Fig. 1 - 3
- TBI 16-4552-14 Fig. 1 14 cm/5 1/2"
- TBI 16-4552-15 Fig. 2 15 cm/5 7/8"
- TBI 16-4552-17 Fig. 3 17 cm/6 3/4"
- TBI 16-4552-18 Fig. 4 18 cm/7 1/4"

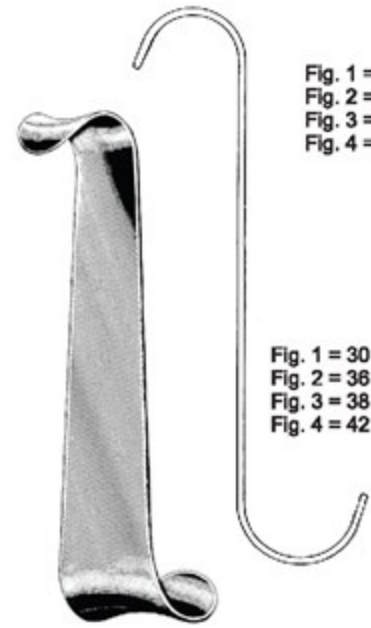

Fig. 1 = 24 x 20 mm
 Fig. 2 = 29 x 26 mm
 Fig. 3 = 35 x 39 mm
 Fig. 4 = 27 x 24 mm

Fig. 1 = 30 x 28 mm
 Fig. 2 = 36 x 36 mm
 Fig. 3 = 38 x 43 mm
 Fig. 4 = 42 x 28 mm

ROUX-MAGNUS

- TBI 16-4553-01 Set Fig. 1 - 3
- TBI 16-4553-14 Fig. 1 14 cm/5 1/2"
- TBI 16-4553-15 Fig. 2 15 cm/5 7/8"
- TBI 16-4553-17 Fig. 3 17 cm/6 3/4"
- TBI 16-4553-18 Fig. 4 18 cm/7 1/4"

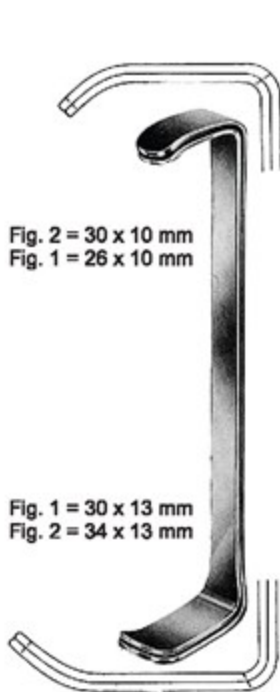

Fig. 2 = 30 x 10 mm
 Fig. 1 = 26 x 10 mm

Fig. 1 = 30 x 13 mm
 Fig. 2 = 34 x 13 mm

FARABEU

- TBI 16-4554-11Set
- TBI 16-4555-11Fig. 1
- TBI 16-4556-11Fig. 2
- 11.5 cm/4 1/2"

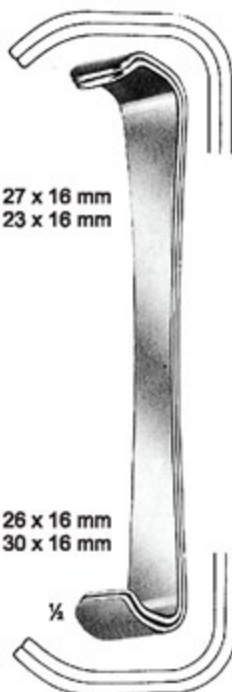
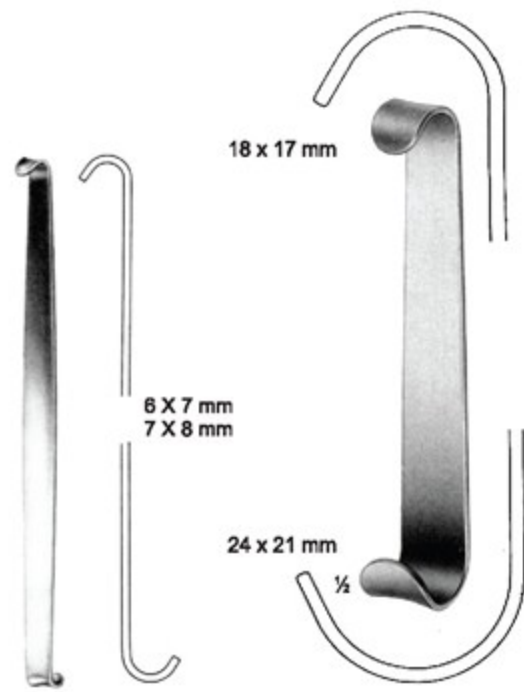

Fig. 2 = 27 x 16 mm
 Fig. 1 = 23 x 16 mm

Fig. 1 = 26 x 16 mm
 Fig. 2 = 30 x 16 mm

FARABEU

- TBI 16-4557-15Set
- TBI 16-4558-15Fig. 1
- TBI 16-4559-15Fig. 2
- 15 cm/5 1/8"



6 X 7 mm
 7 X 8 mm

18 x 17 mm

24 x 21 mm

MINI-ROUX

- TBI 16-4560-14
- 14 cm/5 1/2"

BABY ROUX

- TBI 16-4561-13
- 13 cm/5 1/8"





Fig. 2 = 22 x 15 mm
 Fig. 1 = 19 x 15 mm

Fig. 1 = 19 x 15 mm
 Fig. 2 = 22 x 15 mm

PARKER

TBI 16-4562-13 Set
 TBI 16-4563-13 Fig. 1
 TBI 16-4564-13 Fig. 2
 13.5 cm/5 1/8"



Fig. 2 = 27 x 25 mm
 Fig. 1 = 24 x 25 mm

Fig. 1 = 26 x 25 mm
 Fig. 2 = 29 x 25 mm

PARKER

TBI 16-4565-18 Set
 TBI 16-4566-18 Fig. 1
 TBI 16-4567-18 Fig. 2
 18 cm/7 1/8"



Fig. 2 = 25 x 24 mm
 Fig. 1 = 21 x 24 mm

Fig. 1 = 68 x 24 mm
 Fig. 2 = 72 x 24 mm

PARKER-MOTT

TBI 16-4568-16 Set
 TBI 16-4569-16 Fig. 1
 TBI 16-4570-16 Fig. 2
 16 cm/6 1/8"



Fig. 2 = 47 x 13 mm
 Fig. 1 = 42 x 13 mm

MATHIEU

TBI 16-4571-20 Set
 TBI 16-4572-20 Fig. 1
 TBI 16-4573-20 Fig. 2
 20 cm/7 7/8"

Fig. 1 = 42 x 26 mm
 Fig. 2 = 46 x 26 mm

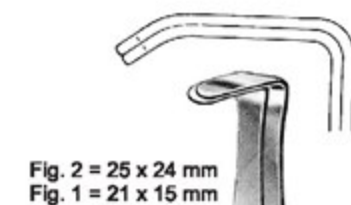

Fig. 2 = 25 x 24 mm
 Fig. 1 = 21 x 15 mm

PARKER-LANGENBECK

TBI 16-4574-21 Set
 TBI 16-4575-21 Fig. 1
 TBI 16-4576-21 Fig. 2
 21 cm/8 1/4"

Fig. 1 = 40 x 15 mm
 Fig. 2 = 45 x 15 mm



40 x 40 mm

GOELET

TBI 16-4577-19
 19 cm/7 1/2"

30 x 30 mm



CRILE
 TBI 16-4578-11
 11 cm/4 3/8"

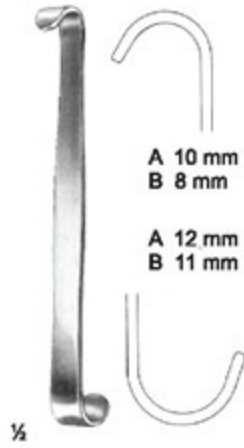

LUER
 TBI 16-4579-11
 11 cm/4 3/8"

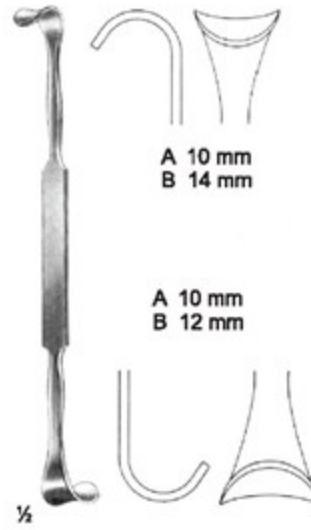

ROSE
 TBI 16-4580-13
 13 cm/5 1/8"



ROSE
 TBI 16-4581-19
 19.5 cm/7 1/2"

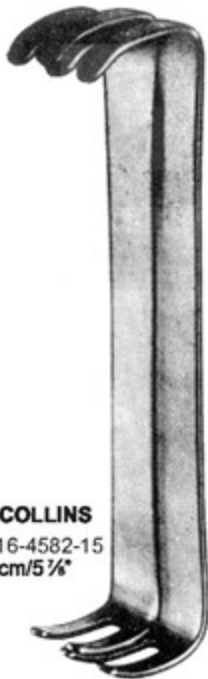

MAYO-COLLINS
 TBI 16-4582-15
 15 cm/5 7/8"

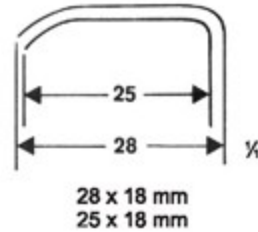

28 x 18 mm
 25 x 18 mm

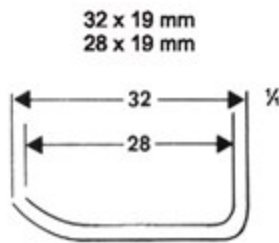

32 x 19 mm
 28 x 19 mm

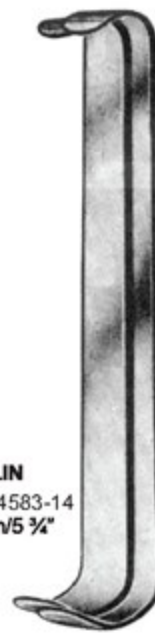

COLLIN
 TBI 16-4583-14
 14.5 cm/5 3/4"

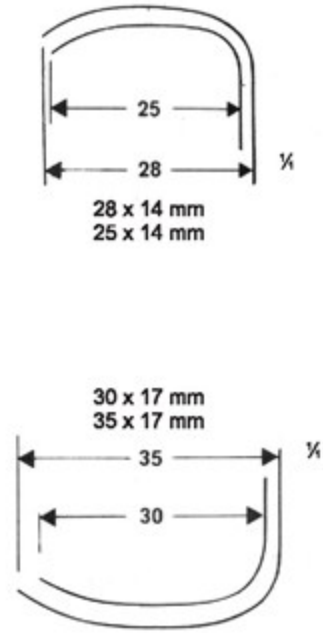

28 x 14 mm
 25 x 14 mm

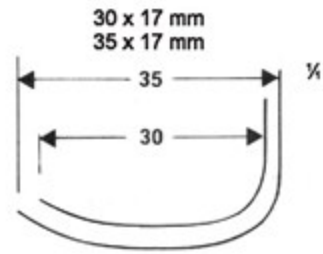

30 x 17 mm
 35 x 17 mm



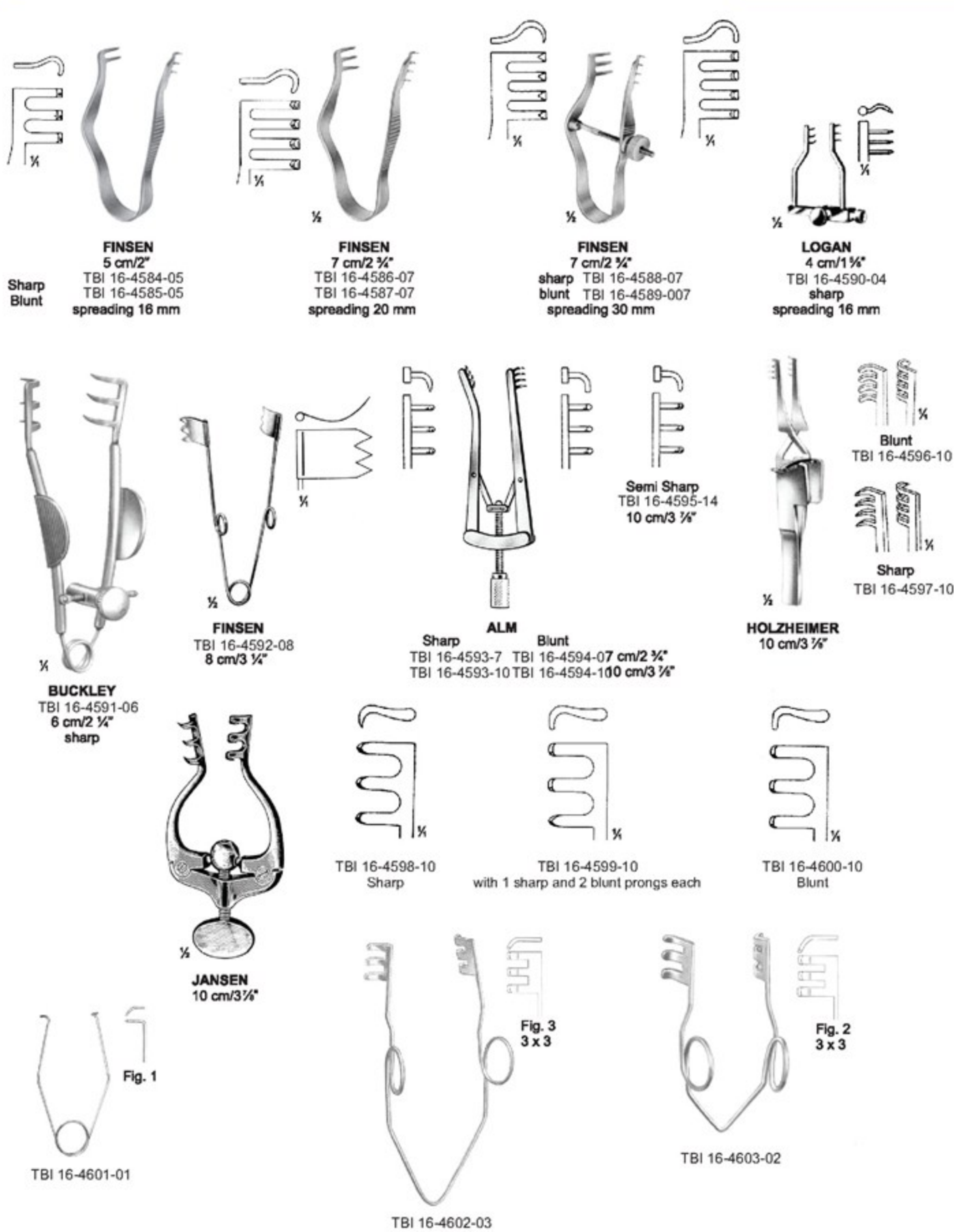

FINSEN
5 cm/2"
TBI 16-4584-05
TBI 16-4585-05
Sharp
Blunt
spreading 16 mm

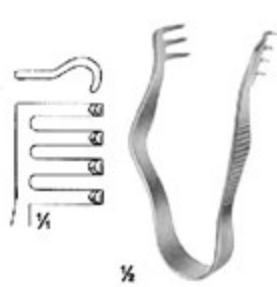

FINSEN
7 cm/2 1/2"
TBI 16-4586-07
TBI 16-4587-07
sharp
blunt
spreading 20 mm

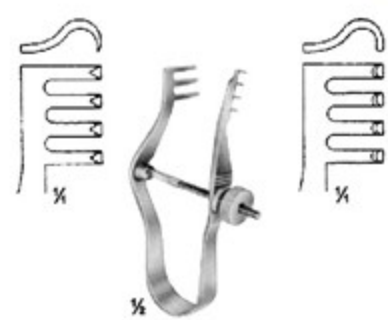

FINSEN
7 cm/2 1/2"
sharp TBI 16-4588-07
blunt TBI 16-4589-007
spreading 30 mm



LOGAN
4 cm/1 1/2"
TBI 16-4590-04
sharp
spreading 16 mm



BUCKLEY
TBI 16-4591-06
6 cm/2 1/4"
sharp

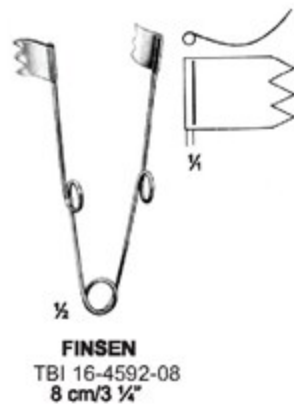

FINSEN
TBI 16-4592-08
8 cm/3 1/4"

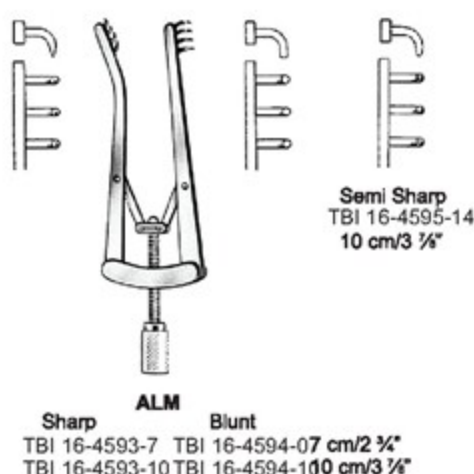

ALM
Sharp TBI 16-4593-7
Blunt TBI 16-4594-07
TBI 16-4593-10 TBI 16-4594-100
10 cm/3 1/4"

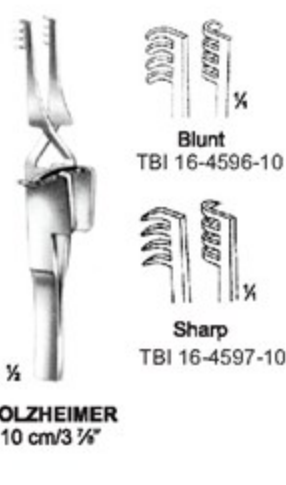

HOLZHEIMER
10 cm/3 1/2"
Blunt TBI 16-4596-10
Sharp TBI 16-4597-10



JANSEN
10 cm/3 1/4"



TBI 16-4598-10
Sharp



TBI 16-4599-10
with 1 sharp and 2 blunt prongs each



TBI 16-4600-10
Blunt

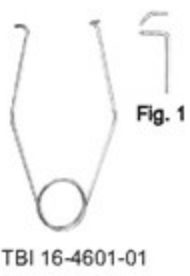

TBI 16-4601-01
Fig. 1

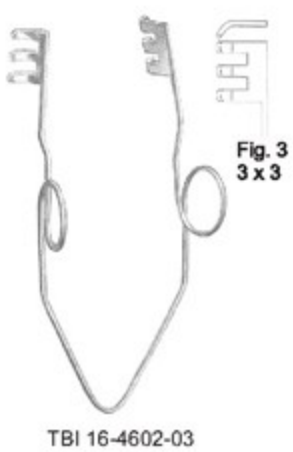

TBI 16-4602-03
Fig. 3
3 x 3



TBI 16-4603-02
Fig. 2
3 x 3



WEITLANER
2:2

TBI 16-4604-13sharp
TBI 16-4605-13blunt
13.5 cm/5 1/4"



WEITLANER
2:2

TBI 16-4606-13semi sharp
13.5 cm/5 1/4"



WEITLANER
2:3

TBI 16-4607-10sharp
TBI 16-4608-10blunt
10.5 cm/4 1/8"

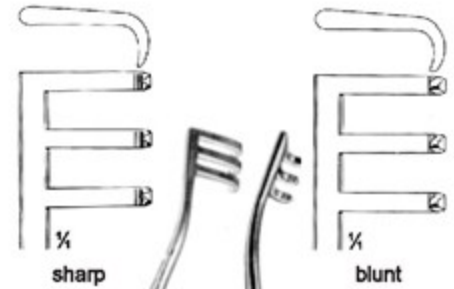

WEITLANER
3:4

TBI 16-4609-133 cm/5 1/8" sharp
TBI 16-4610-133 cm/5 1/8" blunt
TBI 16-4611-106.5 cm/6 1/2" sharp
TBI 16-4512-106.5 cm/6 1/2" blunt

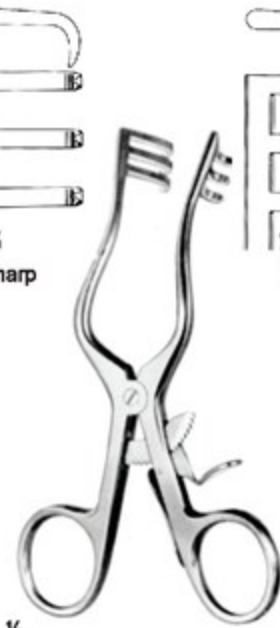

WEITLANER-WULLSTEIN
3:3

TBI 16-4613-13sharp
TBI 16-4614-13blunt
13 cm/5 1/8"

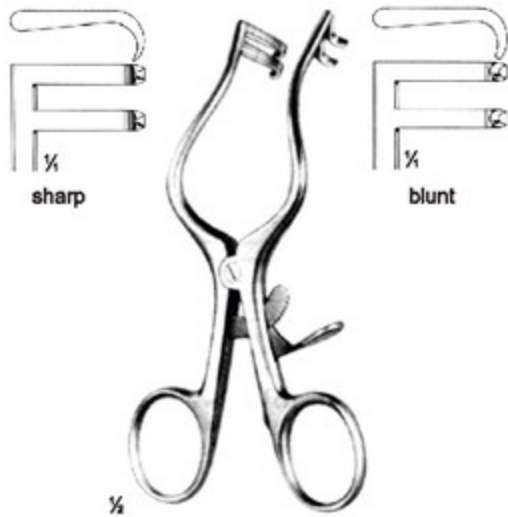

PLESTER

TBI 16-4615-13sharp
TBI 16-4616-13blunt
13 cm/5 1/8"



PLESTER
Blunt

TBI 16-4617-10
10.5 cm/4 1/8"



PLESTER
Blunt

TBI 16-4618-10
10.5 cm/4 1/8"

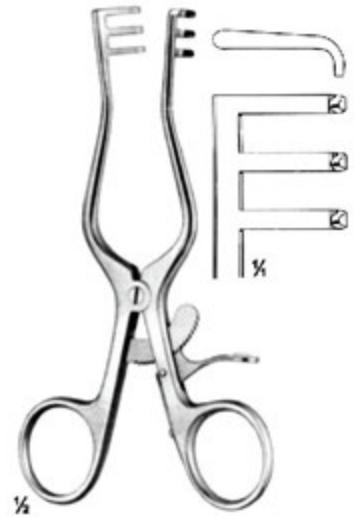

MILLIGAN
Blunt

TBI 16-4619-13
13.5 cm/5 1/8"

Measurements of Retractors : Depth x Width



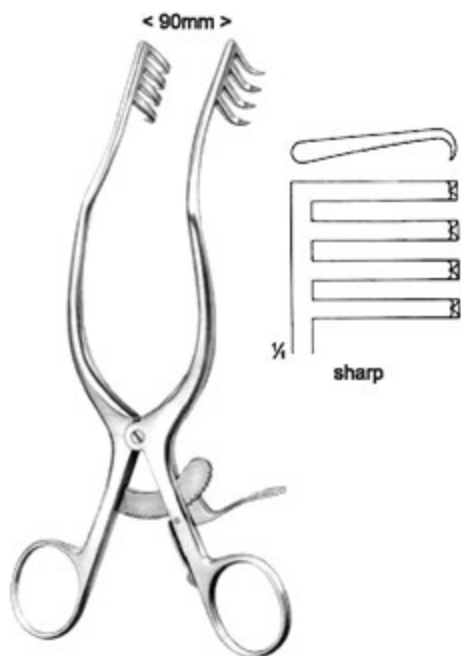

ANDERSON - ADSON
4 : 4
TBI 16-4620-19
19 cm / 7 1/2"



WEITLANER
3 : 4

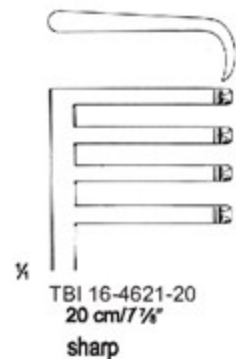

TBI 16-4621-20
20 cm / 7 7/8"

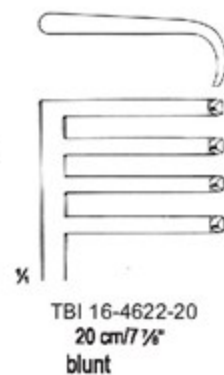

TBI 16-4622-20
20 cm / 7 7/8"

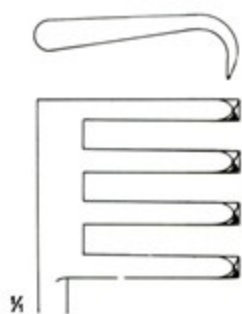

TBI 16-4623-26
26 cm / 10 1/4"

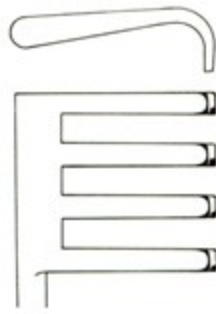

TBI 16-4624-26
26 cm / 10 1/4"

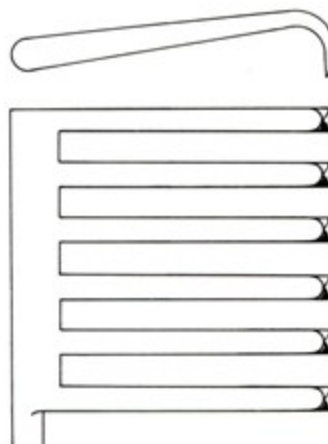

TBI 16-4625-29
29 cm / 11 1/2"

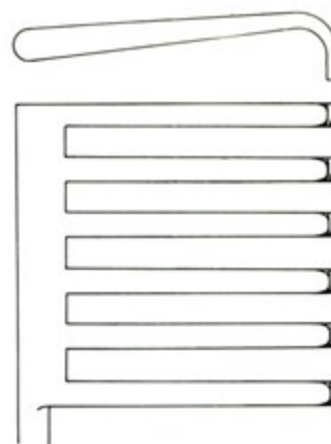

TBI 16-4626-29
29 cm / 11 1/2"

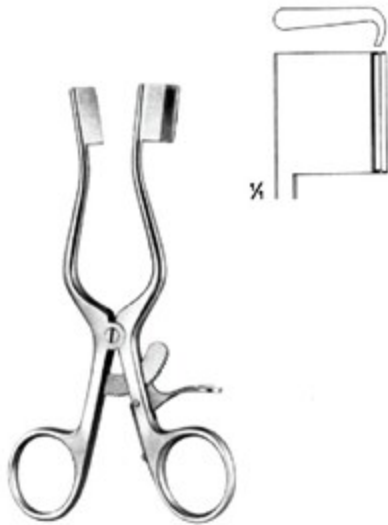

WEITLANER-BABY
 TBI 16-4627-13
 13.5 cm/5 1/4"

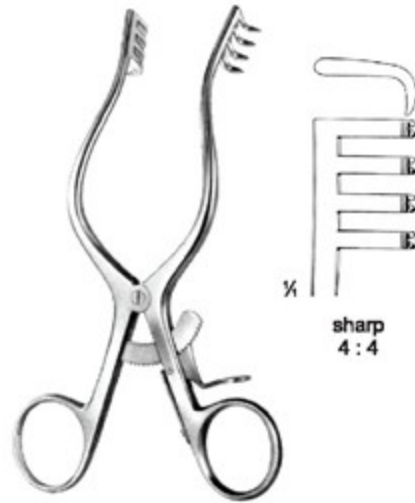

MOLLISON
 TBI 16-4628-15
 15.5 cm/6 1/8"

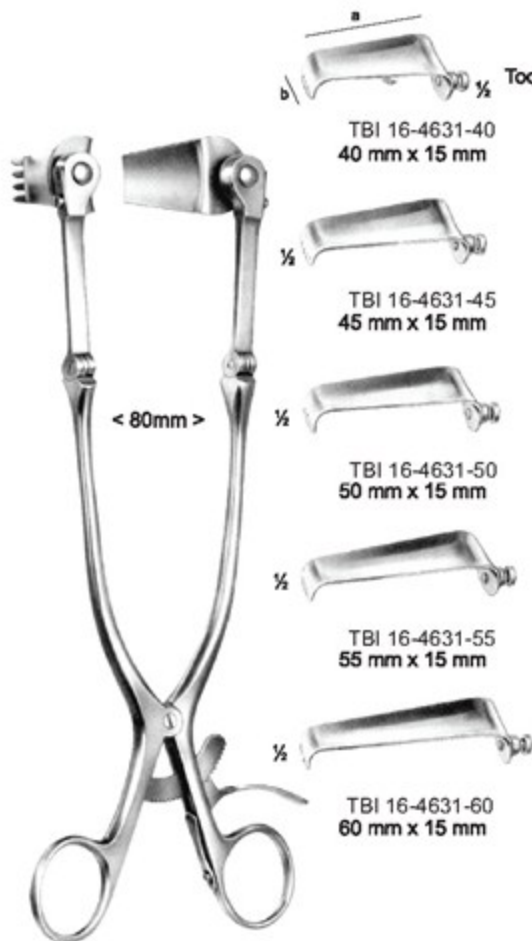

CLOWARD
 TBI 16-4629-25 Retractor complete (with 2 blades ea.)
 TBI 16-4630-25 Retractor only
 25 cm/9 1/2"

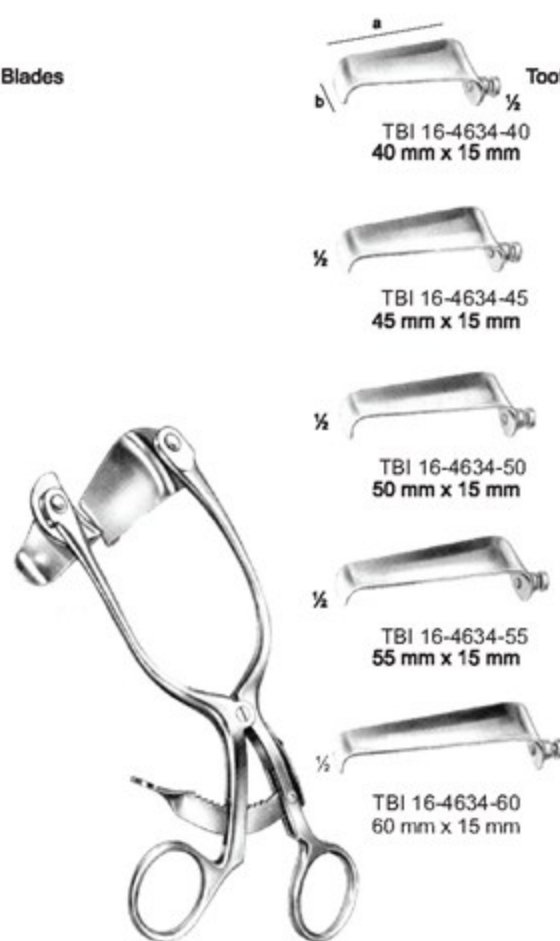

CLOWARD
 TBI 16-4632-16 Retractor complete (with 2 blades ea.)
 TBI 16-4633-16 Retractor only
 16 cm/6 1/4"





sharp

blunt



TBI 16-4635-13
13.5 cm/5 1/2"
3 : 4

TBI 16-4636-13
13.5 cm/5 1/2"
3 : 4



TBI 16-4637-16
16.5 cm/6 1/2"
3 : 4

TBI 16-4638-16
16.5 cm/6 1/2"
3 : 4

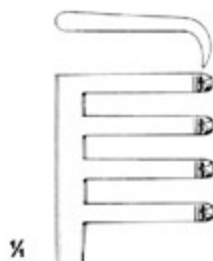

TBI 16-4639-21
21 cm/8 1/4"
3 : 4

TBI 16-4640-21
21 cm/8 1/4"
3 : 4

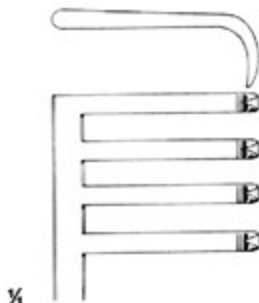

TBI 16-4641-24
24.5 cm/9 1/2"
3 : 4

TBI 16-4642-24
24.5 cm/9 1/2"
3 : 4

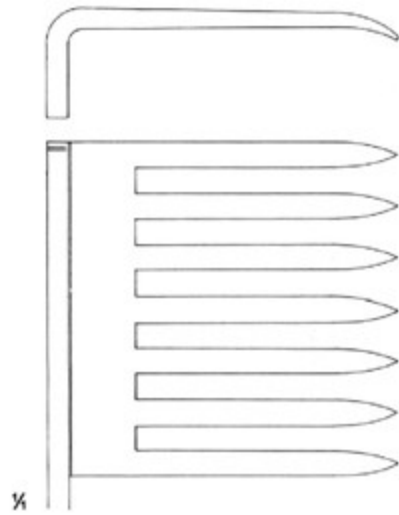
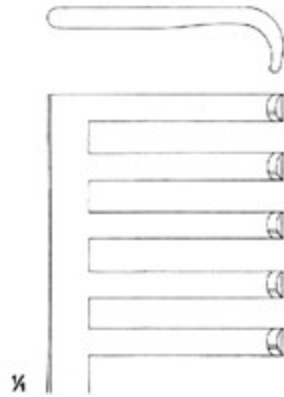
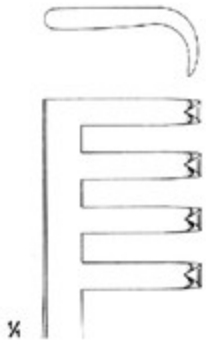

BECKMANN
 TBI 16-4643-31
 31 cm/12 1/2"
 4 : 4
 sharp



ADSON
 TBI 16-4644-32
 32 cm/12 1/2"
 4 : 5
 blunt



BECKMANN-EATON
 TBI 16-4645-32
 32 cm/12 1/2"
 7 : 7
 Sharp

Measurements of retractors: Depth x Width





1/2

BECKMAN-ADSON
30.5 cm/12"
4 : 4

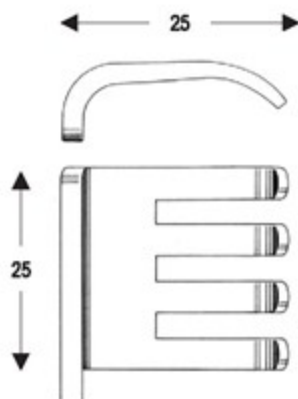

TBI 16-4646-30
blunt

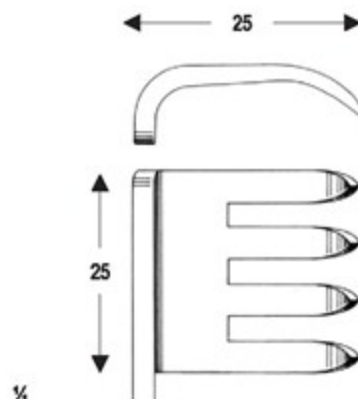

1/2

TBI 16-4647-30
sharp

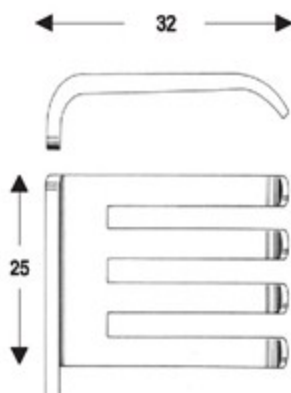

TBI 16-4648-30
blunt

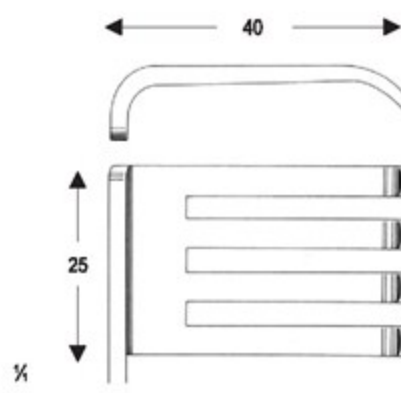

1/2

TBI 16-4649-30
blunt

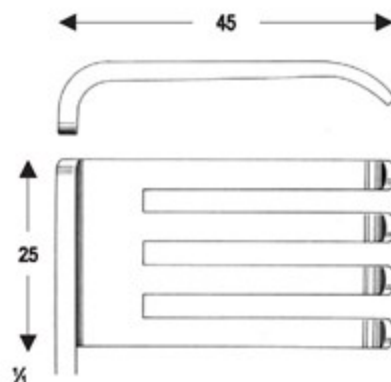

1/2

TBI 16-4650-30
blunt



28.5 cm/11 1/4"
6 : 6

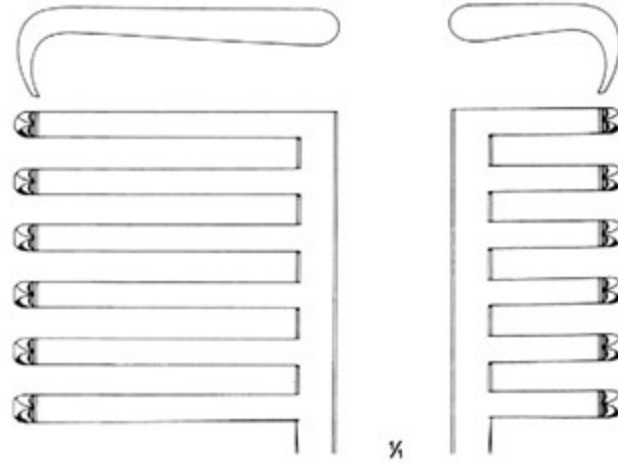

TBI 16-4651-28
Sharp, long teeth on left side

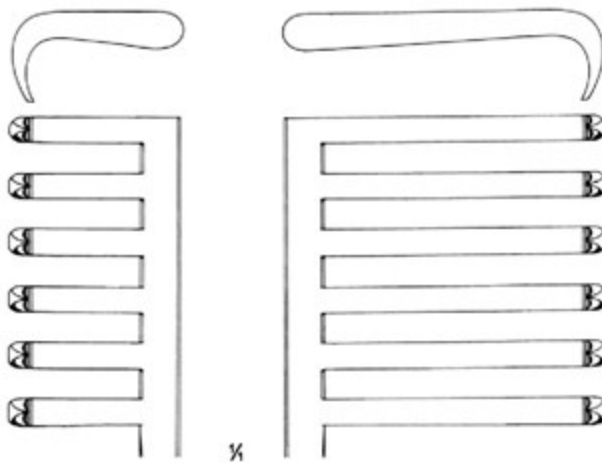

TBI 16-4652-28
Sharp, long teeth on right side





MEYERDING
19 cm / 7 1/2"

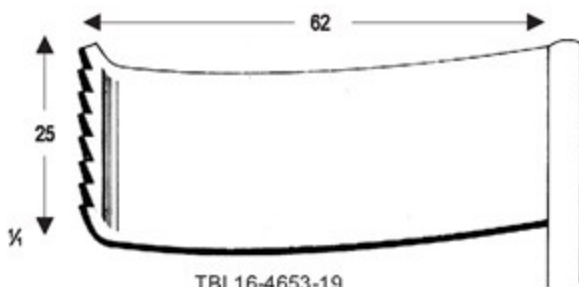

TBI 16-4653-19

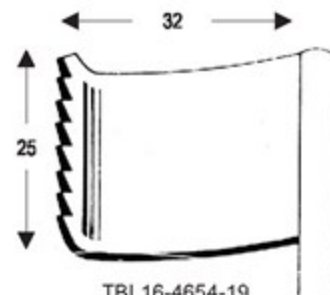

TBI 16-4654-19

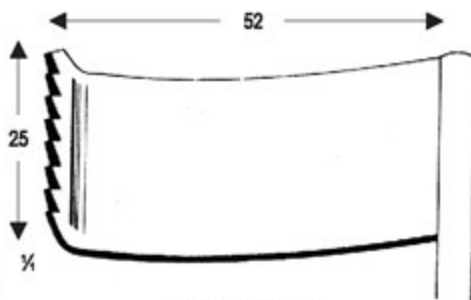

TBI 16-4655-19

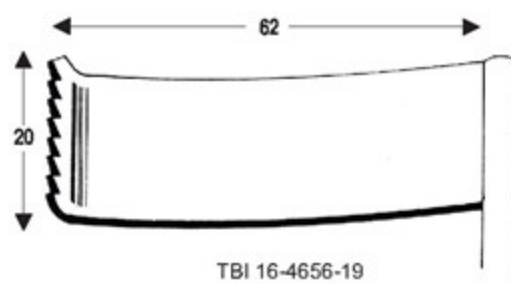

TBI 16-4656-19

Measurements of retractors: Depth x Width

Lateral Blade
 25 x 50 mm



½

MARKHAM-MEYERDING
 TBI 16-4657-18
 18 cm/7 ¼"

Lateral Blade
 25 x 50 mm



½

MARKHAM-MEYERDING
 TBI 16-4658-18
 18 cm/7 ¼"



½

HENLEY
 16 cm/6 ¼"



TBI 16-4659-16
 19 x 16 mm



TBI 16-4660-16
 25 x 16 mm



TBI 16-4661-16
 32 x 16 mm

Measurements of retractors: Depth x Width





GELPI

- TBI 16-4662-09 9 cm/3 1/2"
- TBI 16-4662-11 11 cm/4 1/4"
- TBI 16-4662-13 13 cm/5 1/8"
- TBI 16-4662-14 14 cm/5 1/2"
- TBI 16-4662-16 16 cm/6 1/4"
- TBI 16-4662-18 18 cm/7 1/8"



GELPI-LOKTITE

- TBI 16-4663-09 9 cm/3 1/2"
- TBI 16-4663-11 11 cm/4 1/4"
- TBI 16-4663-13 13 cm/5 1/8"
- TBI 16-4663-14 14 cm/5 1/2"
- TBI 16-4663-16 16 cm/6 1/4"
- TBI 16-4663-18 18 cm/7 1/8"

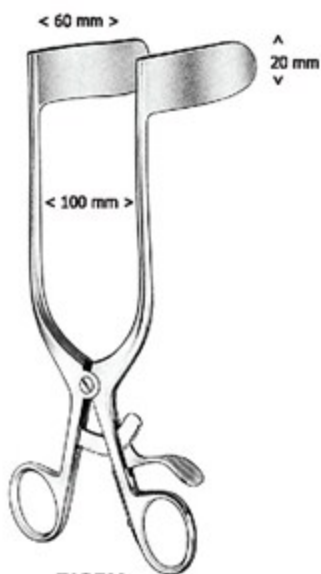

RIGBY
TBI 16-4664-19
(Rectum, Vagina)
19 cm/7 1/2"



TBI 16-4665-18
18 cm/7 1/8"



MAYO-ADAMS
 TBI 16-4666-16
 16.5 cm/6 1/2"

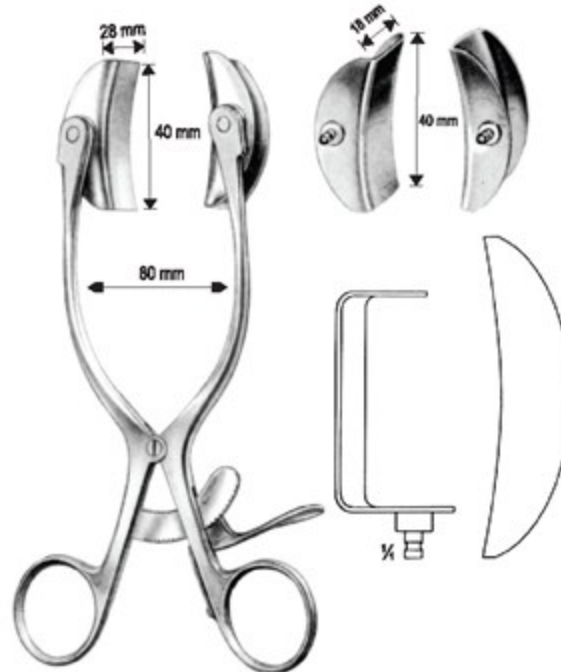

BABY-COLLIN complete, with 2 pairs of exchangeable blades
 TBI 16-4667-00



COLLIN
 TBI 16-4668-38



Measurements see below

Exchangeable Blades

COLLIN
 TBI 16-4669-38 Lateral Blades 38 x 60 mm / Central Blades 38 x 55 mm
 TBI 16-4670-38 Lateral Blades 38 x 80mm / Central Blades 50 x 75mm

Measurements of retractors: Depth x Width



Exchangeable Blades



COLLIN-LOCKTITE
TBI 16-4671-31
31 cm 12 1/4"

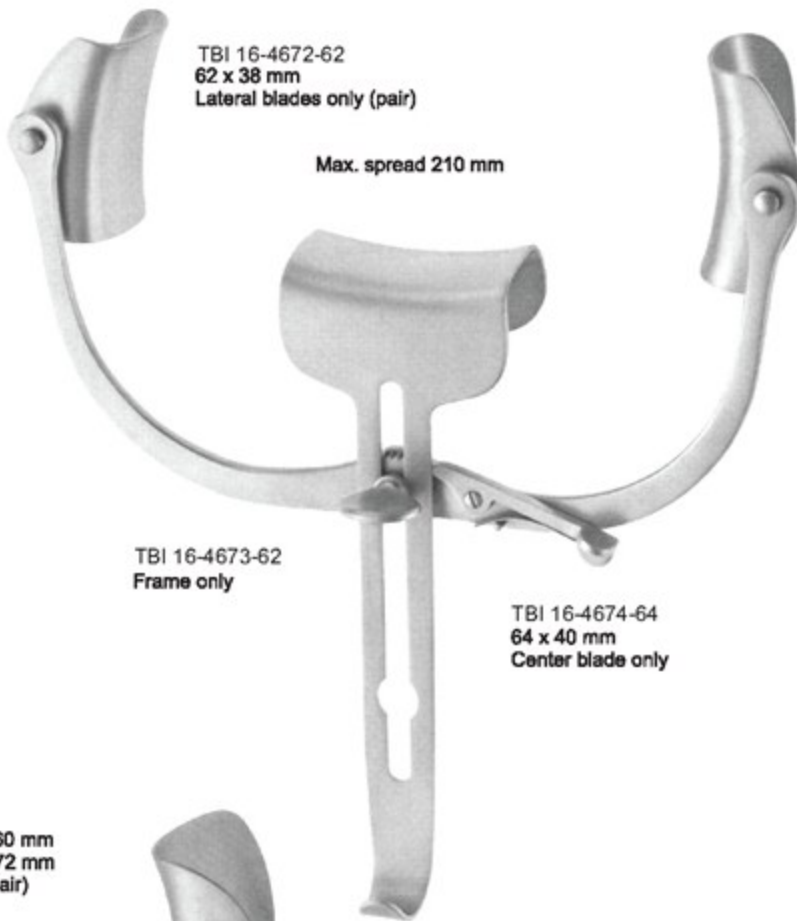

TBI 16-4672-62
62 x 38 mm
Lateral blades only (pair)

Max. spread 210 mm

TBI 16-4673-62
Frame only

TBI 16-4674-64
64 x 40 mm
Center blade only

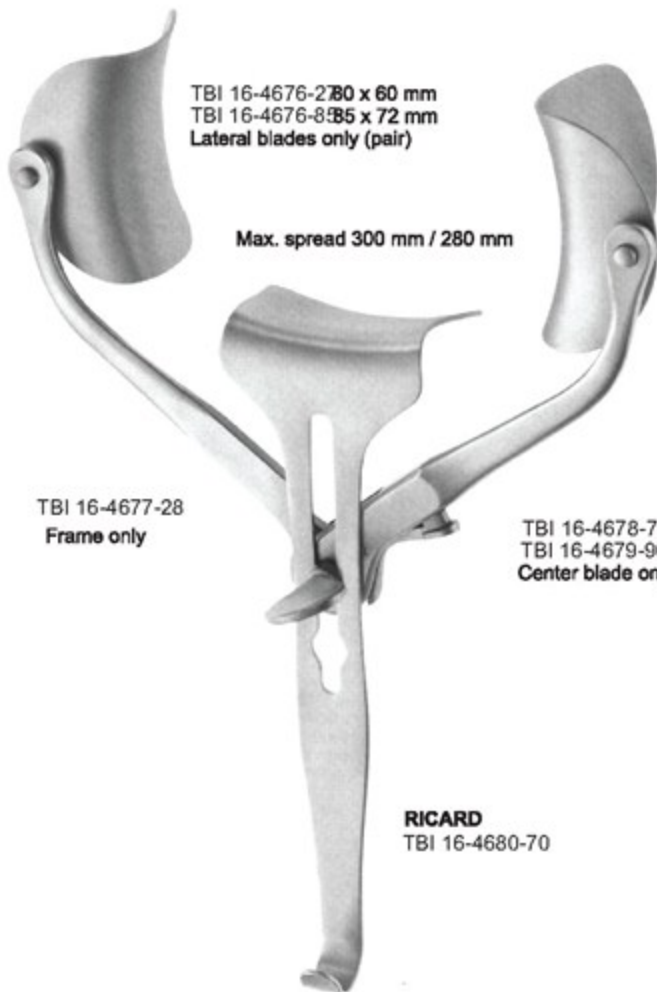

TBI 16-4676-280 x 60 mm
TBI 16-4676-85 x 72 mm
Lateral blades only (pair)

Max. spread 300 mm / 280 mm

TBI 16-4677-28
Frame only

TBI 16-4678-70 x 55 mm
TBI 16-4679-80 x 80 mm
Center blade only

RICARD
TBI 16-4680-70

ROBIN-MASSE
TBI 16-4675-64

Measurements of retractors: Depth x Width



BALFOUR
 TBI 16-4681-20
 20 cm/7 7/8"

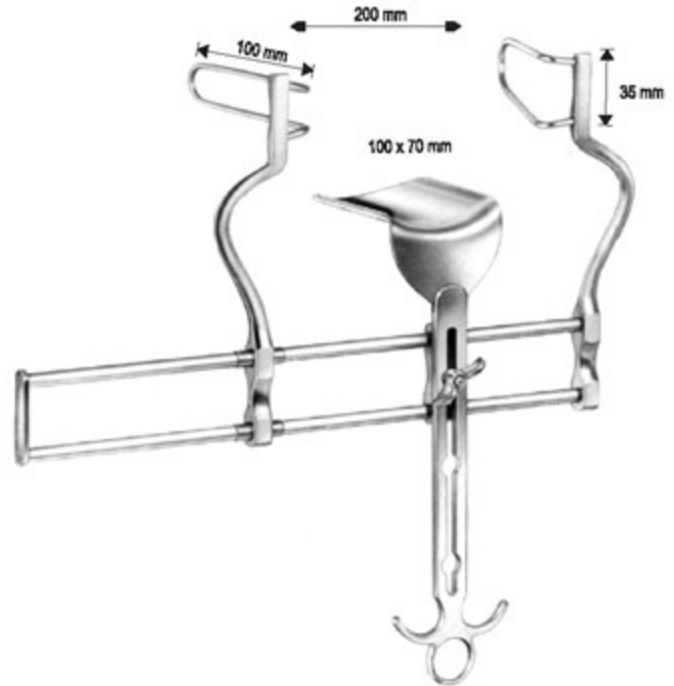

BALFOUR
 TBI 16-4682-20

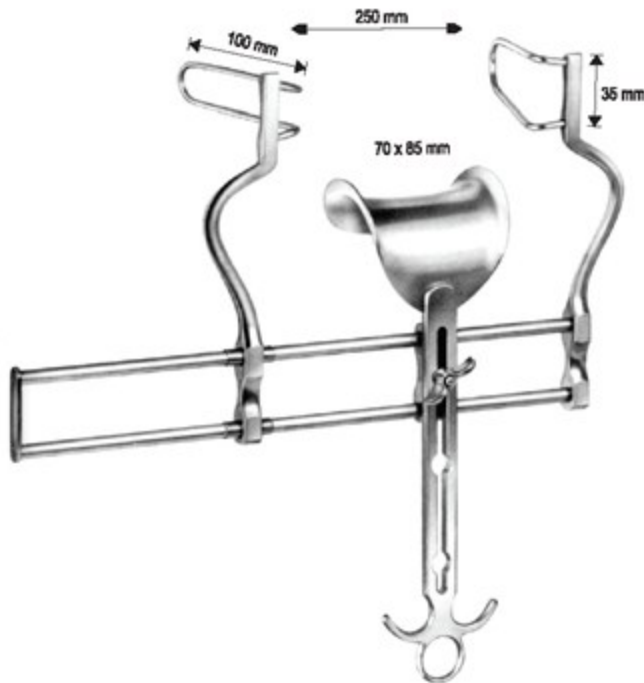

BALFOUR
 TBI 16-4683-00

Centre Blade only



BALFOUR
 TBI 16-4684-45= 45 X 80 mm
 TBI 16-4684-70= 70 X 85 mm
 TBI 16-4684-80= 80 X 90 mm

Measurements of retractors: Depth x Width





GOSSET-BABY
TBI 16-4685-12
12.5 cm/4 1/4"

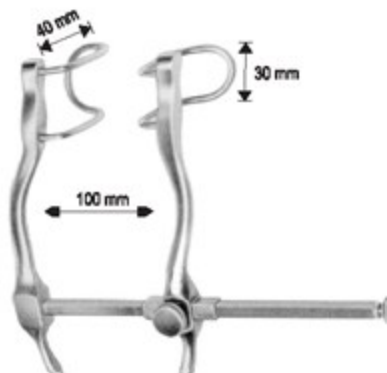

GOSSET
TBI 16-4686-12

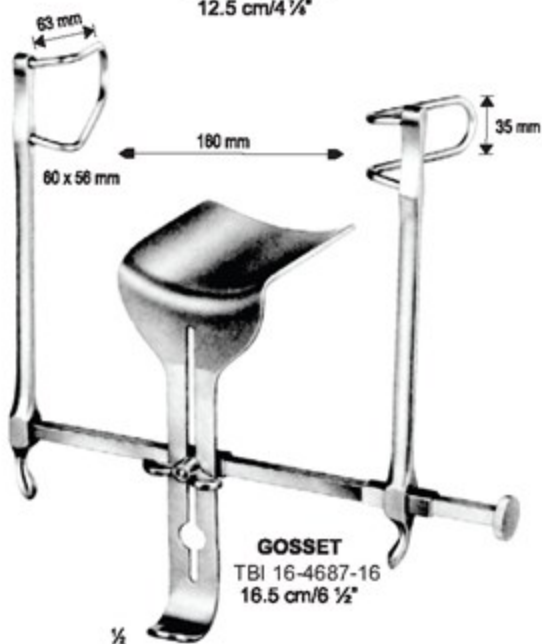

GOSSET
TBI 16-4687-16
16.5 cm/6 1/2"

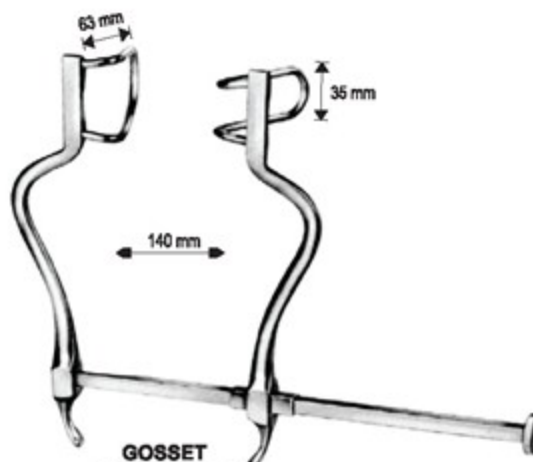

GOSSET
TBI 16-4688-18
18.5 cm/7 1/4"



BALFOUR-BABY
TBI 16-4689-12
12.5 cm/4 1/4"

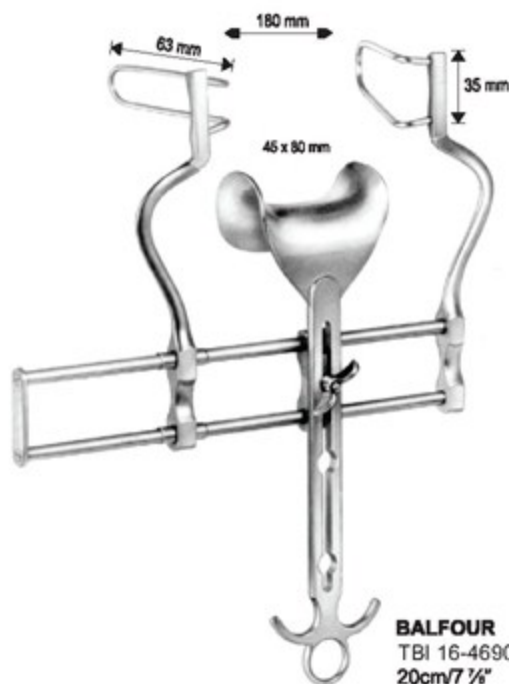

BALFOUR
TBI 16-4690-20
20 cm/7 1/2"

Measurements of retractors: Depth x Width

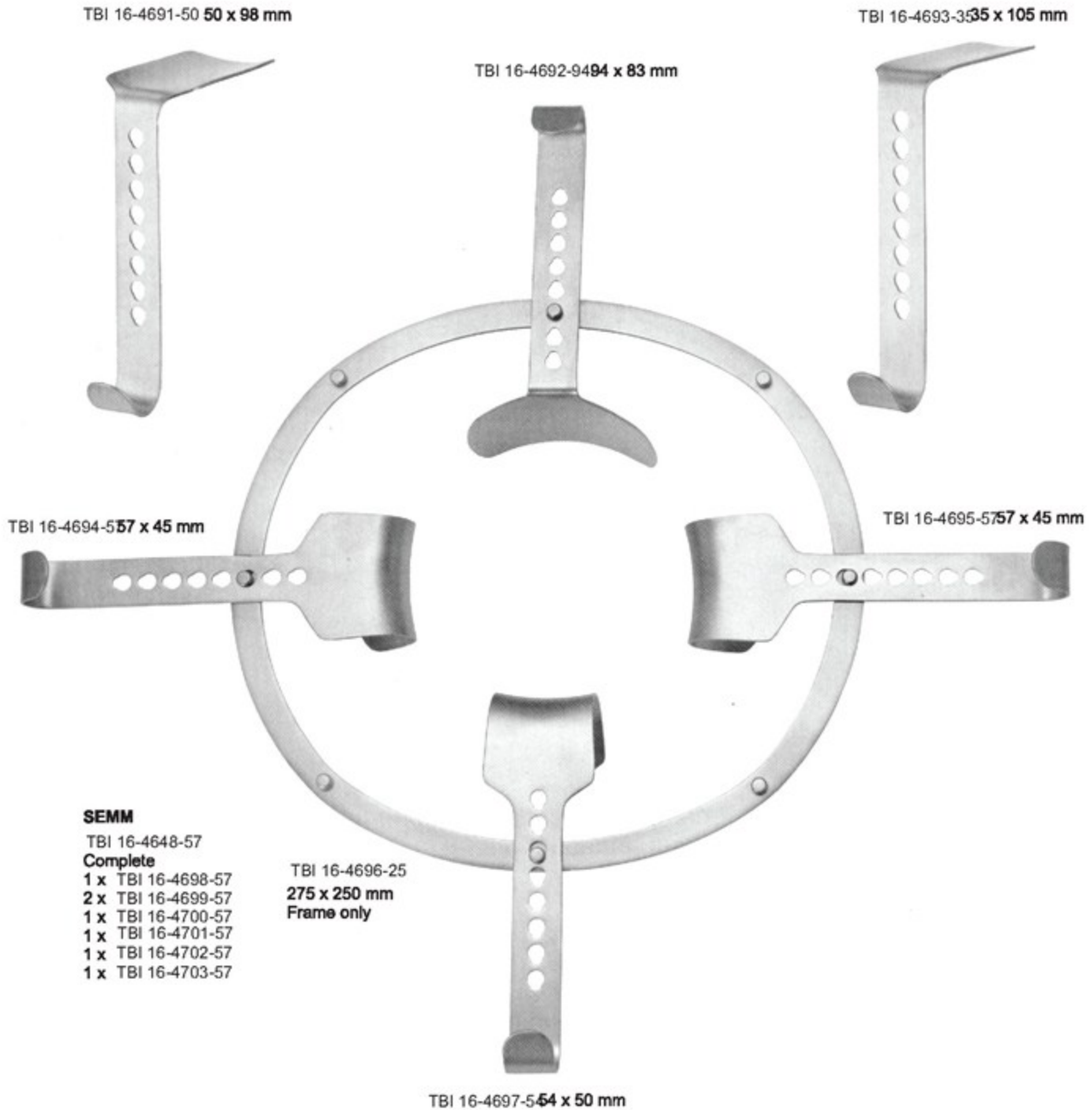

SEMM
 TBI 16-4648-57
Complete
 1 x TBI 16-4698-57
 2 x TBI 16-4699-57
 1 x TBI 16-4700-57
 1 x TBI 16-4701-57
 1 x TBI 16-4702-57
 1 x TBI 16-4703-57

TBI 16-4696-25
 275 x 250 mm
 Frame only

Measurements of retractors: Depth x Width

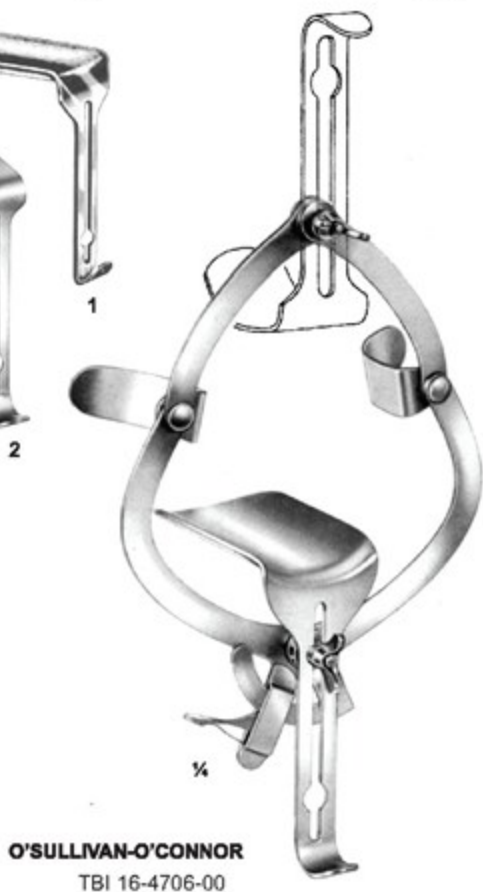
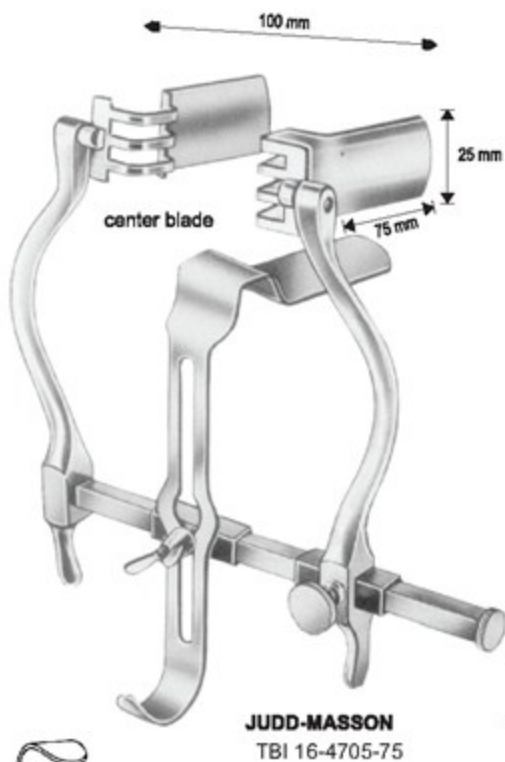
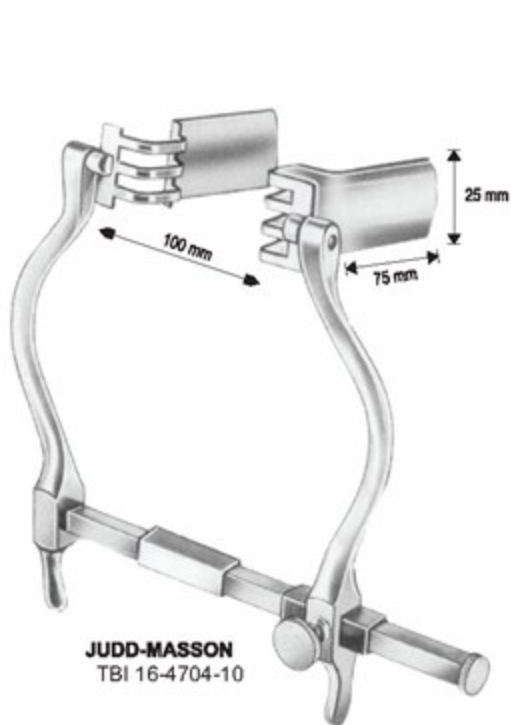

DOYEN
TBI 16-4707-5555 x 95 mm
TBI 16-4708-5555 x 105 mm
TBI 16-4709-5555 x 115 mm
TBI 16-4710-5555 x 125 mm

Measurements of retractors: Depth x Width



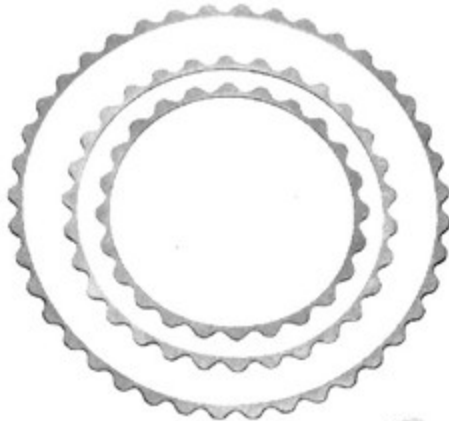

TURNER-WARWICK
 Retractor frame, round
 TBI 16-4711-1 Ø 18 cm/7 1/4"
 TBI 16-4711-2 Ø 23 cm/9"
 TBI 16-4711-3 Ø 30.5 cm/12"



TURNER-WARWICK
 TBI 16-4712-33
 Retractor frame, oval
 457 x 330 mm



TURNER-WARWICK
 TBI 16-4713-33
 Abdominal retractor, complete
 consisting of
 1 frame TBI 16-4714-33
 2 retractor blades of each TBI 16-4715-33
 2 abdominal retractor of each TBI 16-4716-33
 2 abdominal retractor of each TBI 16-4717-33
 2 retractor blade single hooks TBI 16-4718-33

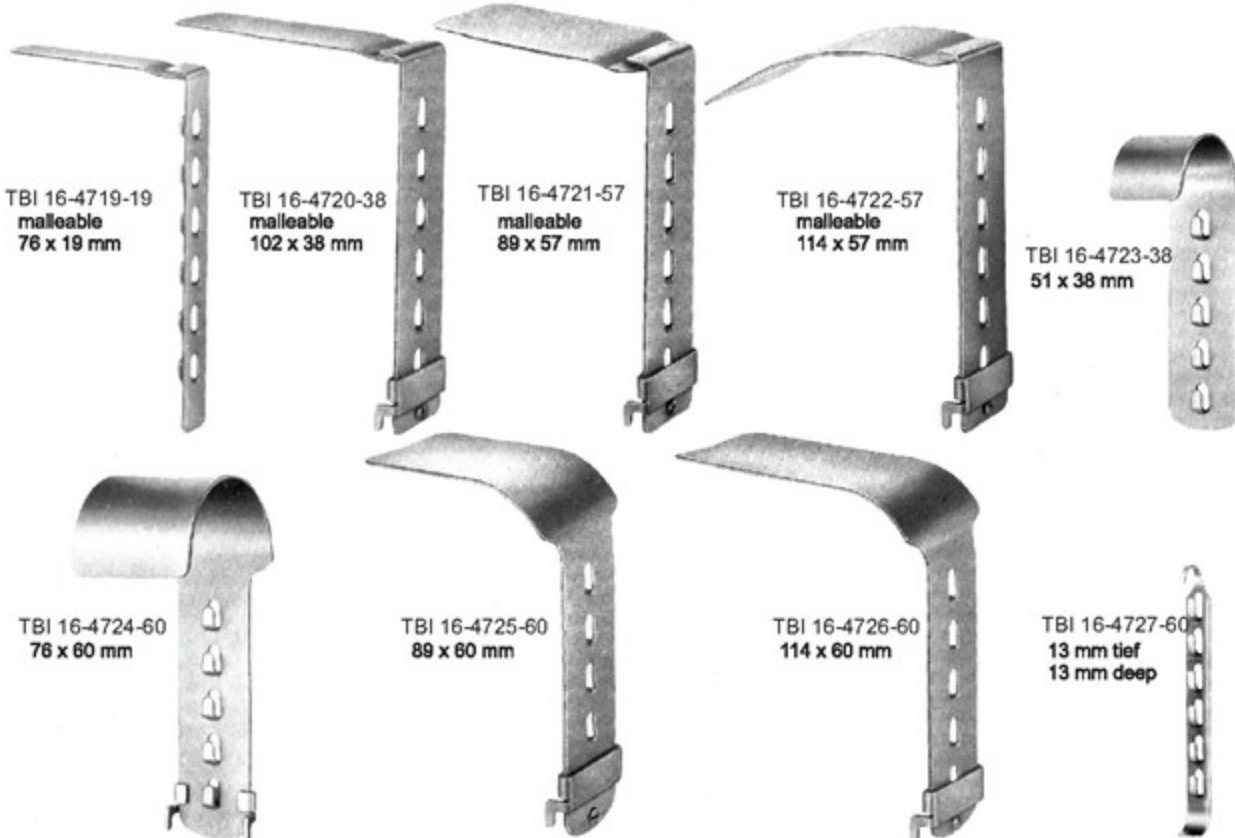

TBI 16-4719-19
 malleable
 76 x 19 mm

TBI 16-4720-38
 malleable
 102 x 38 mm

TBI 16-4721-57
 malleable
 89 x 57 mm

TBI 16-4722-57
 malleable
 114 x 57 mm

TBI 16-4723-38
 51 x 38 mm

TBI 16-4724-60
 76 x 60 mm

TBI 16-4725-60
 89 x 60 mm

TBI 16-4726-60
 114 x 60 mm

TBI 16-4727-60
 13 mm tief
 13 mm deep

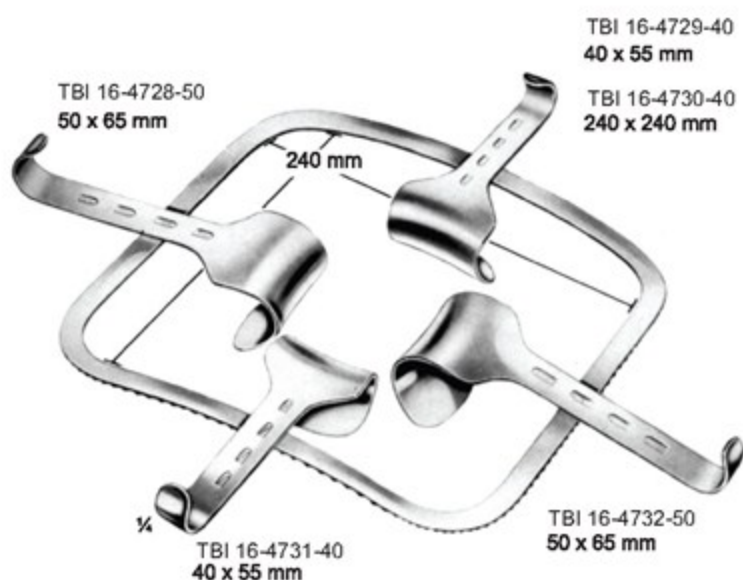

**KIRSCHNER**

TBI 16-4733-00

- TBI 16-4734-00 - Kirschner, Abdominal Retractor
- complete, consisting of:
 TBI 16-4735-00 - 2 Hook-on retractors, 40 x 55 mm
 TBI 16-4736-00 - 2 ditto, 50 x 65 mm
 TBI 16-44737-00 - Frame only, rigid, 240 x 240 mm

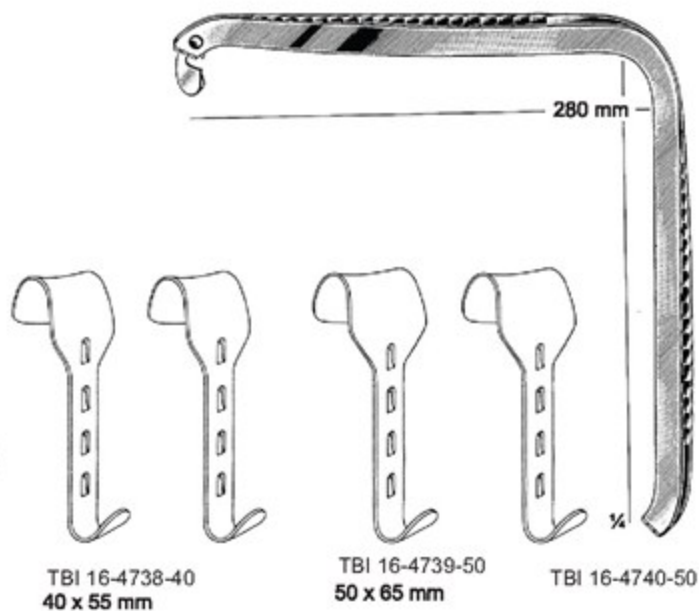
**KIRSCHNER**

TBI 16-4741-00

- TBI 16-4742-00- Kirschner, Abdominal Retractor, folding,
- large size, complete, consisting of:
 TBI 16-4743-00- 1 Frame folding type, large size
- 280 x 280 mm
 TBI 16-4744-00- 2 Hook-on retractors, 40 x 55 mm
 TBI 16-4745-00- 2 ditto, 50 x 65 mm
 TBI 16-4746-00- Frame only, folding type 280 x 280 mm

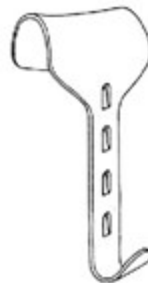
Hook-on Retractors for Kirschner and Franz Frames**Standard**TBI 16-4747-40
40 x 55 mmTBI 16-4748-50
50 x 65 mmTBI 16-4749-60
60 x 85 mmTBI 16-4750-78
78 x 65 mm**for corpulent patients**TBI 16-4751-80
80 x 90 mm

Measurements of retractors: Depth x Width

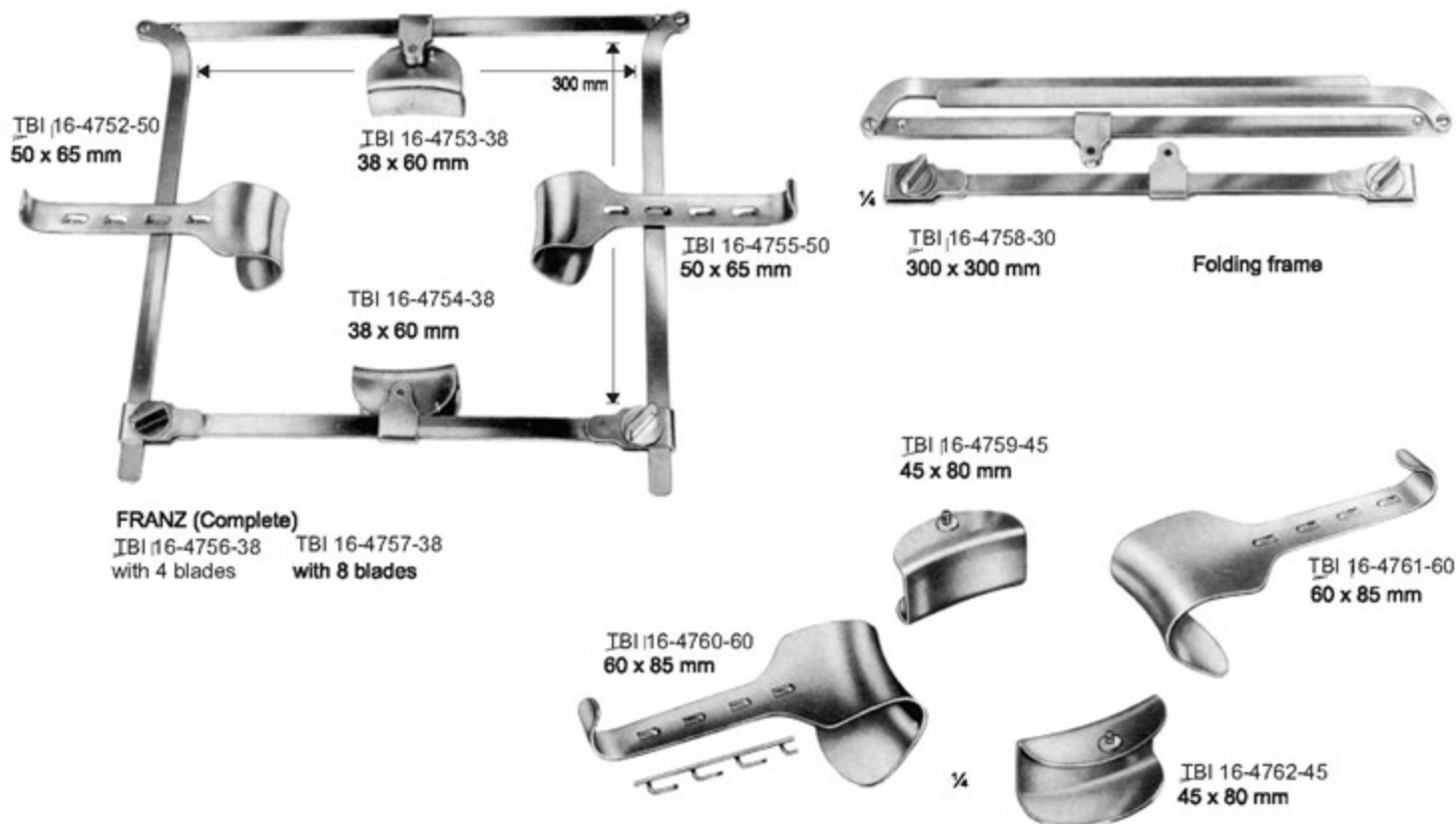

FRANZ (Complete)

TBI 16-4756-38 with 4 blades
 TBI 16-4757-38 with 8 blades

- TBI 16-4763-50 - Franz, Abdominal Retractor, folding, - complete, consisting of:
- TBI 16-4764-50 - 2 Hook-on retractors, 50 x 65 mm
- TBI 16-4765-50 - 2 exchangeable blades 38 x 60 mm
- TBI 16-4766-50 - Frame, folding, only, 300 x 300 mm

- TBI 16-4767-30 - Franz, Abdominal Retractor, folding, - complete, consisting of:
- TBI 16-4768-30 - 1 Frame folding, 300 x 300 mm
- TBI 16-4769-30 - 2 Hook-on retractors, 50 x 65 mm
- TBI 16-4770-30 - 2 ditto, 60 x 85 mm
- TBI 16-4771-30 - 2 exchangeable blades 38 x 60 mm
- TBI 16-4772-30 - 2 ditto, 45 x 80 mm

Intestinal and bladder

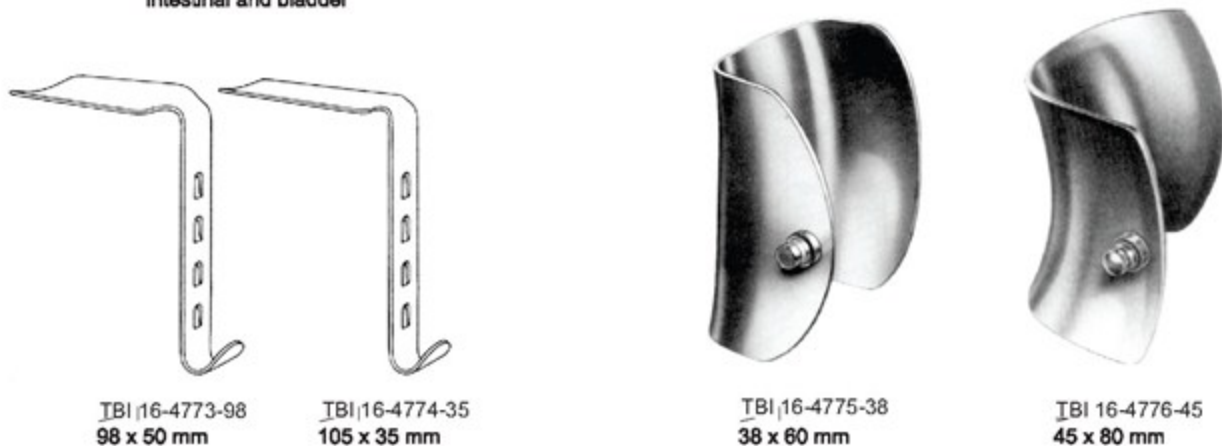

TBI 16-4773-98
 98 x 50 mm

TBI 16-4774-35
 105 x 35 mm

TBI 16-4775-38
 38 x 60 mm

TBI 16-4776-45
 45 x 80 mm

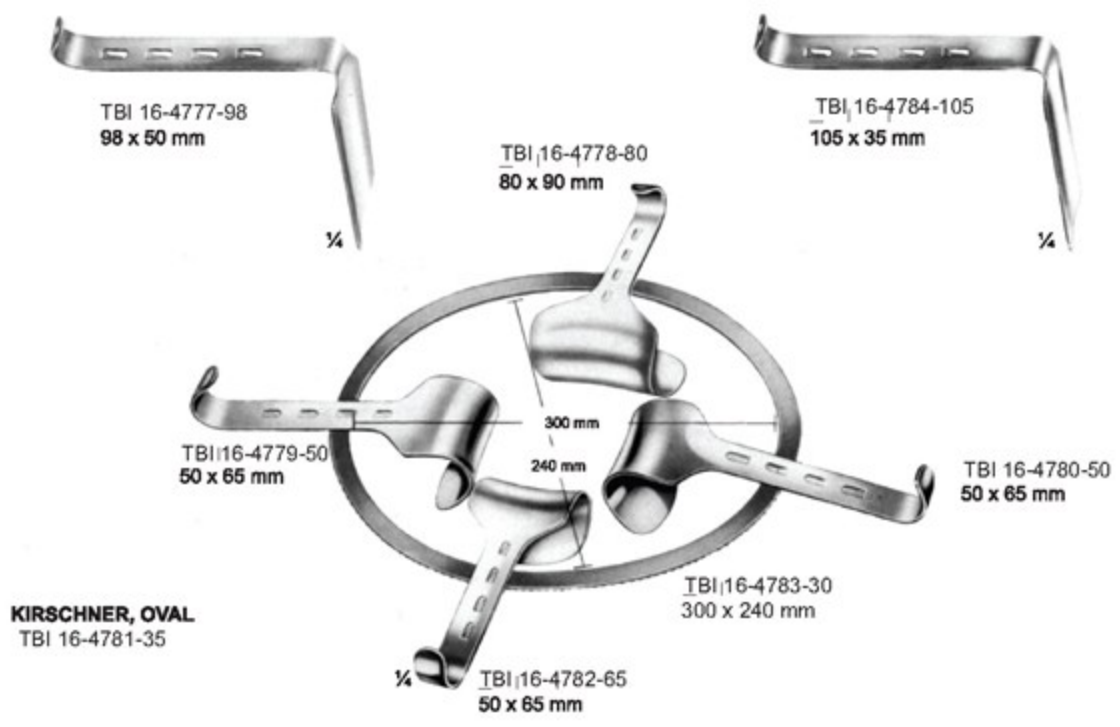

- TBI 16-4785-50 - Kirschner, Abdominal Retractor, Oval, complete, consisting of:
 - TBI 16-4786-50 - 1 Frame, 300 x 240 mm
 - TBI 16-4787-50 - 3 Hook-on retractors, 50 x 65 mm
 - TBI 16-4788-50 - 1 ditto, 80 x 90 mm
 - TBI 16-4789-50 - 1 ditto, 98 x 50 mm
 - TBI 16-4790-50 - 1 ditto, 105 x 35 mm
 - TBI 16-4791-50 - Frame only, 300 x 240 mm
- Hook-on retractors see bottom of page

Hook-on Retractors for Kirschner and Franz Frames

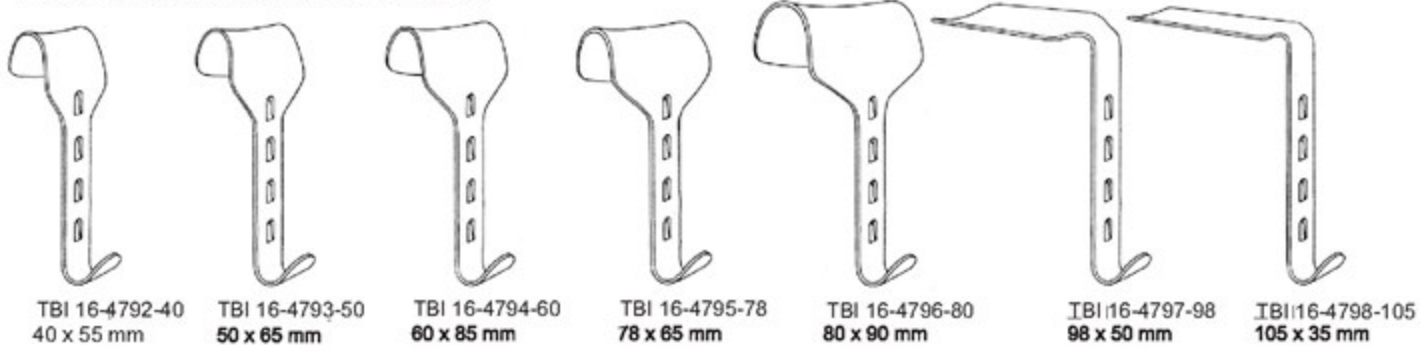

Measurements of retractors: Depth x Width



25 x 105 mm

LEGUEU
 IBI 16-4799-25
 25 cm/9 1/4"



67 x 105 mm

KOCHER
 IBI 16-4800-26
 26 cm/10 1/4"



56 x 105 mm

KOCHER
 IBI 16-4801-26
 26 cm/10 1/4"

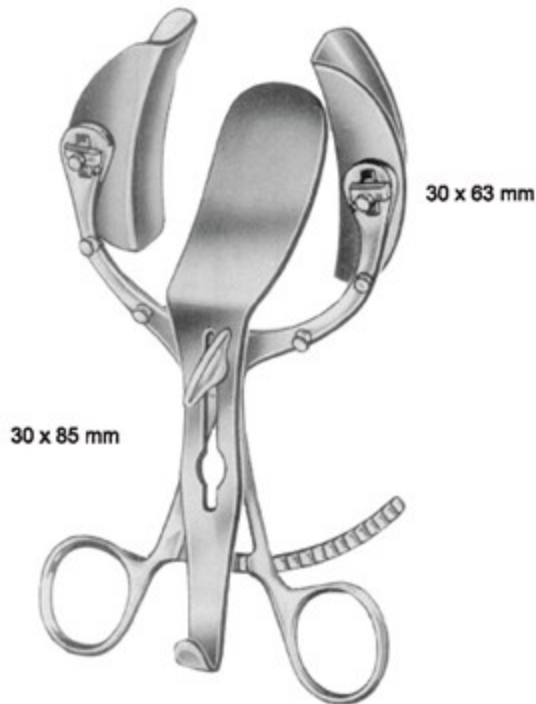

30 x 85 mm

30 x 63 mm

LEGUEU
 TBI 16-4802-30



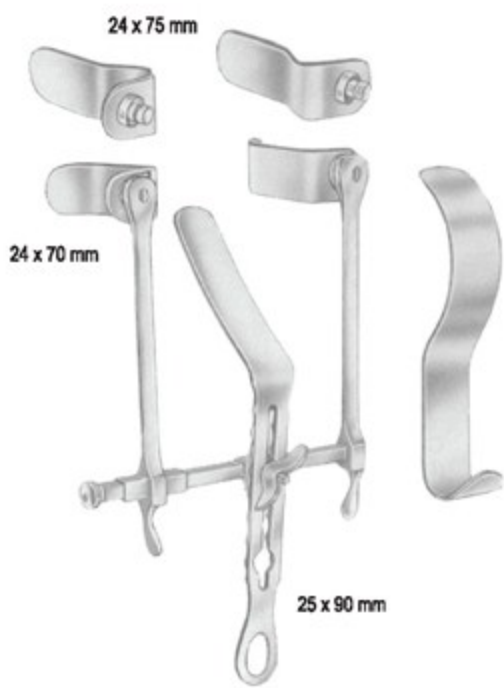

THOMSON-WALKER
TBI 16-4803-25

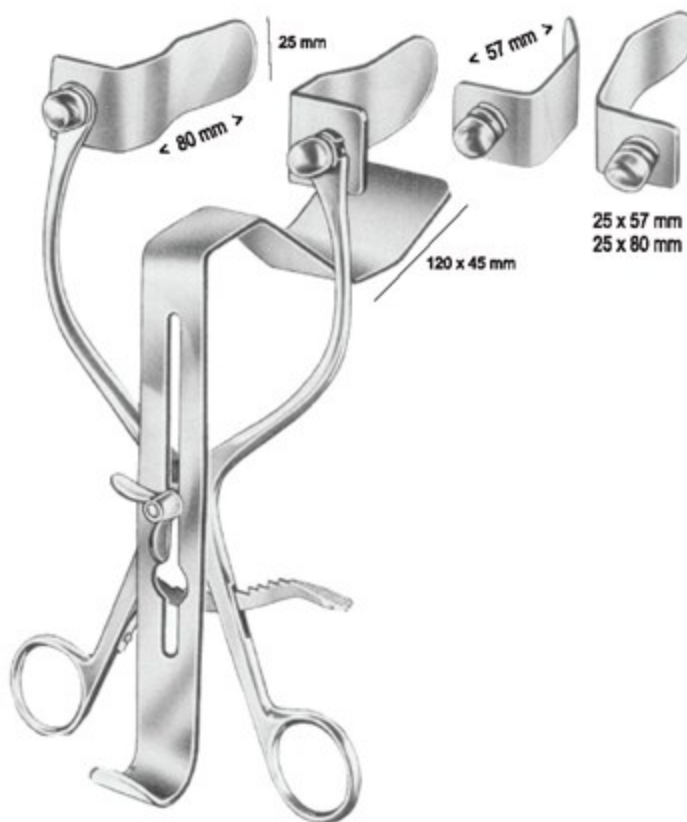

MILLIN
TBI 16-4804-25

Measurements of retractors: Depth x Width

EN Suture

DE Naht

ES Sutura

Page 346 to 372





Derf
TBI 17-5001-12
12.0cm



Derf
TBI 17-5002-12
12.5cm



Collier
TBI 17-5003-12
12.5cm

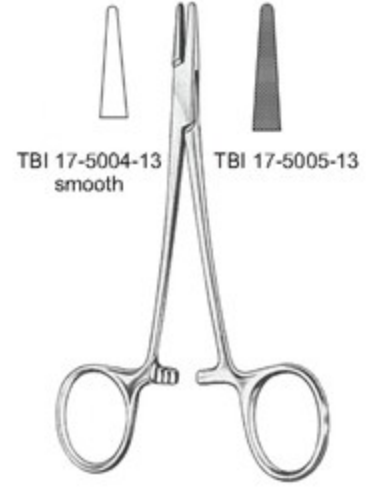

TBI 17-5004-13
smooth

TBI 17-5005-13

Webster
13.0cm

Nadelhalter

smooth jaws with special groove

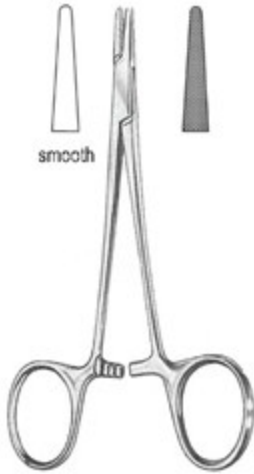

Halsey
TBI 17-5006-13 13.0cm TBI 17-5007-13



Neivert
TBI 17-5008-13
13.0cm



Hegar-Baumgartner
TBI 17-5009-12 12.5cm
TBI 17-5009-14 14.0cm



Brown
TBI 17-5010-13 13.0cm
TBI 17-5010-18 18.0cm

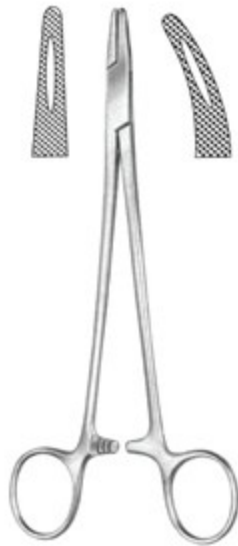

- | | | | |
|-------------------|--------|-------------------|----------------|
| Mayo-Hegar | | Mayo-Hegar | |
| TBI 17-5011-14 | 14.0cm | TBI 17-5012-14 | TBI 17-5013-16 |
| TBI 17-5011-15 | 15.0cm | TBI 17-5012-15 | TBI 17-5013-18 |
| TBI 17-5011-16 | 16.0cm | TBI 17-5012-16 | TBI 17-5013-20 |
| TBI 17-5011-18 | 18.0cm | TBI 17-5012-18 | |
| TBI 17-5011-20 | 20.0cm | TBI 17-5012-20 | |
| TBI 17-5011-22 | 22.0cm | TBI 17-5012-22 | |
| TBI 17-5011-24 | 24.0cm | TBI 17-5012-24 | |
| TBI 17-5011-26 | 26.0cm | TBI 17-5012-26 | |
| TBI 17-5011-28 | 28.0cm | TBI 17-5012-28 | |
| TBI 17-5011-30 | 30.0cm | TBI 17-5012-30 | |

- Crile-Murray**
 TBI 17-5014-15
 15.0cm

- Crile-Wood**
 TBI 17-5015-15 15.0cm
 TBI 17-5015-18 18.0cm
 TBI 17-5015-20 20.0cm



- | | | | |
|----------------|--------|----------------|----------------|
| Hegar | | Adson | |
| TBI 17-5016-20 | 20.0cm | TBI 17-5017-20 | TBI 17-5018-18 |
| TBI 17-5016-24 | 24.0cm | TBI 17-5017-24 | 18.0cm |

- Heaney**
 TBI 17-5019-21
 21.0cm

- Metzenbaum**
 TBI 17-5020-18
 18.0cm



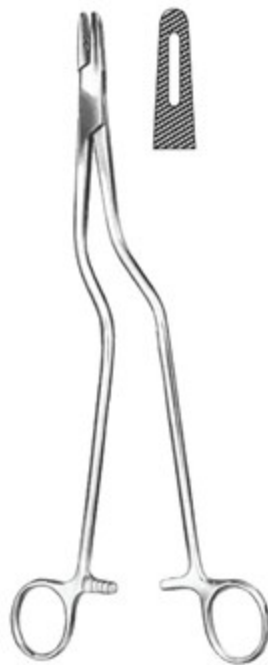

Masson-Luethy
 TBI 17-5021-26
 26.0cm



Sarot
 TBI 17-5022-18 18.0cm
 TBI 17-5022-26 26.0cm

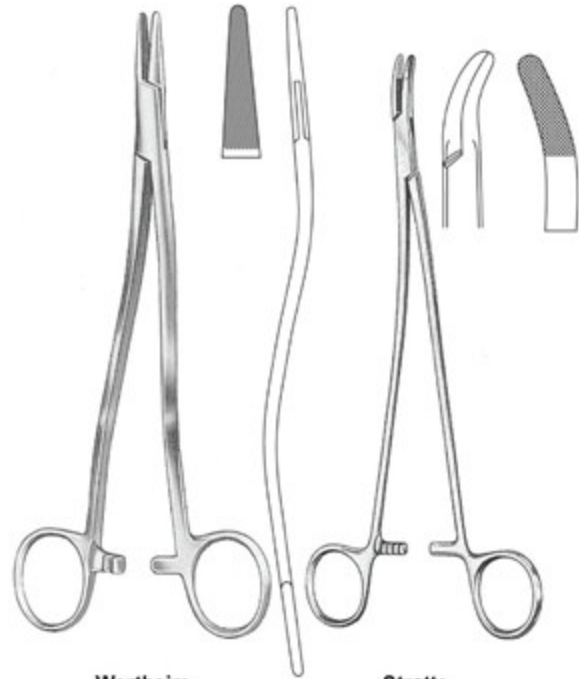

Wertheim
 TBI 17-5023-20 20.0cm
 TBI 17-5023-24 24.0cm



Stratte
 TBI 17-5024-23
 23.0cm



Bruce-Clarke
 TBI 17-5025-12
 12.5cm



Kilner
 TBI 17-5026-13 13.5cm
 TBI 17-5026-16 16.5cm



Thomson-Walker
 TBI 17-5027-20
 20.0cm



Bozemann
 TBI 17-5028-20 20.0cm
 TBI 17-5028-24 24.0cm



Johnson
 TBI 17-5029-27
 27.0cm



Finocchietto
 TBI 17-5030-18 18.0cm
 TBI 17-5030-20 20.0cm
 TBI 17-5030-27 27.0cm



Masson
 TBI 17-5031-27
 27.0cm



Wangenstein
 TBI 17-5032-27
 27.0cm





Wangensteen
TBI 17-5033-27
27.0cm



Jamison
TBI 17-5034-23
23.5cm



M.G.H. (mass-general-hospital)
TBI 17-5035-17
17.0cm



Gillies
TBI 17-5036-16 16.0cm (right hand)
TBI 17-5036-17 16.0cm (left hand)

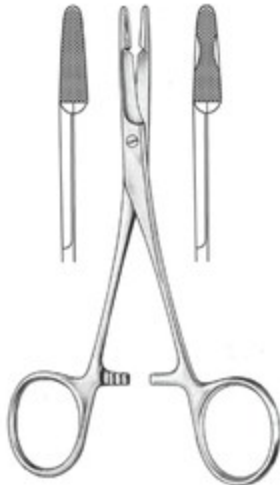

Olsen-Hegar
TBI 17-5037-14 14.0cm TBI 17-5038-14
with blood groove



Olsen-Hegar
TBI 17-5039-17
17.0cm

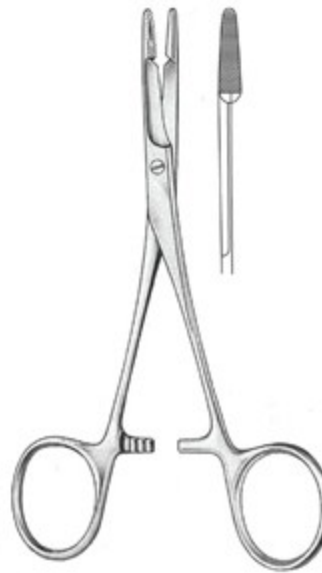

Olsen-Hegar
TBI 17-5040-17
17.0cm

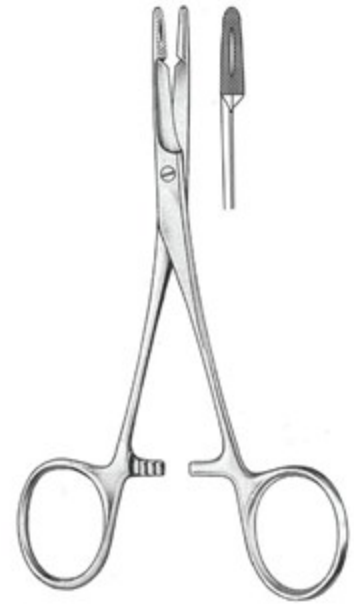

Olsen-Hegar
TBI 17-5041-14 14.0cm
TBI 17-5041-18 18.0cm



Crile
 TBI 17-5042-15
 15.0cm



Toennis
 TBI 17-5043-18
 18.0cm



Lichtenberg
 TBI 17-5044-20
 20.0cm



Macphail
 TBI 17-5045-14 14.0cm
 TBI 17-5045-16 16.0cm
 TBI 17-5045-18 18.0cm
 TBI 17-5045-20 20.0cm



Mathieu
 TBI 17-5046-14 14.0cm
 TBI 17-5046-17 17.0cm
 TBI 17-5046-20 20.0cm
 TBI 17-5046-24 24.0cm



Delicate
Mathieu
 TBI 17-5047-14 14.0cm
 TBI 17-5047-17 17.0cm
 TBI 17-5047-20
 TBI 17-5047-24



Mathieu
 TBI 17-5049-17 17.0cm
 TBI 17-5049-20 20.0cm





BARRAQUER
 TBI 17-5050-16
 16.0cm



ARRUGA
 TBI 17-5051-14 14.0cm
 TBI 17-5052-14 14.0cm



KALT
 TBI 17-5053-14
 14.0cm



KALT-ARRUGA
 TBI 17-5054-14
 14.0cm



CASTROVIEJO-KALT
 TBI 17-5055-13
 13.5cm



BOYNTON
 TBI 17-5056-12
 12.0cm



ARRUGA
 TBI 17-5057-16 16.0cm
 TBI 17-5058-16 16.0cm



STEVENSON
 TBI 17-5059-11
 11.0cm



STEVENS
 TBI 17-5060-13 13.0cm
 TBI 17-5060-15 15.0cm



WECKER
 TBI 17-5061-15
 15.0cm



BARRAQUER
 TBI 17-5062-14
 14.0cm



CASTROVIEJO
 TBI 17-5063-09
 9.0cm



CASTROVIEJO
 TBI 17-5064-09
 9.0cm



CASTROVIEJO
 TBI 17-5065-09
 9.0cm



CASTROVIEJO
 TBI 17-5066-09
 9.0cm



CASTROVIEJO
 TBI 17-5067-14
 14.0cm



CASTROVIEJO
 TBI 17-5068-14
 14.0cm



BARRAQUER
 TBI 17-5069-10
 10.0cm



BARRAQUER
 TBI 17-5070-10
 10.0cm





BARRAQUER-TROUTMAN
TBI 17-5071-10
10.0cm



BARRAQUER-TROUTMAN
TBI 17-5072-10
10.0cm



BARRAQUER
TBI 17-5073-14
14.0cm



BARRAQUER
TBI 17-5074-13
13.0cm

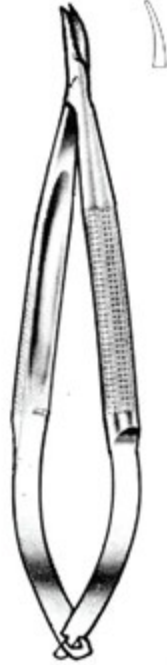

BARRAQUER
TBI 17-5075-11
11.0cm



BARRAQUER
TBI 17-5076-13
13.0cm



CASTROVIEJO
 TBI 17-5077-14 14.0cm
 TBI 17-5077-17 17.0cm



CASTROVIEJO
 TBI 17-5078-14 14.0cm
 TBI 17-5078-17 17.0cm



CASTROVIEJO
 TBI 17-5079-14 14.0cm
 TBI 17-5079-17 17.0cm



CASTROVIEJO
 TBI 17-5080-14 14.0cm
 TBI 17-5080-17 17.0cm



JACOBSON
 TBI 17-5081-18 18.5cm
 TBI 17-5081-21 21.0cm



JACOBSON
 TBI 17-5082-18 18.5cm
 TBI 17-5082-21 21.0cm



CASTROVIEJO
 TBI 17-5083-01 10.0cm
 TBI 17-5083-02 10.0cm



CASTROVIEJO
 TBI 17-5084-01 10.0cm
 TBI 17-5084-02 10.0cm





TBI 17-5085-16
16.0cm



TBI 17-5086-01 23.0cm Fig.1
 TBI 17-5086-02 23.0cm Fig.2
 TBI 17-5086-03 19.0cm Fig.3



CASTROVIEJO-BARRAQUER
 TBI 17-5087-12
 12.0cm



CASTROVIEJO
 TBI 17-5088-13
 13.0cm



CASTROVIEJO
 TBI 17-5089-12
 12.0cm



REVERDIN
14.0cm



Fig.1
TBI 17-5090-01



Fig.2
TBI 17-5090-02



Fig.3
TBI 17-5090-03



Fig.4
TBI 17-5090-04



REVERDIN
19.0cm
21.0cm



REVERDIN
23.0cm



Fig.1
TBI 17-5091-01
TBI 17-5092-01
TBI 17-5093-01



Fig.2
TBI 17-5091-02
TBI 17-5092-02
TBI 17-5093-02



Fig.3
TBI 17-5091-03
TBI 17-5092-03
TBI 17-5093-03



Fig.4
TBI 17-5091-04
TBI 17-5092-04
TBI 17-5093-04





TBI 17-5094-20 20.0cm
 TBI 17-5095-20 20.0cm



TBI 17-5096-20 20.0cm
 TBI 17-5097-20 20.0cm



TBI 17-5098-20 20.0cm
 TBI 17-5099-20 20.0cm



DESCHAMPS
 TBI 17-5100-21 21.0cm
 TBI 17-5101-21 21.0cm

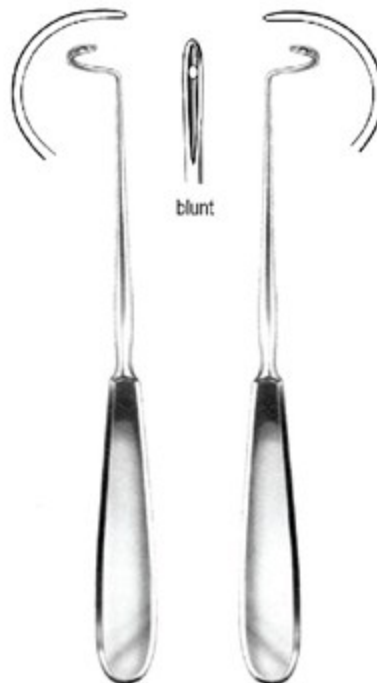

DESCHAMPS
 TBI 17-5102-21 21.0cm
 TBI 17-5103-21 21.0cm

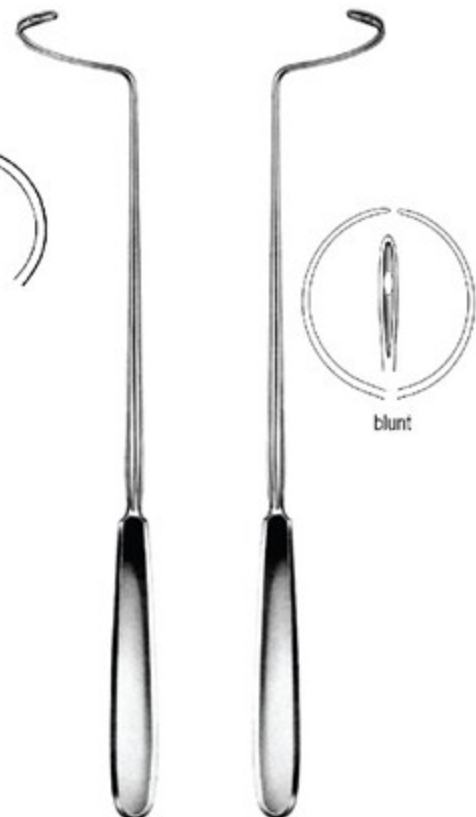

DESCHAMPS
 TBI 17-5104-28 28.0cm
 TBI 17-5105-28 28.0cm



SCHMIEDEN-DICK
TBI 17-5106-32
32.0cm



SCHMIEDEN
TBI 17-5107-21
21.0cm



COOPER
TBI 17-5108-20
20.0cm



COOPER
TBI 17-5109-19
19.0cm



YOUNG
TBI 17-5110-23
23.0cm



YOUNG
TBI 17-5111-25
25.0cm
with 3 needles.



TBI 17-5111-01



TBI 17-5111-02



TBI 17-5111-03



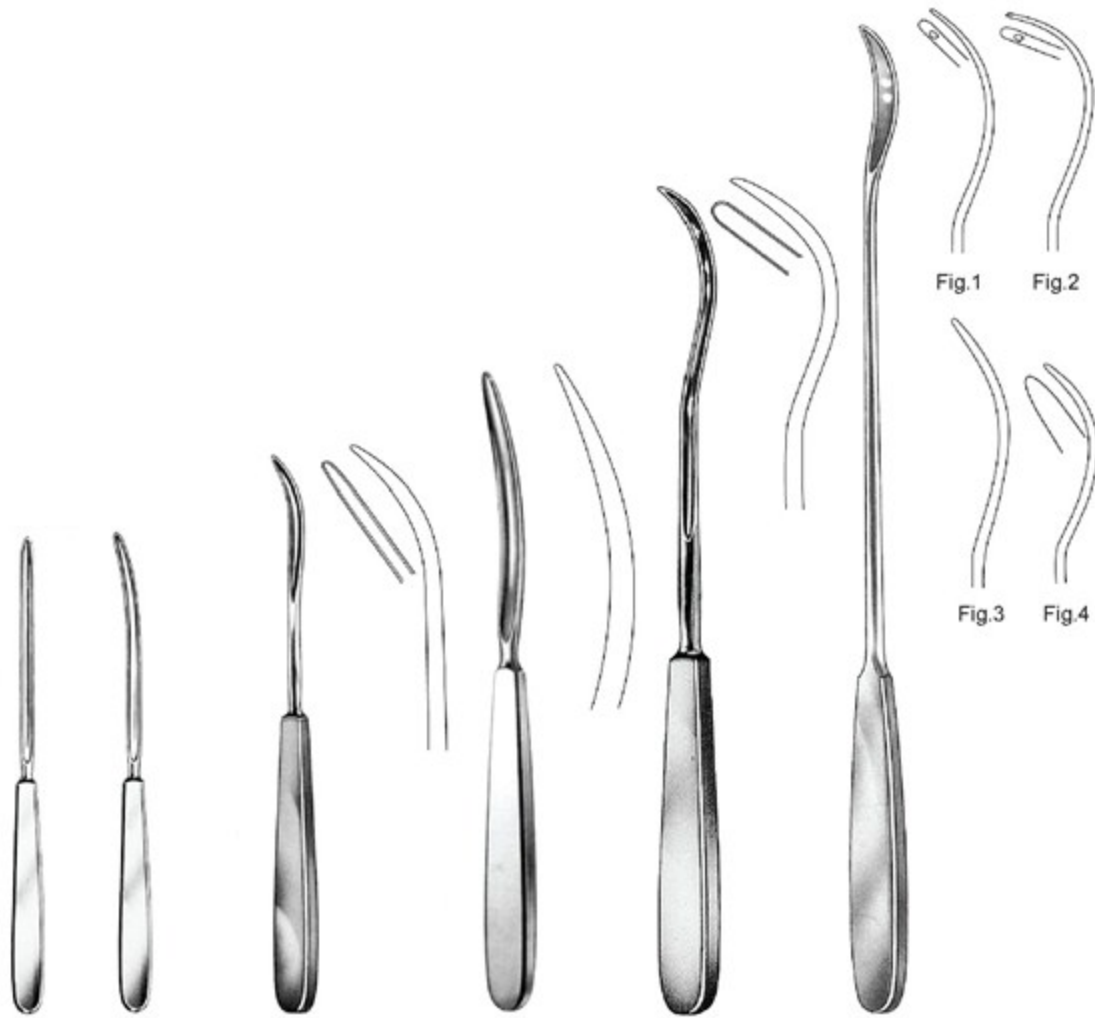

PAYR
 22.0cm
 TBI 17-5112-22
 TBI 17-5113-22

KÖNIG
 TBI 17-5114-03 19.5cm
 TBI 17-5114-05 19.5cm
 TBI 17-5114-07 20.0cm

MOD
 TBI 17-5115-19
 19.0cm

KIRSCHNER
 TBI 17-5116-25
 25.0cm

BRUNNER
 30.0cm
 TBI 17-5117-01 Fig.1
 TBI 17-5117-02 Fig.2
 TBI 17-5117-03 Fig.3
 TBI 17-5117-04 Fig.4



MICHEL
 TBI 17-5118-12
 12.0cm



MICHEL
 TBI 17-5119-12
 12.0cm



WACHENFELDT
 TBI 17-5120-12
 12.5cm



WACHENFELDT
 TBI 17-5121-12
 12.0cm



WACHENFELDT
 TBI 17-5122-12
 12.5cm



HEGENBARTH
 TBI 17-5123-12
 12.5cm



CHILDE
 TBI 17-5124-18
 18.0cm



CHILDE
 TBI 17-5125-18
 18.0cm



MICHEL
 TBI 17-5126-12
 12.5cm



RICHTER- HEATH
 TBI 17-5127-14
 14.0cm



COLLIN
 TBI 17-5128-13
 13.0cm





TC GOLD



Castroviejo

14cm/5½"
18cm/7"
21cm/8¼"



TBI 17-5131-14
TBI 17-5131-18
TBI 17-5131-21

Smooth



TBI 17-5132-14
TBI 17-5132-18
TBI 17-5132-21



14cm/5½"
18cm/7"
21cm/8¼"

TBI 17-5133-14
TBI 17-5133-18
TBI 17-5133-21



TBI 17-5134-14
TBI 17-5134-18
TBI 17-5134-21



Kalt
14cm/5½"



TBI 17-5135-14



TBI 17-5136-14



Barraquer
TBI 17-5137-14
14cm/5 ½"



Castroviejo
TBI 17-5138-13
13cm/5"



TBI 17-5139-18



3I 17-5140-18
Smooth



Hepp-Schiedel
18cm/7"

TC GOLD



Arruga
14cm/5½"

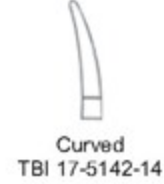

Jacobson
 TBI 17-5143-18 18cm/7"
 TBI 17-5143-20 20cm/8"
 TBI 17-5143-23 23cm/9"



Diethrich

Straight		Curved
TBI 17-5144-16	16cm/6¼"	TBI 17-5145-16
TBI 17-5144-18	18cm/7"	TBI 17-5145-18
TBI 17-5144-20	20cm/8"	TBI 17-5145-20
TBI 17-5144-23	23cm/9"	TBI 17-5145-23
TBI 17-5144-25	25cm/10"	TBI 17-5145-25





TC GOLD

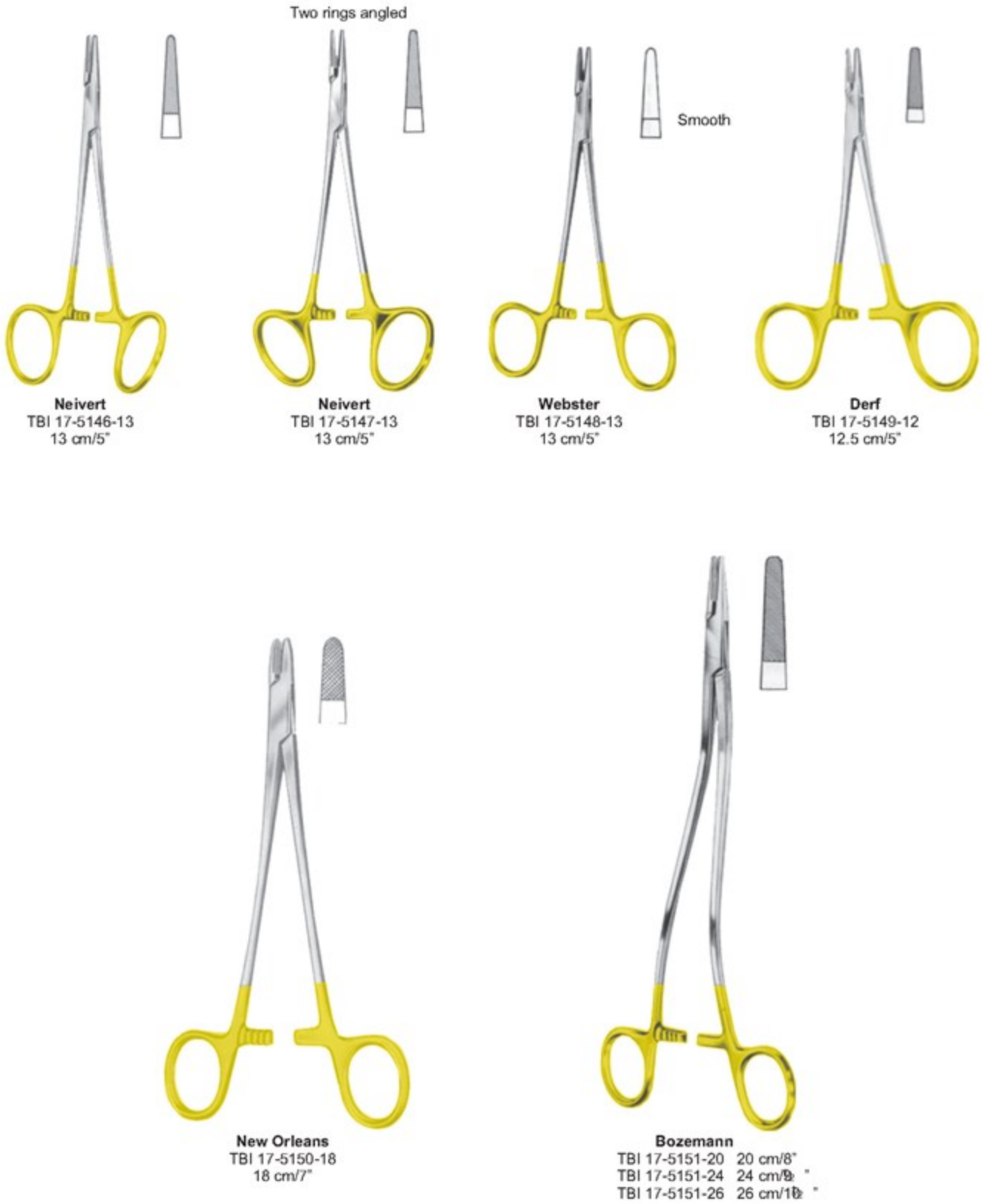

TC GOLD



Mayo-Hegar



- | | |
|----------------|--------------------------|
| TBI 17-5152-16 | 16cm/6¼" |
| TBI 17-5152-18 | 18cm/7" |
| TBI 17-5152-20 | TBI 17-5153-20 20cm/8" |
| TBI 17-5152-24 | TBI 17-5153-24 24cm/9½" |
| TBI 17-5152-26 | TBI 17-5153-26 26cm/10½" |
| TBI 17-5152-30 | 30cm/12" |



Hegar-Baumgartner
 TBI 17-5154-14
 14cm/5½"



Heavy Pattern

Mayo-Hegar
 TBI 17-5155-20 20cm/8"
 TBI 17-5155-24 24cm/9½"



De Bakey
 TBI 17-5156-18 18cm/7"
 TBI 17-5156-20 20cm/8"
 TBI 17-5156-23 23cm/9"
 TBI 17-5156-26 26cm/10¼"
 TBI 17-5156-31 31cm/12¼"



De Bakey-Fine
 TBI 17-5157-18
 TBI 17-5157-20
 TBI 17-5157-23
 TBI 17-5157-26
 TBI 17-5157-31



TC GOLD



Baby-Crile-Wood
TBI 17-5158-15
15cm/6"

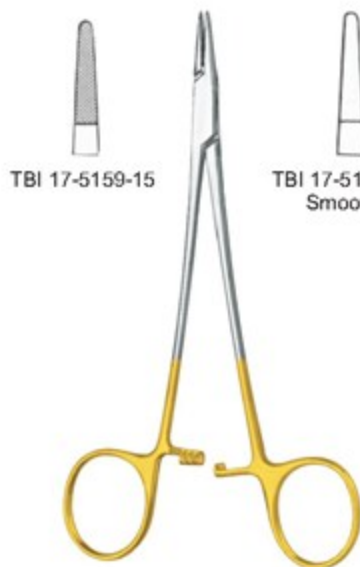

TBI 17-5159-15

TBI 17-5160-15
Smooth

Crile-Wood
15cm/6"



Crile-Wood

	cm	in
TBI 17-5161-18	18	7"
TBI 17-5161-20	20	8"
TBI 17-5161-23	23	9"
TBI 17-5161-26	26	10¼"
TBI 17-5161-31	31	12¼"

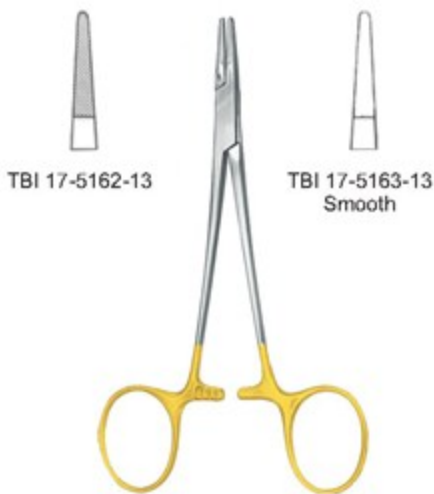

TBI 17-5162-13

TBI 17-5163-13
Smooth

Halsey
13cm/5"



Converse
TBI 17-5164-12
12.5cm/5"



Kilner
TBI 17-5165-13
13.5cm/5¼"



TC GOLD



Hegar-Vascular
 TBI 17-5166-14 14cm/5½"
 TBI 17-5166-18 18cm/7"
 TBI 17-5166-20 20cm/8"
 TBI 17-5166-23 23cm/9"



Ryder
 TBI 17-5167-13
 TBI 17-5167-15
 TBI 17-5167-18
 TBI 17-5167-20
 TBI 17-5167-23
 TBI 17-5167-26



Micro-Ryder
 TBI 17-5168-13 13cm/5"
 TBI 17-5168-15 15cm/6"
 TBI 17-5168-18 18cm/7"
 TBI 17-5168-20 20cm/8"
 TBI 17-5168-23 23cm/9"
 TBI 17-5168-26 26cm/10¼"



(Swedish Pattern)
 TBI 17-5169-15 15cm/6"
 TBI 17-5169-17 17cm/6¾"
 TBI 17-5169-20 20cm/8"



Sarot
 TBI 17-5170-18 18cm/7"
 TBI 17-5170-26 26cm/10¼"





TC GOLD



Stratte
TBI 17-5171-23
23cm/9"



Masson
TBI 17-5172-27
27cm/10½"

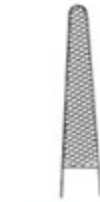

Wangenstein
TBI 17-5173-27
27cm/10½"



Finocchietto
TBI 17-5174-20 20cm/8"
TBI 17-5174-27 27cm/10½"

TC GOLD



Mathieu

14cm/5½" TBI 17-5175-14
 17cm/6¾" TBI 17-5175-17
 20cm8" TBI 17-5175-20
 24cm/9½" TBI 17-5175-24



Mathieu

TBI 17-5176-14
 TBI 17-5176-17
 TBI 17-5176-20
 TBI 17-5176-24



Mathieu-Ryder

TBI 17-5177-17
 TBI 17-5177-20



Langenbeck

16cm/6¼" TBI 17-5178-16
 18cm/7" TBI 17-5178-18
 20cm/8" TBI 17-5178-20



Langenbeck-Ryder

TBI 17-5179-18
 TBI 17-5179-20



Lichtenberg

TBI 17-5180-20





TC GOLD



Toennis
TBI 17-5181-18
18 cm/7"



Mathieu-Kocher
TBI 17-5182-14 14 cm/5½"
TBI 17-5182-17 17 cm/6¼"
TBI 17-5182-20 20 cm/8"



Axhausen
TBI 17-5183-18
18.5 cm/7¼"



Zweifel
TBI 17-5184-20 20 cm/8"
TBI 17-5184-23 23 cm/9"

TC GOLD



TBI 17-5185-20 20 cm/8"
 TBI 17-5185-25 25 cm/10"



Mathieu
 TBI 17-5186-20 20 cm/8"
 TBI 17-5186-24 24 cm/9½"



Metzenbaum
 TBI 17-5187-17 17 cm/8¼"
 TBI 17-5187-20 20 cm/8"



Arruga
 16 cm/6¼"



TBI 17-5188-16 TBI 17-5189-16



Boynton
 TBI 17-5190-12
 12 cm/4¾"



Hosel
 TBI 17-5191-20 20 cm/8"
 TBI 17-5191-25 25 cm/10"



TC GOLD



Baby-Olsen-Hegar
 TBI 17-5192-11
 11.5 cm/4½"



Olsen-Hegar
 TBI 17-5193-14
 14 cm/5½"



Olsen-Hegar
 TBI 17-5194-17
 17 cm/6¾"



Olsen-Hegar
 TBI 17-5195-18
 18 cm/7"



Gillies-Slim
 TBI 17-5196-14
 14.5 cm/5½"



Gillies
 TBI 17-5197-16 (right hand)
 TBI 17-5198-16 (left hand)
 16 cm/6¼"

- EN** Neurosurgery
- DE** Neurochirurgie
- ES** Neuro Cirugía

Page 373 to 387

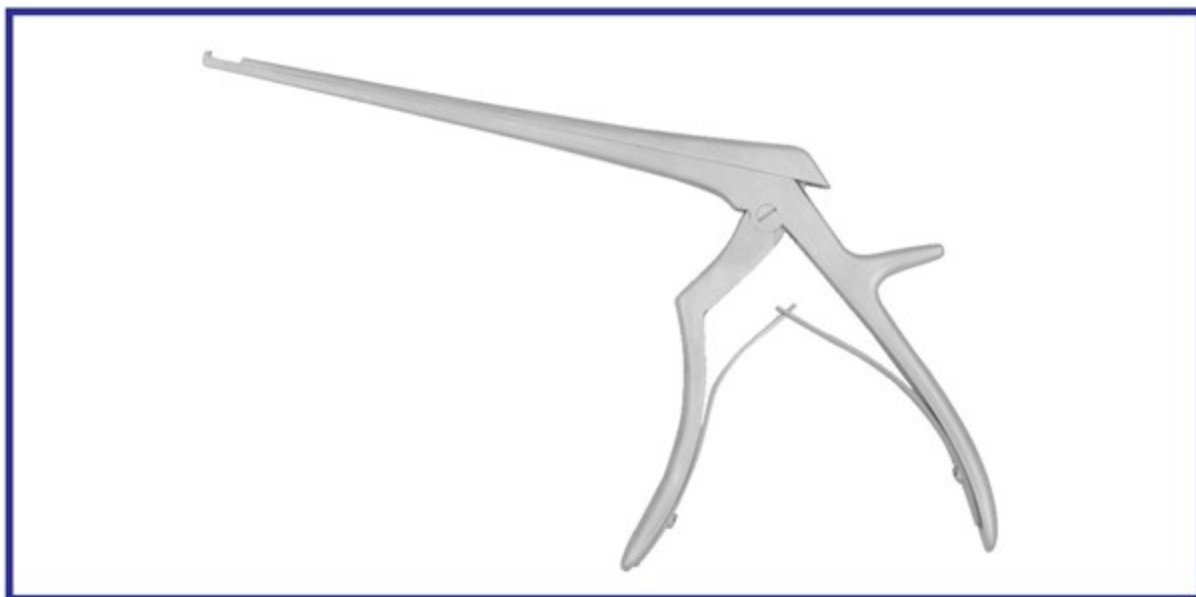

- EN — Dura Hooks, Nerve Hooks, Dura Dissectors
 DE — Durahaken, Nervhaken, Dura-Dissektoren
 ES — Ganchos para dura-madre, Ganchos para nervios, Disecadores de dura-madre



FRAZIER
TBI 18-5301-15
15 cm/5 1/4"



HOEN
TBI 18-5302-15
15 cm/5 1/4"



HOEN
TBI 18-5303-15
15 cm/5 1/4"



SACHS
TBI 18-5304-21
21 cm/8 1/4"



MILLIGAN
TBI 18-5305-21
21 cm/8 1/4"



SACHS
TBI 18-5306-21
21 cm/8 1/4"



TBI 18-5307-22
22 cm/8 3/4"



WOODSON
TBI 18-5308-25
25 cm/9 1/2"



DAVIS
TBI 18-5309-24
24.5 cm/9 3/4"



TBI 18-5310-21
21 cm/8 1/4"



FAGER
TBI 18-5311-20
20 cm/7 1/2"



FAGER
TBI 18-5312-20
20 cm/7 1/2"



LOVE
 TBI 18-5313-21
 21.5 cm/8 1/2"

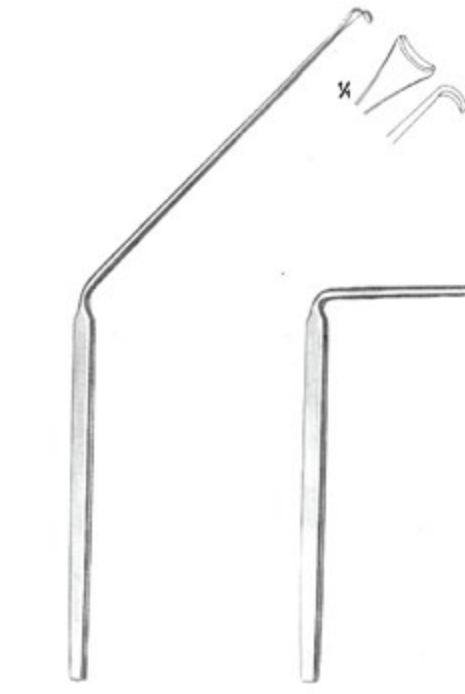

LOVE
 TBI 18-5314-17
 17.5 cm/6 3/4"

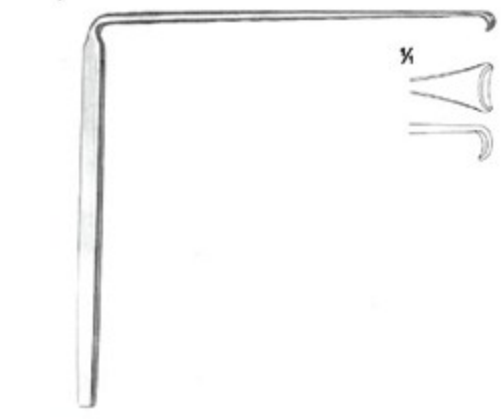

LOVE
 TBI 18-5315-11
 11 cm/4 3/8"



WOODSON
 TBI 18-5316-17
 17 cm/6 3/4"

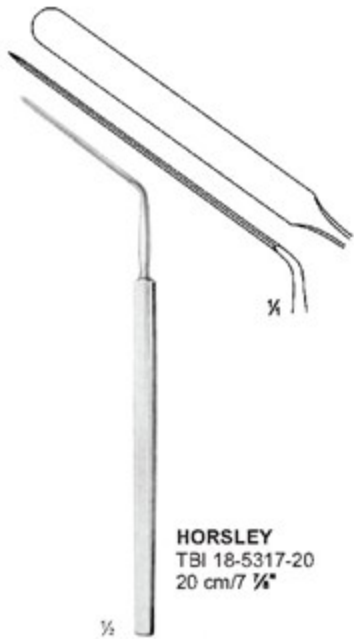

HORSLEY
 TBI 18-5317-20
 20 cm/7 7/8"



SACHS
 TBI 18-5318-21
 21 cm/8 1/4"

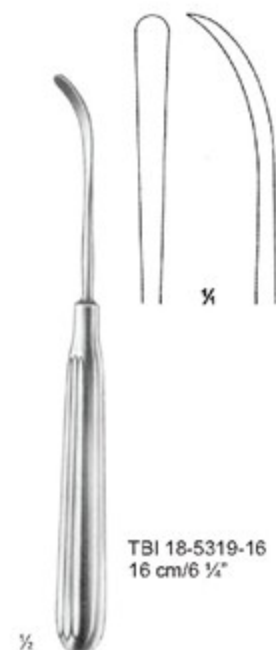

TBI 18-5319-16
 16 cm/6 1/4"

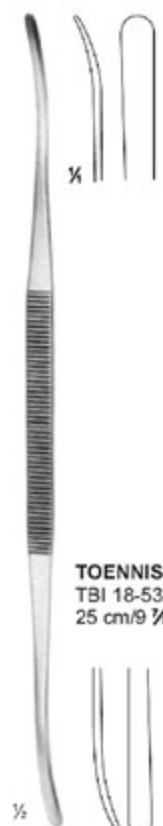

TOENNIS
 TBI 18-5320-20
 25 cm/9 7/8"



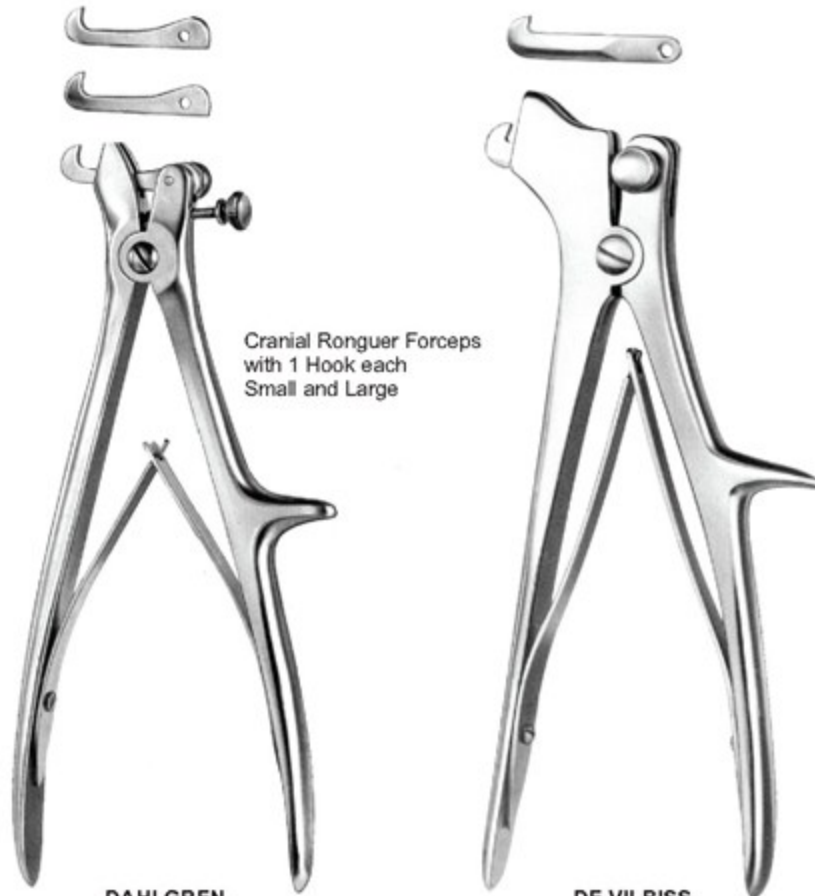

Cranial Rongeur Forceps
with 1 Hook each
Small and Large

DAHLGREN
TBI 18-5321-20
20 cm/7 7/8"

DE VILBISS
TBI 18-5322-21
21 cm/8 1/4"



McKENZIE
TBI 18-5323-15 15cm/5 7/8"
TBI 18-5323-19 19cm/7 1/2"

McKENZIE
TBI 18-5324-15 15cm/5 7/8"
TBI 18-5324-19 19cm/7 1/2"

RANEY
TBI 18-5325
Applying and removing
forceps for scalp hemostasis clip



GIGLI-WIRE SAW
 2 wires twisted

- TBI 18-5326-30 30cm
- TBI 18-5326-40 40cm
- TBI 18-5326-50 50cm
- TBI 18-5326-60 60cm
- TBI 18-5326-70 70cm

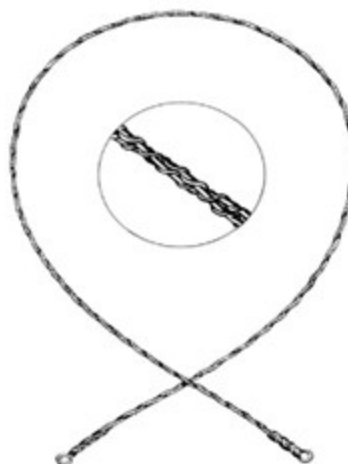

GIGLI-WIRE SAW
 6 wires twisted

- TBI 18-5327-30 30cm
- TBI 18-5327-40 40cm
- TBI 18-5327-50 50cm



GIGLI
 TBI 18-5328-07
 7 cm/2 3/4"
 Hook handle
 for wire saw



De MARTEL
 TBI 18-5329-33
 33 cm/13"
 Conductor for
 wire saws





CUSHING
 TBI 18-5330-17 17cm/6 1/4"
 TBI 18-5330-20 20cm/7 7/8"
 TBI 18-5330-28 28cm/11"



OLIVECRONA
 18 cm/7 1/4"
 width of spatulas

Concave
 TBI 18-5331-18
 TBI 18-5332-18
 TBI 18-5333-18
 TBI 18-5334-18



upper end
 7 + 9 mm
 11 + 13 mm
 15 + 18 mm
 18 + 22 mm

Convex
 TBI 18-5335-18
 TBI 18-5336-18
 TBI 18-5337-18
 TBI 18-5338-18

lower end



SCOVILLE
 TBI 18-5339-23
 23 cm/9"



HOLSHER
 TBI 18-5340-24
 24 cm/9 1/2"

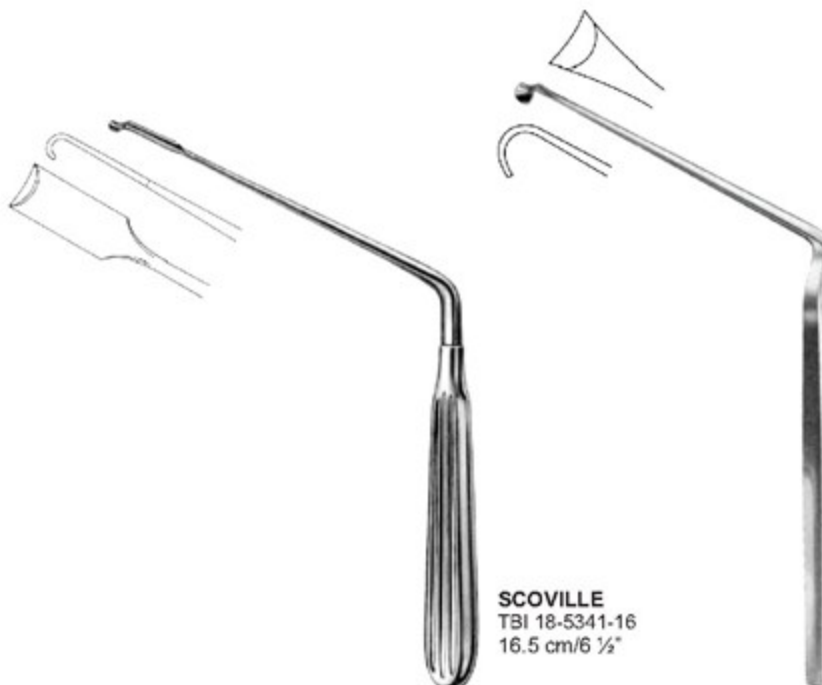

SCOVILLE
 TBI 18-5341-16
 16.5 cm/6 1/2"

TBI 18-5342-21
 21 cm/8 1/4"



GRONINGEN
 TBI 18-5343-26
 26.5 cm/10 3/4"

GRONINGEN
 TBI 18-5344-26
 26.5 cm/10 3/4"

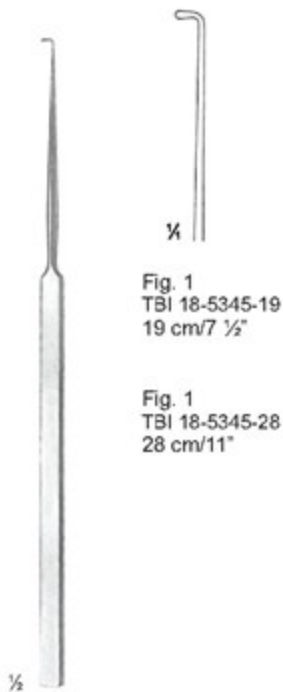

CUSHING

Fig. 1
 TBI 18-5345-19
 19 cm/7 1/2"

Fig. 1
 TBI 18-5345-28
 28 cm/11"

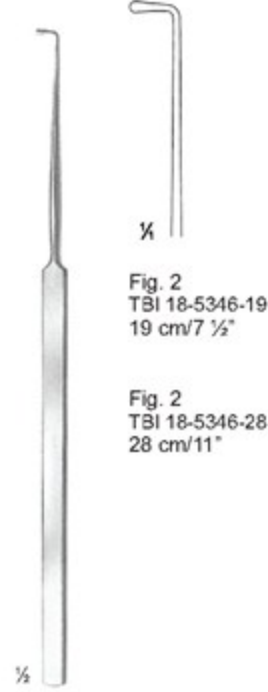

CUSHING

Fig. 2
 TBI 18-5346-19
 19 cm/7 1/2"

Fig. 2
 TBI 18-5346-28
 28 cm/11"



SMITHWICK

DF-237-2787
 17 cm/6 3/4"

TBI 18-5347-21
 21 cm/8 1/4"





GRAHAM
TBI 18-5348-16
16.5 cm/6 1/2"



SACHS
TBI 18-5349-17
17 cm/6 3/4"



FRAZIER

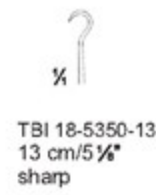

TBI 18-5350-13
13 cm/5 1/8"
sharp

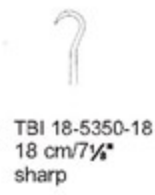

TBI 18-5350-18
18 cm/7 1/8"
sharp



ADSON
TBI 18-5351-20
20 cm/7 7/8"



KRAYENBÜHL
19 cm/7 1/2"



Fig. 1
TBI 18-5352-19



Fig. 2
TBI 18-5353-19

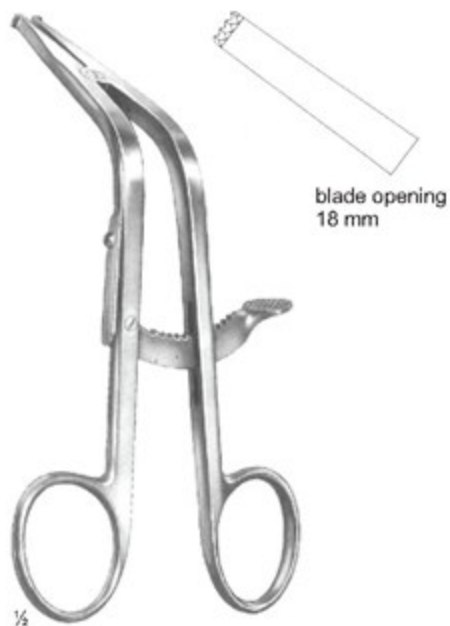

Fig. 1
TBI 18-5354-19

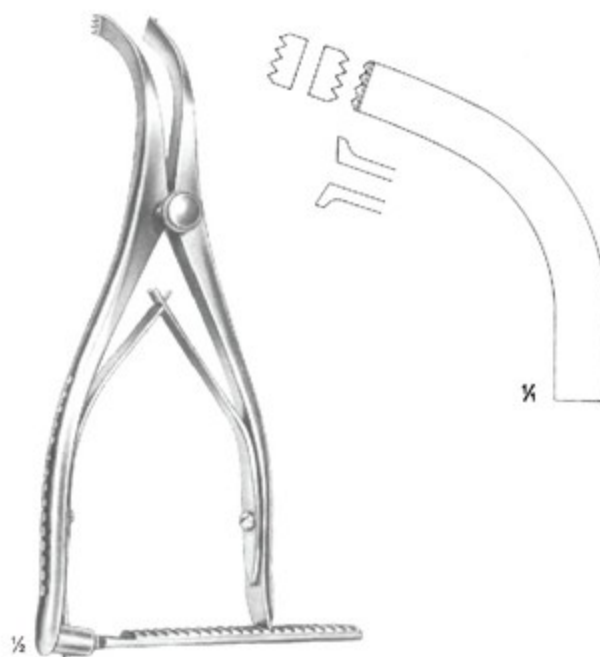

Fig. 2
TBI 18-5355-19





CLOWARD
 TBI 18-5356-16
 16 cm/6 1/4"



INGE
 TBI 18-5357-16
 16.5 cm/6 1/2"
 Blade opening 35 mm

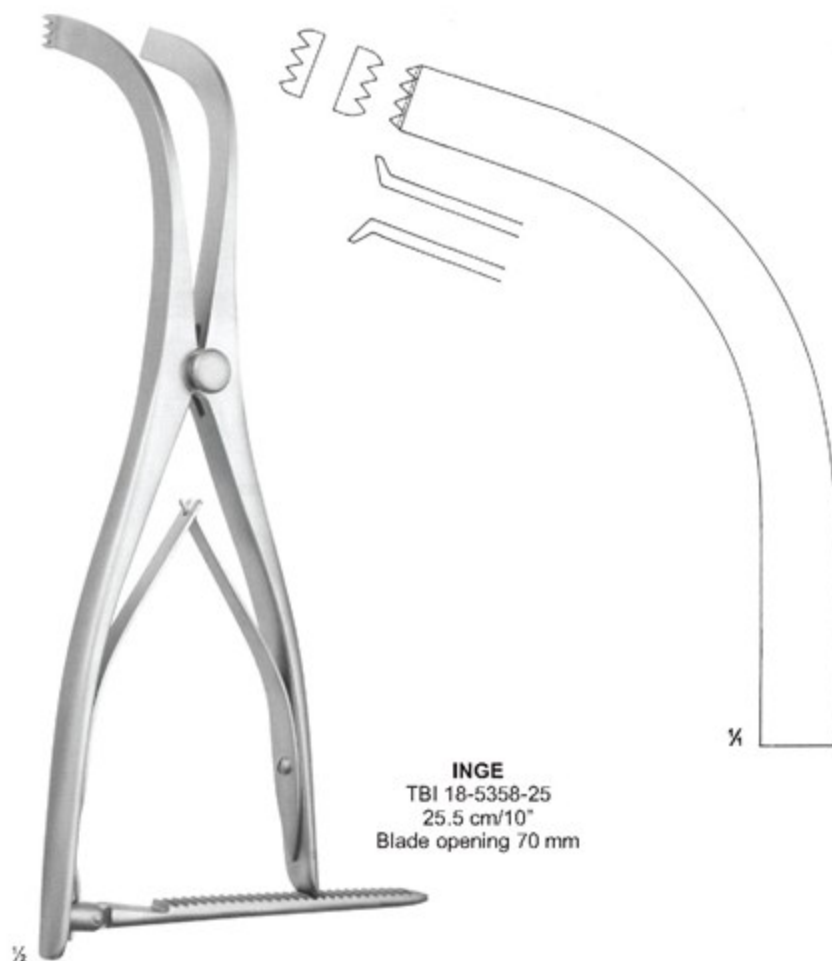

INGE
 TBI 18-5358-25
 25.5 cm/10"
 Blade opening 70 mm

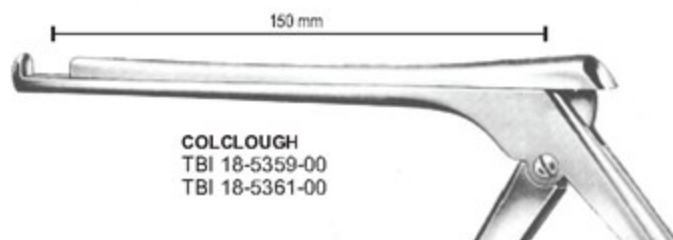

COLCLOUGH
TBI 18-5359-00
TBI 18-5361-00

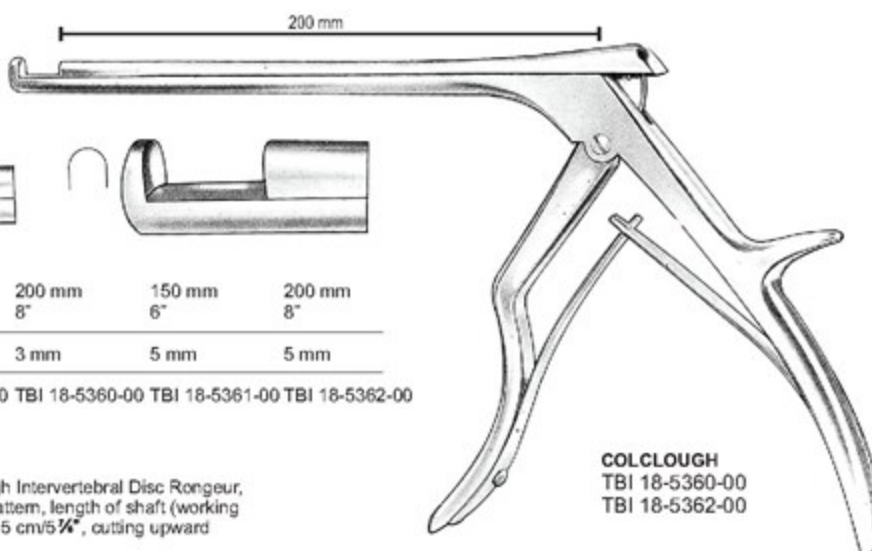

COLCLOUGH
TBI 18-5360-00
TBI 18-5362-00

Length of shaft	150 mm 6"	200 mm 8"	150 mm 6"	200 mm 8"
Width of bite	3 mm	3 mm	5 mm	5 mm
Cat. Ref.	TBI 18-5359-00	TBI 18-5360-00	TBI 18-5361-00	TBI 18-5362-00

TBI 18-5359-00 - TBI 18-5361-00 Colclough Intervertebral Disc Rongeur, heavy pattern, length of shaft (working length) 15 cm/5 7/8", cutting upward desired.

TBI 18-5360-00 - TBI 18-5362-00 Colclough Intervertebral Disc Rongeur, length of shaft (working length) 20 cm/7 7/8"

TBI 18-5362-00 - TBI 18-5363-00 Colclough Intervertebral Disc Rongeur, length of shaft (working length) 15 cm/5 7/8", cutting downward

TBI 18-5362-00 - TBI 18-5362-00 Colclough Intervertebral Disc Rongeur, length of shaft (working length) 20 cm/7 7/8"

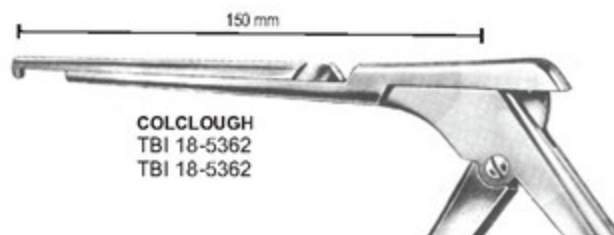

COLCLOUGH
TBI 18-5362
TBI 18-5362

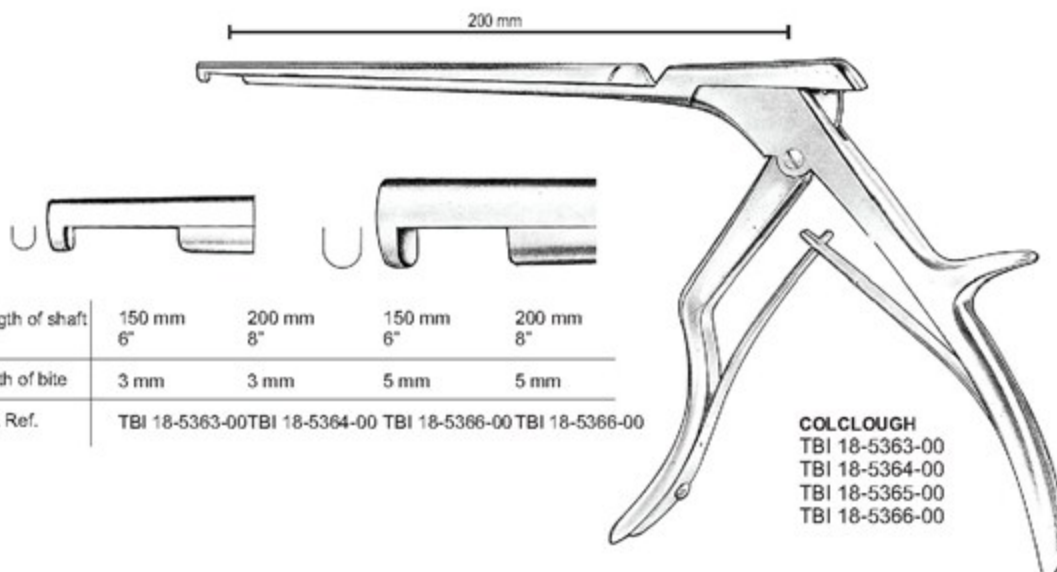

Length of shaft	150 mm 6"	200 mm 8"	150 mm 6"	200 mm 8"
Width of bite	3 mm	3 mm	5 mm	5 mm
Cat. Ref.	TBI 18-5363-00	TBI 18-5364-00	TBI 18-5365-00	TBI 18-5366-00

COLCLOUGH
TBI 18-5363-00
TBI 18-5364-00
TBI 18-5365-00
TBI 18-5366-00



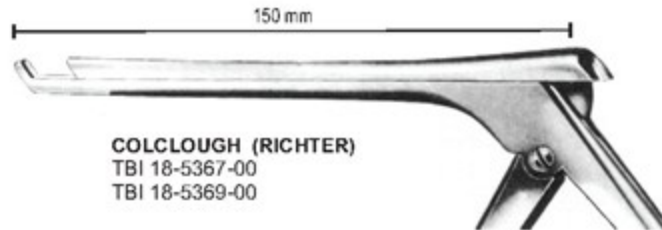

COLCLOUGH (RICHTER)
 TBI 18-5367-00
 TBI 18-5369-00

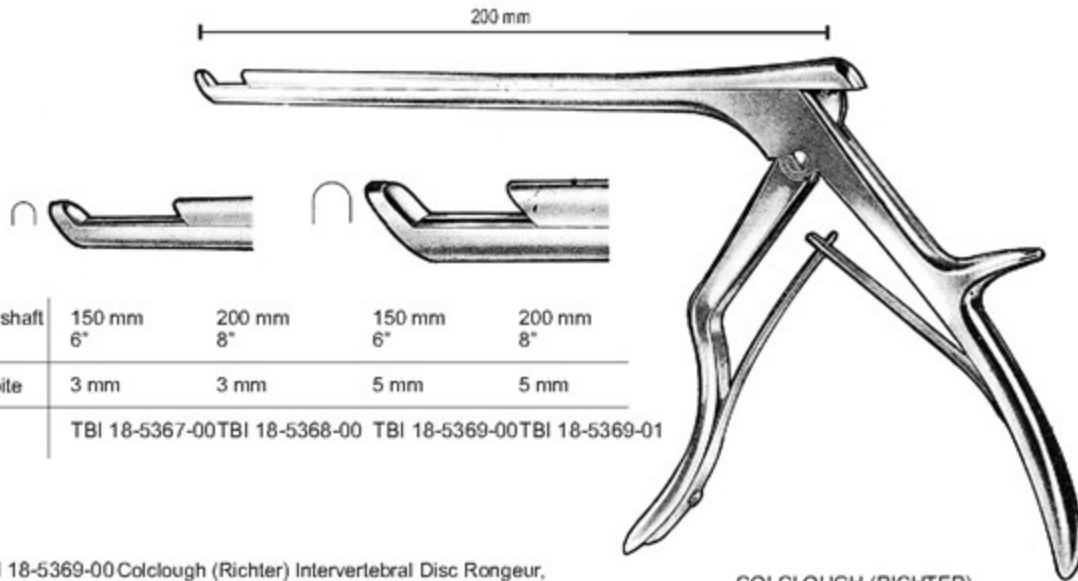

Length of shaft	150 mm 6"	200 mm 8"	150 mm 6"	200 mm 8"
Width of bite	3 mm	3 mm	5 mm	5 mm
Cat. Ref.	TBI 18-5367-00 TBI 18-5368-00 TBI 18-5369-00 TBI 18-5369-01			

COLCLOUGH (RICHTER)
 TBI 18-5368-00
 TBI 18-5369-01

TBI 18-5367-00 - TBI 18-5369-00 Colclough (Richter) Intervertebral Disc Rongeur, heavy pattern, length of shaft (working length) 15 cm/6", cutting 40° forward

TBI 18-5368-00 - TBI 18-5369-01 ditto, length of shaft (working length) 20 cm/7 7/8"

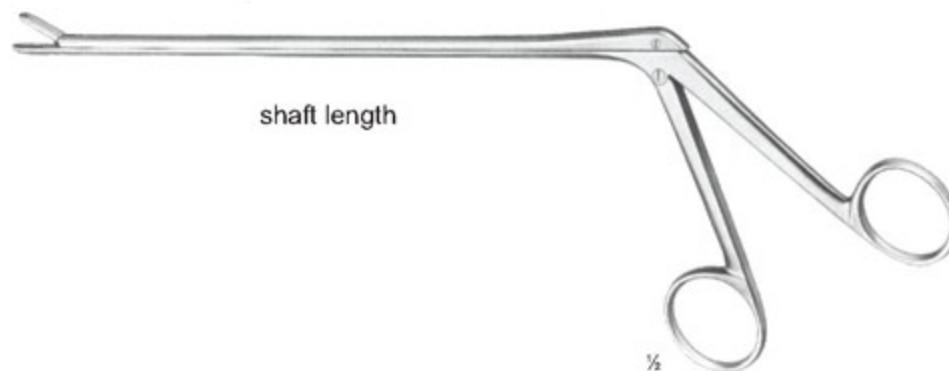

CUSHING
straight

TBI 18-5370-12 120 mm
 TBI 18-5370-15 150 mm
 TBI 18-5370-18 180 mm

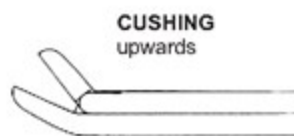

CUSHING
upwards

TBI 18-5371-12 120 mm
 TBI 18-5371-15 150 mm
 TBI 18-5371-18 180 mm

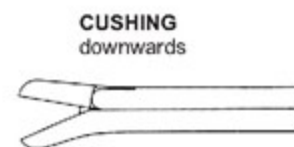

CUSHING
downwards

TBI 18-5372-12 120 mm
 TBI 18-5372-15 150 mm
 TBI 18-5372-18 180 mm



LOVE-GRUENWALD
straight

TBI 18-5373-12 120 mm
 TBI 18-5373-15 150 mm
 TBI 18-5373-18 180 mm

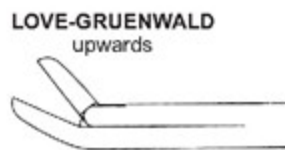

LOVE-GRUENWALD
upwards

TBI 18-5374-12 120 mm
 TBI 18-5374-15 150 mm
 TBI 18-5374-18 180 mm

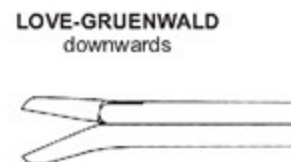

LOVE-GRUENWALD
downwards

TBI 18-5375-12 120 mm
 TBI 18-5375-15 150 mm
 TBI 18-5375-18 180 mm

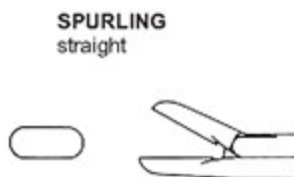

SPURLING
straight

TBI 18-5376-12 120 mm
 TBI 18-5376-15 150 mm
 TBI 18-5376-18 180 mm



SPURLING
upwards

TBI 18-5377-12 120 mm
 TBI 18-5377-15 150 mm
 TBI 18-5377-18 180 mm

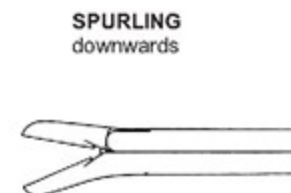

SPURLING
downwards

TBI 18-5378-12 120 mm
 TBI 18-5378-15 150 mm
 TBI 18-5378-18 180 mm



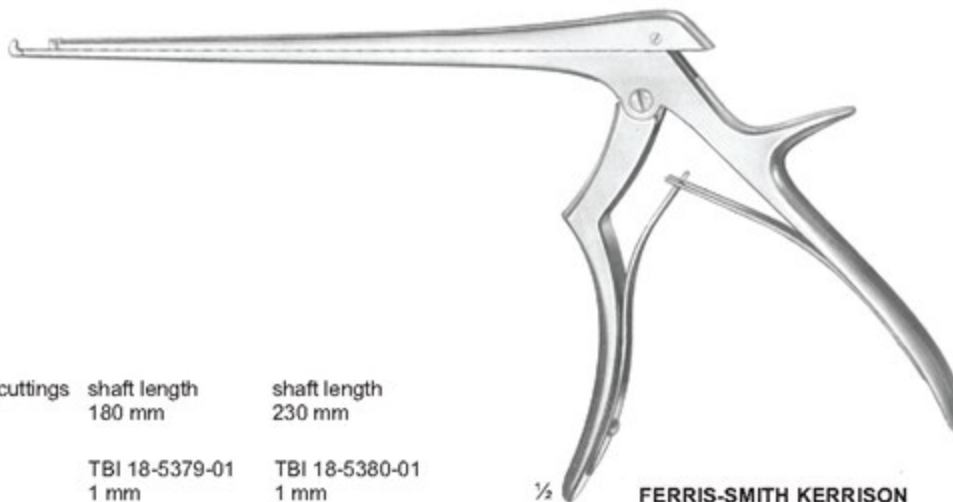

upwards cuttings	shaft length 180 mm	shaft length 230 mm
	TBI 18-5379-01 1 mm	TBI 18-5380-01 1 mm
	TBI 18-5379-02 2 mm	TBI 18-5380-02 2 mm
	TBI 18-5379-03 3 mm	TBI 18-5380-03 3 mm
	TBI 18-5379-04 4 mm	TBI 18-5380-04 4 mm
	TBI 18-5379-05 5 mm	TBI 18-5380-05 5 mm
	TBI 18-5379-06 6 mm	TBI 18-5380-06 6 mm

downwards cuttings	shaft length 180 mm
	TBI 18-5383-03 3 mm

downwards cuttings	shaft length 180 mm	shaft length 230 mm
	TBI 18-5381-01 1 mm	TBI 18-5382-01 1 mm
	TBI 18-5381-02 2 mm	TBI 18-5382-02 2 mm
	TBI 18-5383-03 3 mm	TBI 18-5382-03 3 mm
	TBI 18-5383-04 4 mm	TBI 18-5382-04 4 mm
	TBI 18-5383-05 5 mm	TBI 18-5382-05 5 mm
	TBI 18-5383-06 6 mm	TBI 18-5382-06 6 mm

upwards cuttings	shaft length 180 mm	shaft length 230 mm
	TBI 18-5384-01 1 mm	TBI 18-5385-01 1 mm
	TBI 18-5384-02 2 mm	TBI 18-5385-02 2 mm
	TBI 18-5384-03 3 mm	TBI 18-5385-03 3 mm
	TBI 18-5384-04 4 mm	TBI 18-5385-04 4 mm
	TBI 18-5384-05 5 mm	TBI 18-5385-05 5 mm
	TBI 18-5384-06 6 mm	TBI 18-5385-06 6 mm



FERRIS-SMITH KERRISON

upwards cuttings	shaft length 180 mm	shaft length 230 mm	upwards cuttings	shaft length 180 mm	shaft length 230 mm
	TBI 18-5386-1 1 mm	TBI 18-5387-1 1 mm		TBI 18-5388-1 1 mm	TBI 18-5389-1 1 mm
	TBI 18-5386-2 2 mm	TBI 18-5387-2 2 mm		TBI 18-5388-2 2 mm	TBI 18-5389-2 2 mm
	TBI 18-5386-3 3 mm	TBI 18-5387-3 3 mm		TBI 18-5388-3 3 mm	TBI 18-5389-3 3 mm
	TBI 18-5386-4 4 mm	TBI 18-5387-4 4 mm		TBI 18-5388-4 4 mm	TBI 18-5389-4 4 mm
	TBI 18-5386-5 5 mm	TBI 18-5387-5 5 mm		TBI 18-5388-5 5 mm	TBI 18-5389-5 5 mm
	TBI 18-5386-6 6 mm	TBI 18-5387-6 6 mm		TBI 18-5388-6 6 mm	TBI 18-5389-6 6 mm





TBI 18-5390-02
 Ø 2.2 mm



TBI 18-5390-03
 Ø 3.5 mm

YASARGIL



TBI 18-5391-09
 Ø 9.0 mm

LANDOLT
 Tumor grasping forceps, blunt



TBI 18-5391-07
 Ø 7.0 mm

OLDBERG

- EN** Cardiovascular Surgery
- DE** Herz- und Gefäßchirurgie
- ES** Cirugía cardiovascular

Page 388 to 498

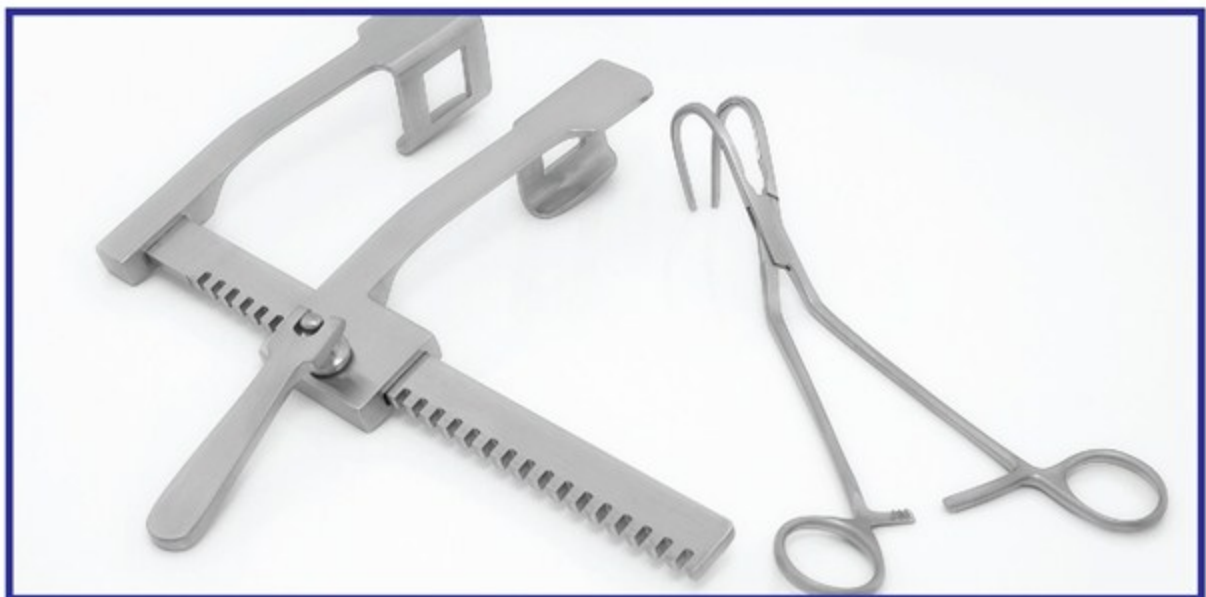



1.5 mm

TBI 19-5501-12 12.5cm
TBI 19-5501-15 15cm

DEBAKEY-ADSON



1.0 mm

TBI 19-5502-15 15.0cm
TBI 19-5502-18 18.0cm



1.2 mm

TBI 19-5503-15 15.0cm
TBI 19-5503-18 18.0cm
TBI 19-5503-24 24.0cm

DEBAKEY-GERALD



1.0mm

TBI 19-5504-18
18.0cm

DEBAKEY-CUSHING



1.0mm

TBI 19-5505-15 15.0cm
TBI 19-5505-19 19.0cm
TBI 19-5505-24 24.0cm

DEBAKEY-DIETRICH



1.5mm

TBI 19-5506-15
TBI 19-5506-19
TBI 19-5506-24



1.0mm

TBI 19-5507-15 15.0cm
TBI 19-5507-19 19.0cm
TBI 19-5507-24 24.0cm

DEBAKEY-LIGHT

Also available in titanium

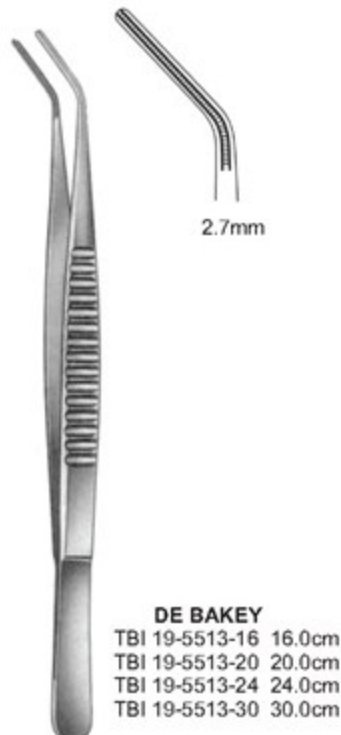
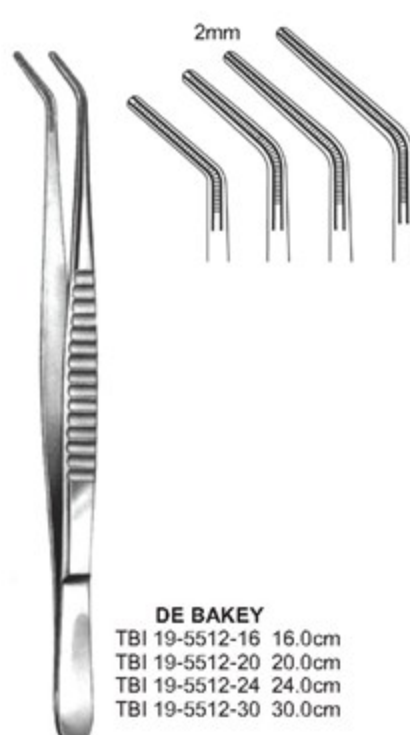
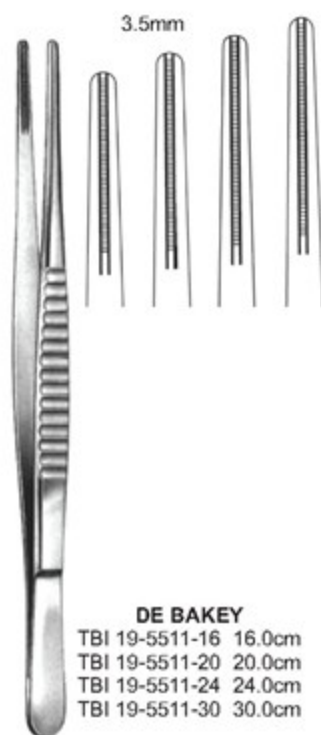
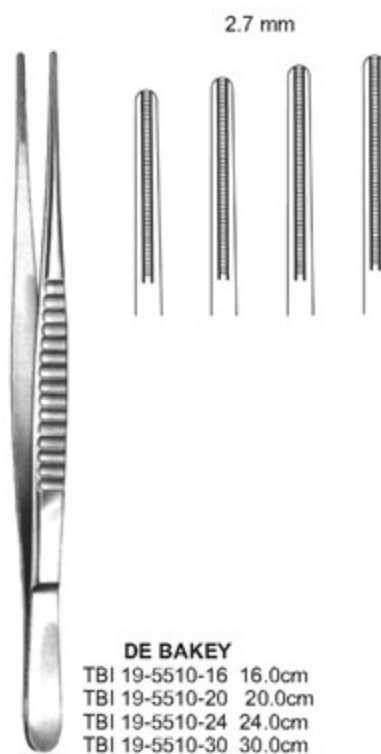
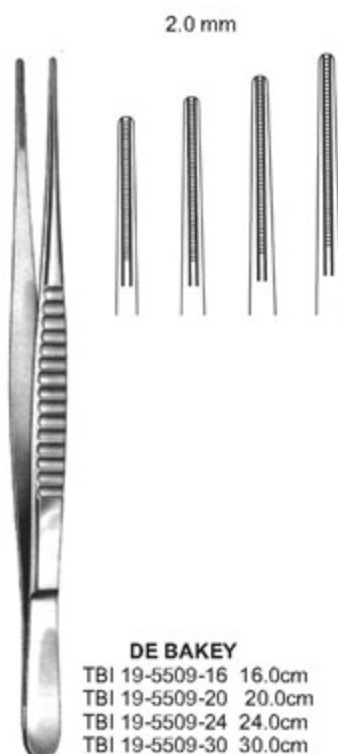

Also available in titanium

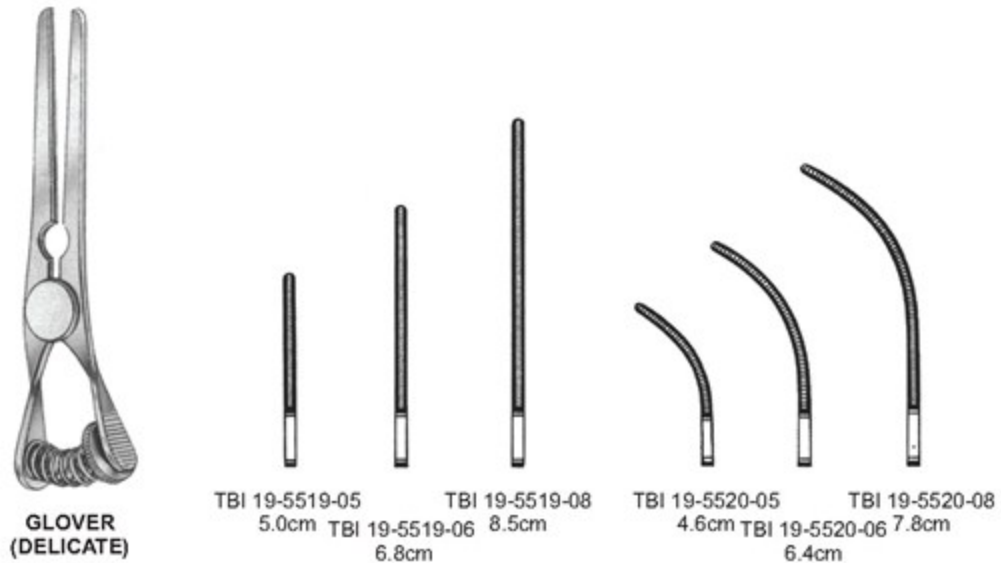
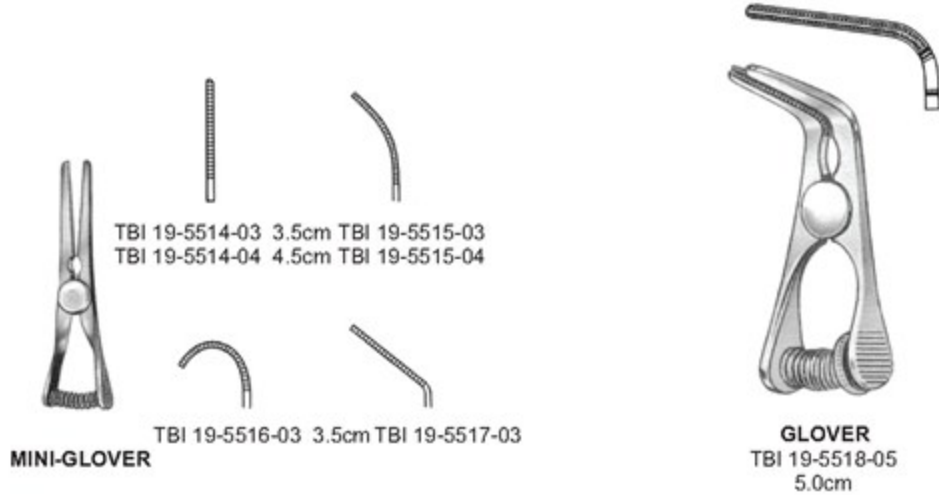

Also available in titanium

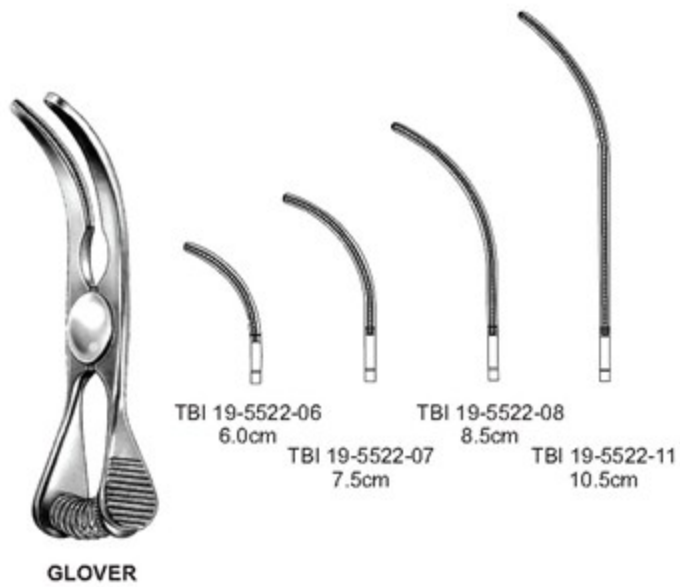
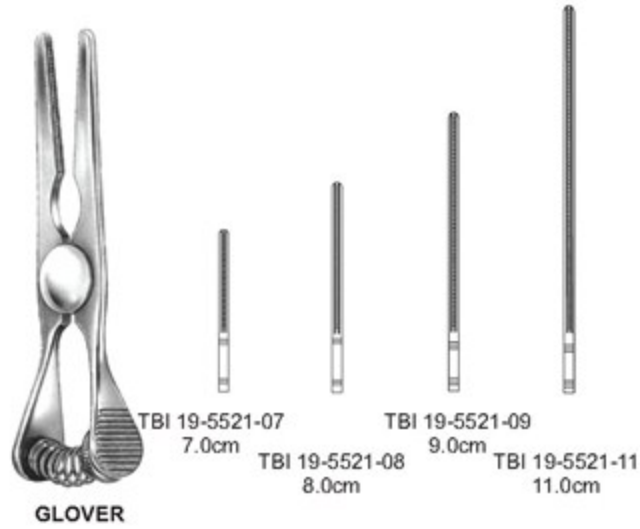

Also available in titanium



DE BAKEY



TBI 19-5529-07
7.5cm



TBI 19-5529-08
8.5cm



TBI 19-5529-10
10.5cm



TBI 19-5529-12
12.0cm



Also available in titanium

DE BAKEY



DE BAKEY



TBI 19-5530-07
7.0cm



TBI 19-5530-08
8.0cm



TBI 19-5530-10
10.0cm



TBI 19-5530-11
11.5cm



TBI 19-5531-23
23.0cm



- Atrauma Bulldog Clamps
- Atrauma Bulldogklemmen
- Atrauma Clamps Bulldog

Also available in titanium



GREGORY SOFT

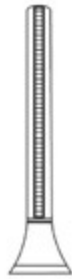

TBI 19-5532-09
9.0cm

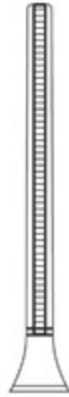

TBI 19-5532-11
11.0cm



GREGORY SOFT



TBI 19-5533-09 TBI 19-5533-11
9.0cm 11.0cm



GREGORY SOFT
11.0cm

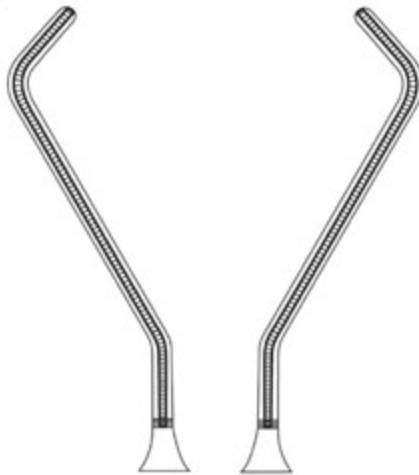

TBI 19-5534-01 TBI 19-5534-02



SANTULLI
TBI 19-5535-07
7.0cm



Also available in titanium



DE BAKEY-SATINSKY
TBI 19-5536-07
7.0cm

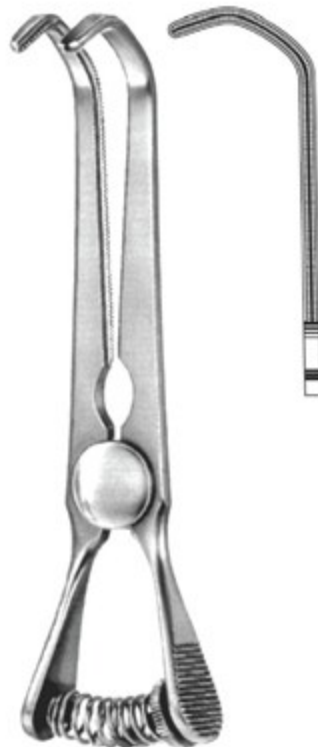

DE BAKEY-SATINSKY
TBI 19-5537-10
10.0cm



DE BAKEY-CAROTIS
TBI 19-5538-09
9.0cm



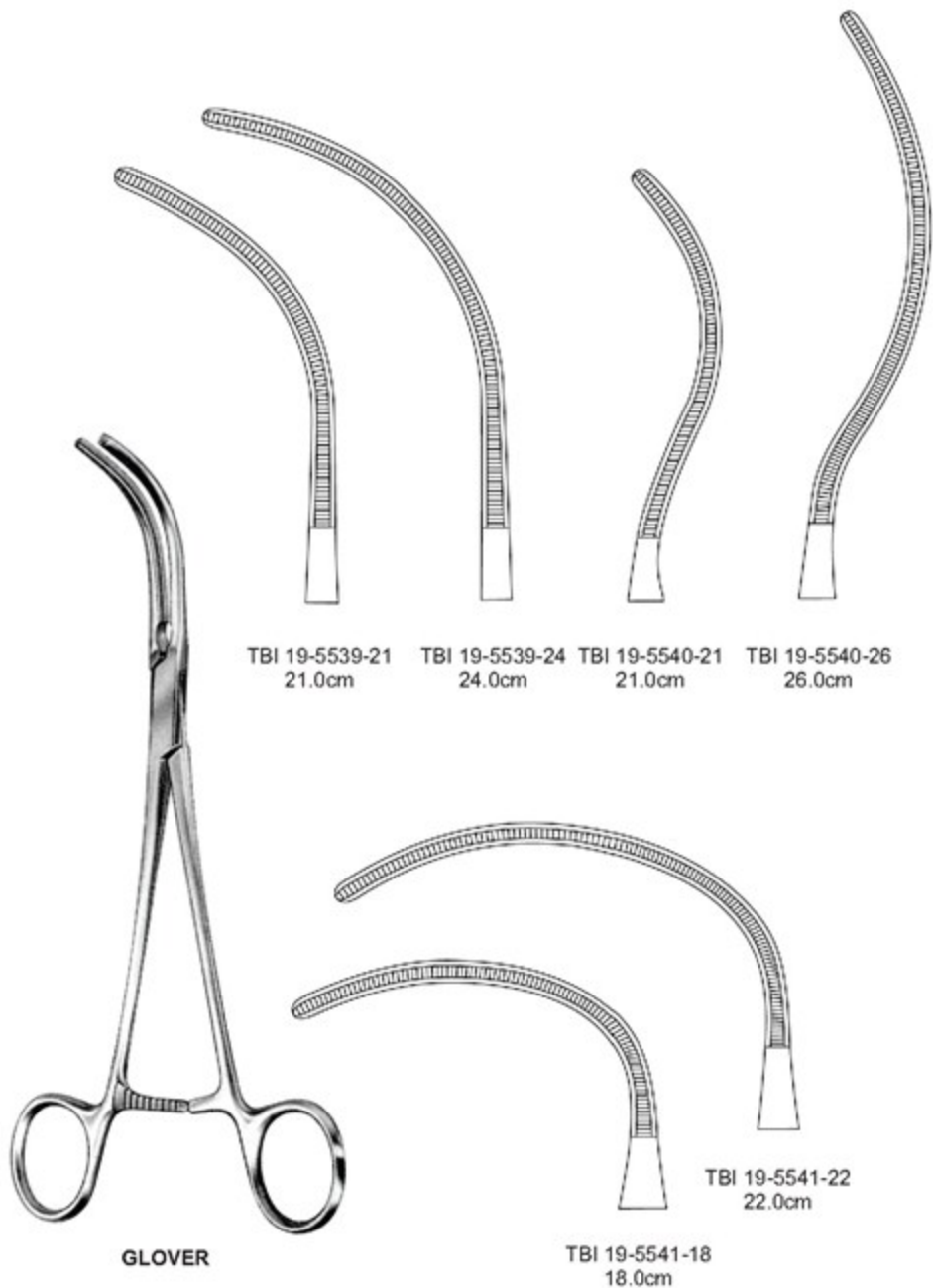

Dissecting and
Ligature Forceps



TBI 19-5543-19 19 cm/8"
 TBI 19-5543-23 23 cm/9 1/2"



TBI 19-5544-20 20 cm/8"
 TBI 19-5544-18 18 cm/7 1/2"



De Bakey



TBI 19-5545-01 19.5 cm/7 1/2"
 TBI 19-5545-02 19.5 cm/7 1/2"
 TBI 19-5545-03 19.5 cm/7 1/2"

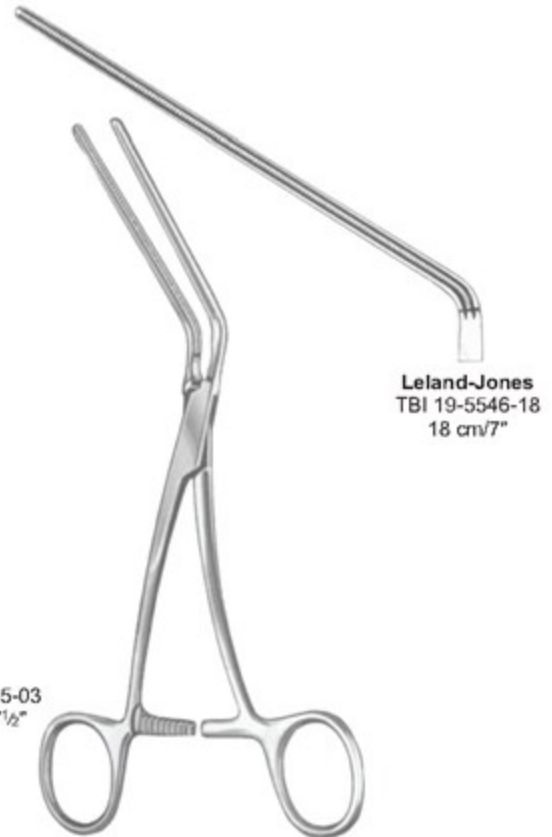



Aortic Aneurysm Clamps



De Bakey



De Bakey



TBI 19-5547-24
26 cm/10 1/2"



TBI 19-5547-27
27 cm/10 1/2"



TBI 19-5547-31
31 cm/12 1/4"



TBI 19-5547-33
33 cm/13 1/4"



De Bakey-Bainbridge



TBI 19-5548-15
15 cm/6"



TBI 19-5548-18
18 cm/7"



TBI 19-5549-15
15 cm/6"



TBI 19-5549-18
18 cm/7"



De Bakey
TBI 19-5549-20
20 cm/8"





De Bakey

Aortic Aneurysm Clamps

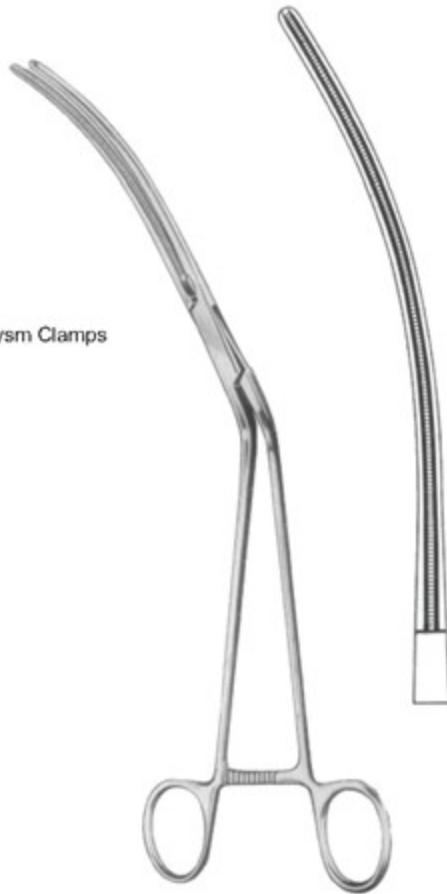

De Bakey
TBI 19-5550-28
28 cm/11"

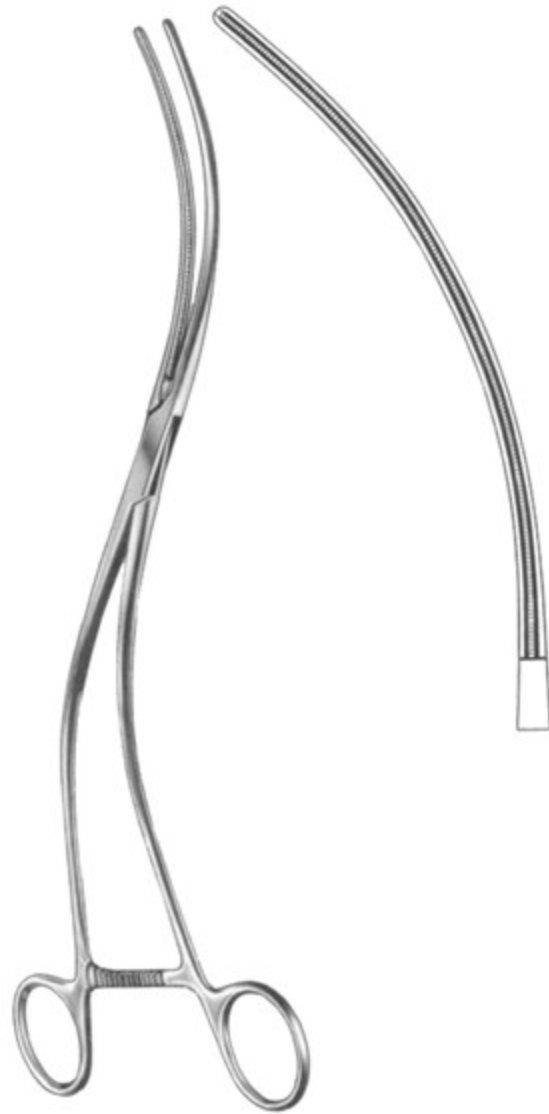

TBI 19-5551-30
30 cm/12"





De Bakey

Aortic Clamps

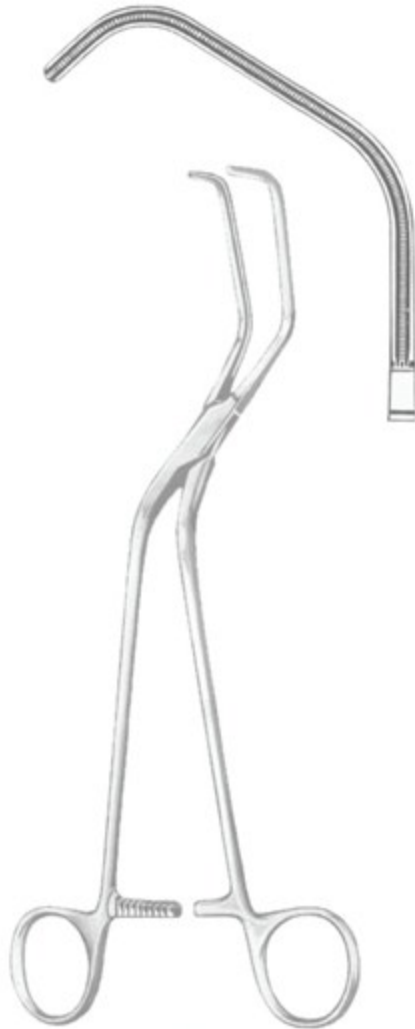

Ochsner
 TBI 19-5552-23
 23.5 cm/9¼"



Dietrich
 TBI 19-5553-21
 21 cm/8¼"



De Bakey

Auricle Clamp



Harken



TBI 19-5554-01
24 cm/9½"



TBI 19-5554-02
24 cm/9½"



TBI 19-5554-03
24 cm/9½"



TBI 19-5554-04
24 cm/9½"





De Bakey

Bronchus Clamps



Lees



Lees
TBI 19-5560-25
25 cm/10"



De Bakey

Aortic Clamp

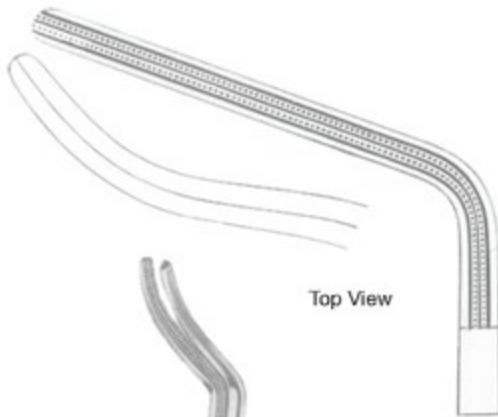

Top View



De Bakey
TBI 19-5561-27
27 cm/10½"



De Bakey
TBI 19-5562-24
24 cm/9½"

Ligature Clamps



De Bakey
TBI 19-5563-24
24 cm/9½"





De Bakey

Ligature clamp,
Aortic clamp



De Bakey
TBI 19-5564-26
26.5 cm/10½"

De Bakey-Semb
TBI 19-5564-25
25 cm/10"



De Bakey-Semb

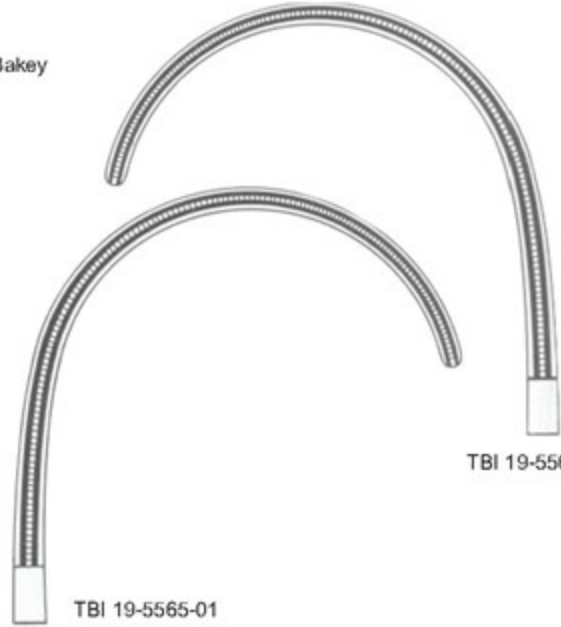

TBI 19-5565-01

TBI 19-5565-02

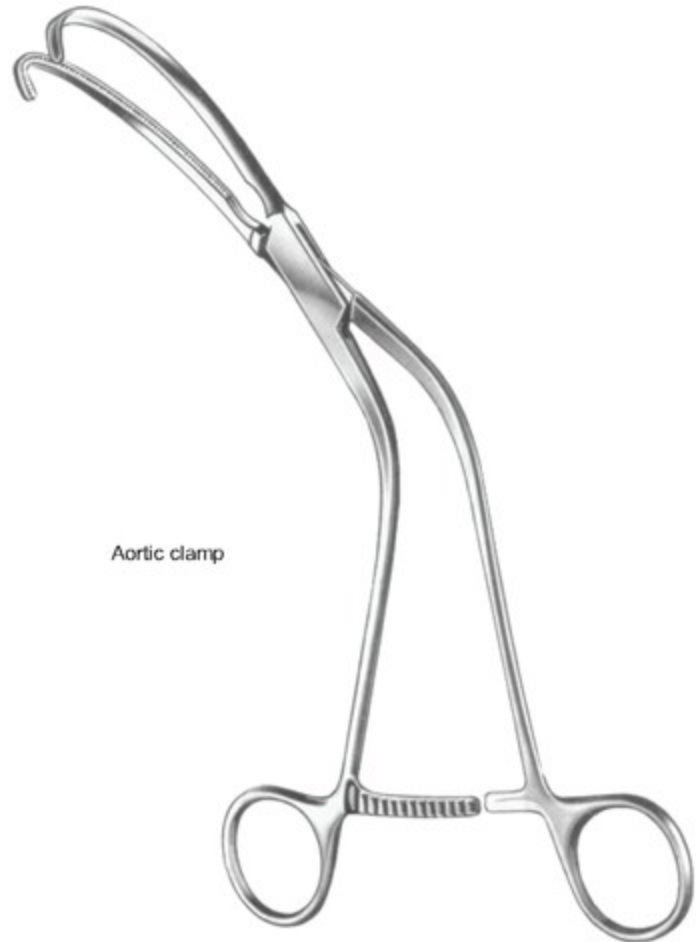

Aortic clamp

Weber
26 cm/10¼"



Satinsky/De Bakey

Tangential occlusion clamps



De Bakey



Set of 5 purchase. TBI 19-5568-00
 TBI 19-5568-20 20 cm/8"

TBI 19-5568-25 25 cm/10"

TBI 19-5568-26 26 cm/10 1/4"

TBI 19-5568-27 27 cm/10 1/2"

TBI 19-5568-28 28 cm/11"



Glover

TBI 19-5569-01 19.5 cm/7 1/4"
 TBI 19-5569-02 21.0 cm/8 1/4"

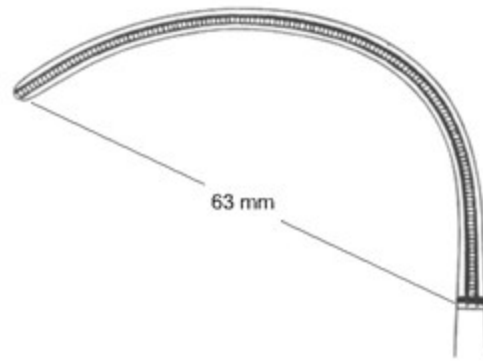

Anastomosis

63 mm

TBI 19-5569-01

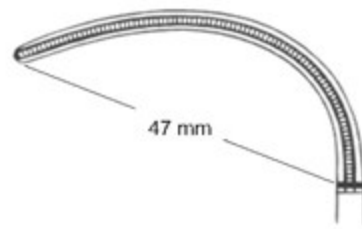

47 mm

TBI 19-5569-02





De Bakey



De Bakey
TBI 19-5570-16
16 cm/6 1/4"

Graduated

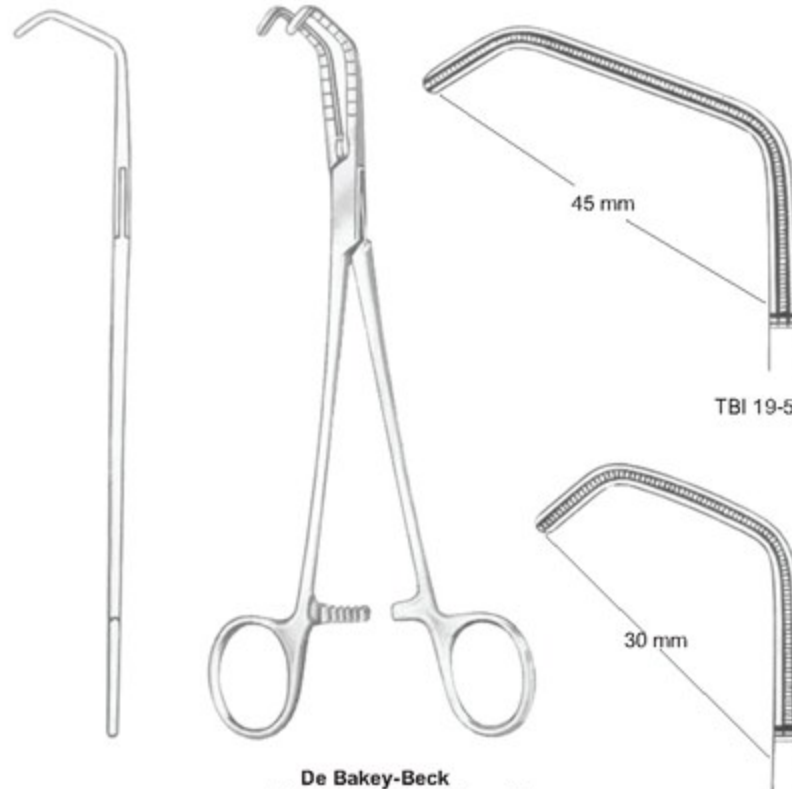

De Bakey-Beck
TBI 19-5571-01 20.5 cm/8"
TBI 19-5571-02 21.0 cm/8 1/4"

TBI 19-5571-02

TBI 19-5571-01



Lambert-Kay
21 cm/8 1/4"



Aortic anastomosis clamps

TBI 19-5572-22



De Bakey
TBI 19-5573-17
17 cm/6 3/4"



Beck
TBI 19-5574-17
17 cm/6 3/4"





TBI 19-5575-20 20 cm/8"
 TBI 19-5575-22 22 cm/8 3/4"
 TBI 19-5575-24 24 cm/9 1/2"
 TBI 19-5575-30 30.5 cm/12"

Multi purpose clamps

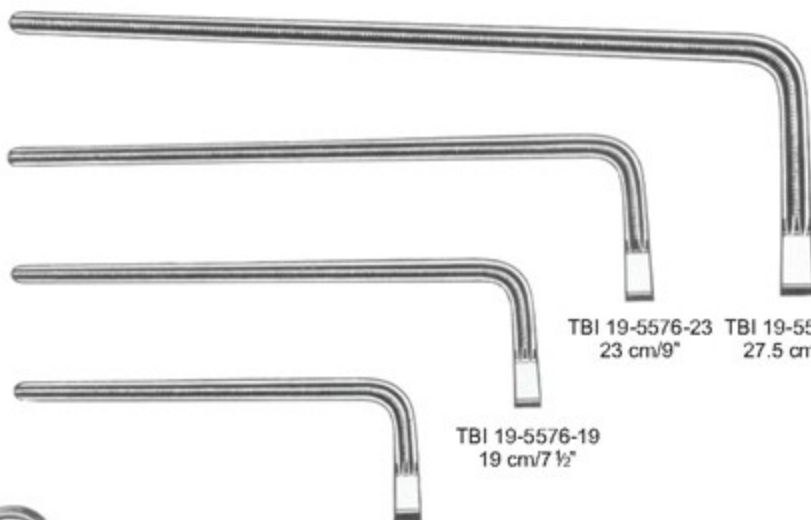
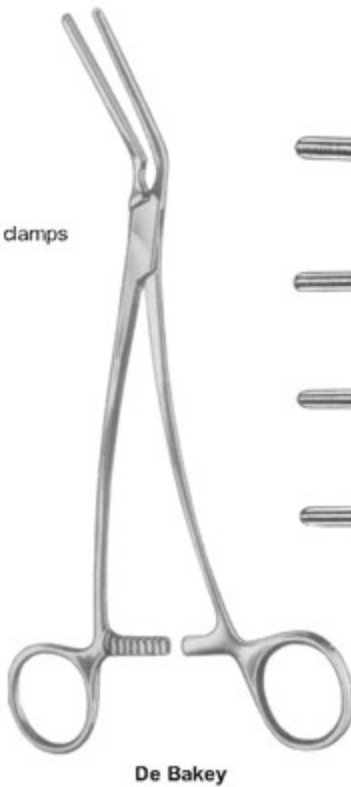

TBI 19-5576-18 18 cm/7"
 TBI 19-5576-19 19 cm/7 1/2"
 TBI 19-5576-23 23 cm/9"
 TBI 19-5576-27 27.5 cm/11"

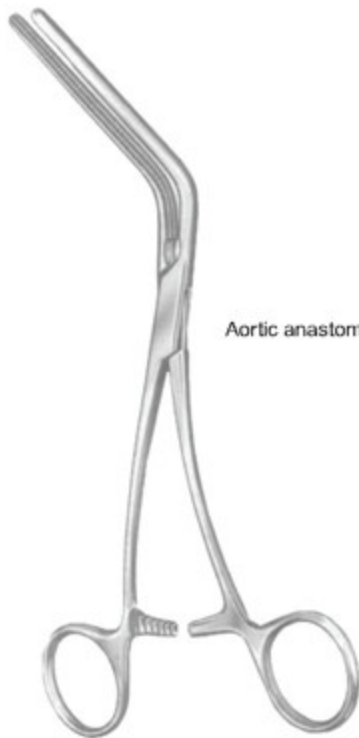

Aortic anastomosis clamps

Morris-De Bakey

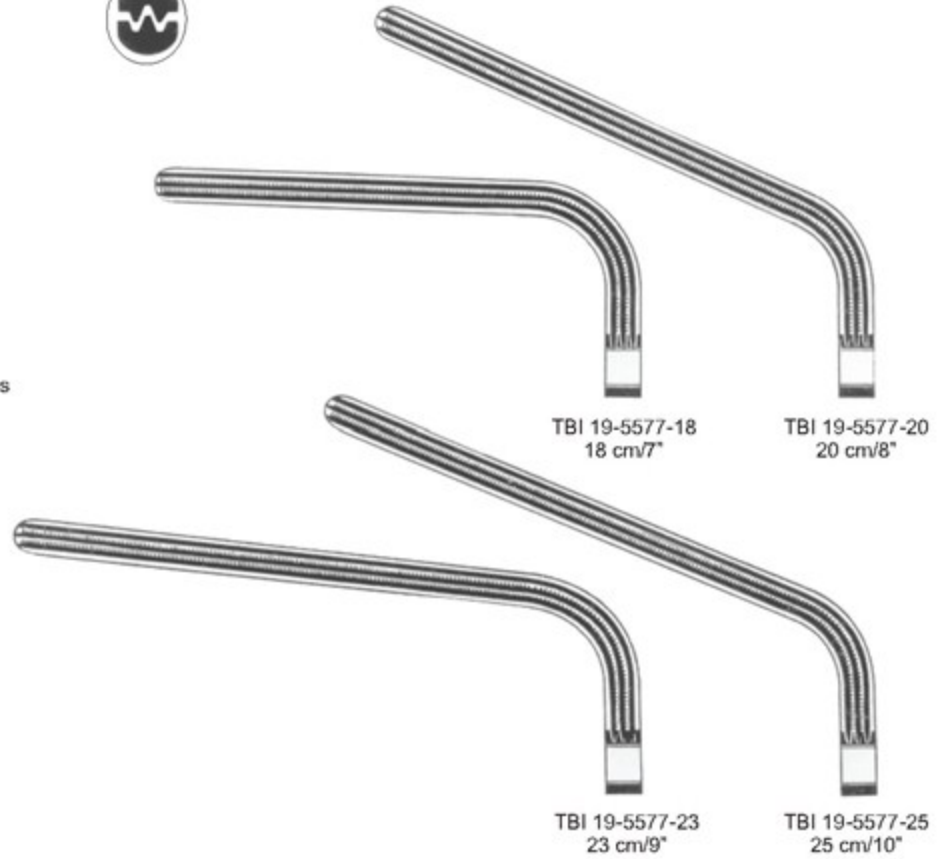

TBI 19-5577-18
18 cm/7"

TBI 19-5577-20
20 cm/8"

TBI 19-5577-23
23 cm/9"

TBI 19-5577-25
25 cm/10"



DE BAKY-PEAN

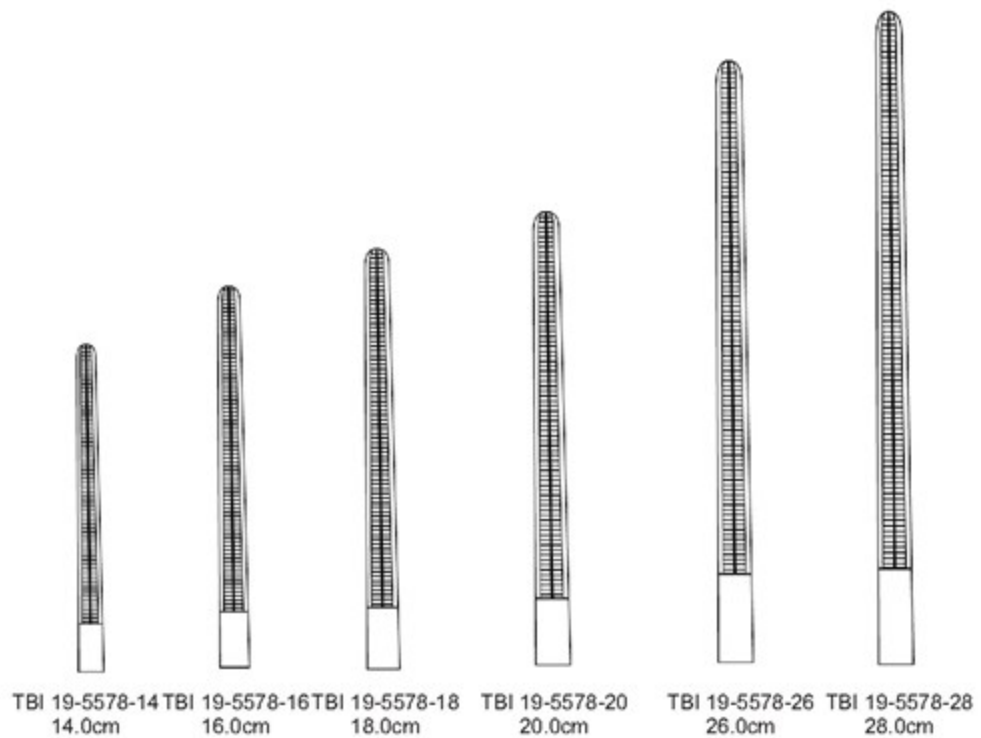

TBI 19-5578-14
14.0cm

TBI 19-5578-16
16.0cm

TBI 19-5578-18
18.0cm

TBI 19-5578-20
20.0cm

TBI 19-5578-26
26.0cm

TBI 19-5578-28
28.0cm





Aorta aneurysm clamps



De Bakey-Bahnson



De Bakey



TBI 19-5579-23
23 cm/9"



TBI 19-5579-24
24 cm/9½"



TBI 19-5579-25
25 cm/10"



DE BAKEY-PEAN



TBI 19-5580-14
14.0cm



TBI 19-5580-16
16.0cm



TBI 19-5580-18
18.0cm



TBI 19-5580-20
20.0cm



TBI 19-5580-26
26.0cm



TBI 19-5580-28
28.0cm

Multi purpose clamps



De Bakey



De Bakey-Rankin

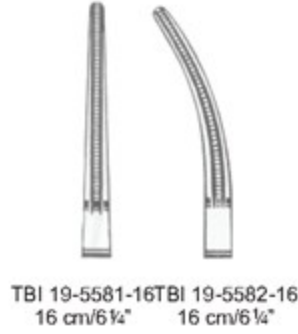

TBI 19-5581-16 16 cm/6 1/4"
 TBI 19-5582-16 16 cm/6 1/4"



Cooley



TBI 19-5583-16 16 cm/6 1/4"

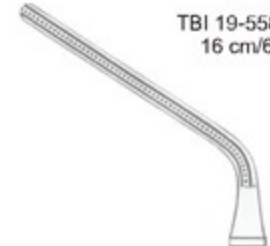

TBI 19-5583-15 15.5 cm/6"



TBI 19-5583-14 14.5 cm/5 3/4"



De Bakey
 TBI 19-5584-17 17 cm/6 3/4"



TBI 19-5585-17



TBI 19-5586-17



TBI 19-5587-17



- EN** Tonsil
- DE** Mandel
- ES** Amígdala

Page 499 to 511





Gauze Packers

Lunlatschek
TBI 20-6151-19
19 cm

Lunlatschek
TBI 20-6152-19
19 cm

Day
TBI 20-6153-21
21.5 cm

Hurd
TBI 20-6154-01
21 cm

Hurd
TBI 20-6154-02
21 cm



Nager
TBI 20-6155-24
24 cm/9½"



Falk
TBI 20-6156-24
24 cm/9½"



Falk
TBI 20-6157-24
24 cm/9½"



Claus-Eicken
TBI 20-6158-23
23 cm/9"



DURHAM
TBI 20-6159-01 25.0cm TBI 20-6159-02

TONSIL

- EN
- DE
- ES



ROTTER
 TBI 20-6160-01 26.0cm TBI 20-6160-02

Fischer
 TBI 20-6161-22
 22.5 cm/8 7/8"

Douglas
 TBI 20-6162-21
 21 cm/8 1/4"

Abraham
 TBI 20-6163-21
 21 cm/8 1/4"

Bruenings
 TBI 20-6164-23
 23 cm/9"

Tydins
 TBI 20-6165-21
 21 cm

Canfield
 TBI 20-6166-21
 21 cm/8 1/4"

Colver
 TBI 20-6167-22
 22.5cm

Dupy-Weiss
 TBI 20-6168-01 22.0cm TBI 20-6168-02

Lynch
 TBI 20-6169-20
 20.0cm

Carpenter
 TBI 20-6170-25
 25.0cm

Carpenter
 TBI 20-6171-24
 24.0cm

Marschik
 TBI 20-6172-22
 22.0cm





Negus Knot Tier and Pusher
 TBI 20-6173-20
 20cm/8"



Molison Pillar double ended
 TBI 20-6174-21
 21cm/8 1/4"



Gwynee Evans Dissector double ended
 TBI 20-6175-06
 6mm, 20cm/8"
 TBI 20-6175-08
 8mm, 20cm/8"



Hurd
 TBI 20-6176-22
 22.5 cm/8 7/8"



Yankauer
 TBI 20-6177-21
 21 cm/8 1/4"



TBI 20-6178-01



Henke
 23 cm/9"
 TBI 20-6178-02



Nager
 TBI 20-6179-23
 23 cm/9"



Wide
 TBI 20-6180-18 18 mm
 TBI 20-6180-20 20 mm
 TBI 20-6180-22 22 mm

Love
 23 cm/9"



Haslinger
 TBI 20-6181-16



Hofer
 TBI 20-6182-24
 24 cm/9 1/2"

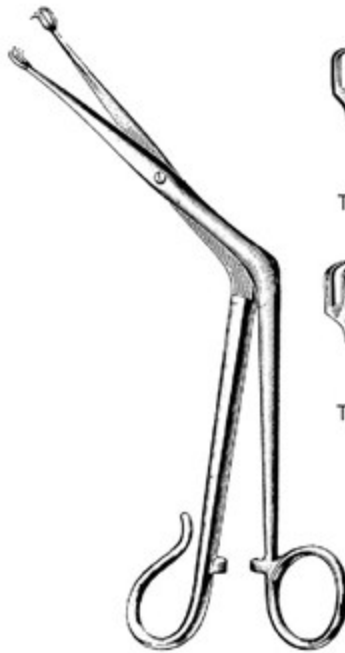

TIVNEN-TYDING
 21.0cm



Fig. 1
 TBI 20-6183-01



Fig. 2
 TBI 20-6183-02



MUSEUX
 TBI 20-6184-20
 20.0cm



MUSEUX
 TBI 20-6185-20
 20.0cm



BALLENGER
 TBI 20-6186-21
 21.5cm



WHITE
 TBI 20-6187-18 18.0cm
 TBI 20-6187-23 23.0cm



TBI 20-6188-01



TBI 20-6188-02

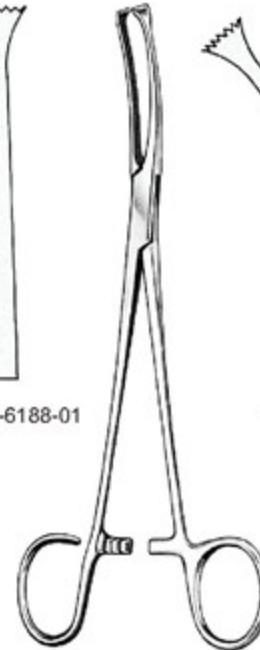

COLVER
 19.0cm



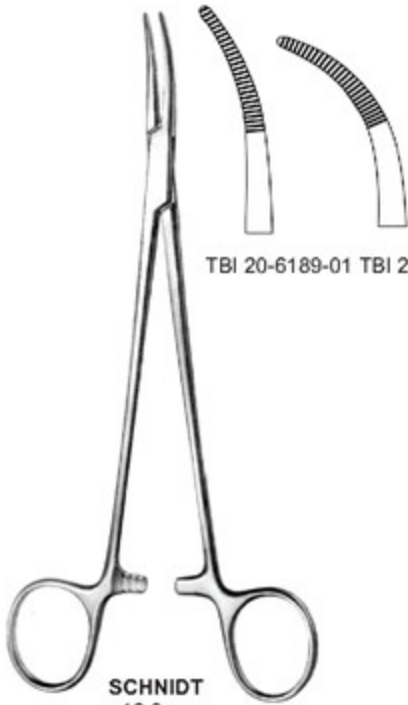

TBI 20-6189-01 TBI 20-6189-02

SCHNIDT
19.0cm

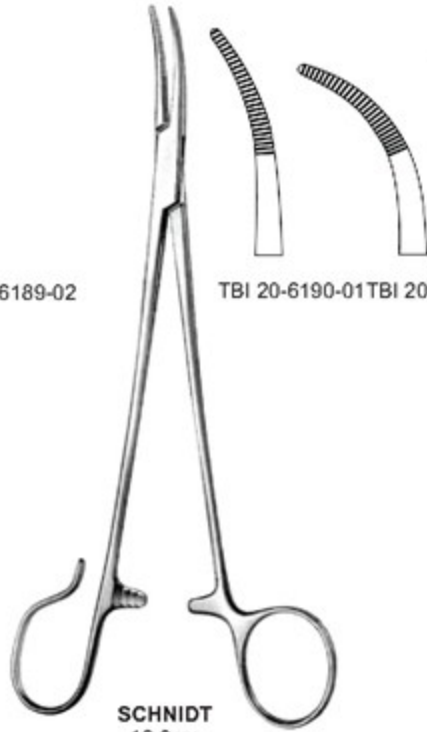

TBI 20-6190-01 TBI 20-6190-02

SCHNIDT
19.0cm

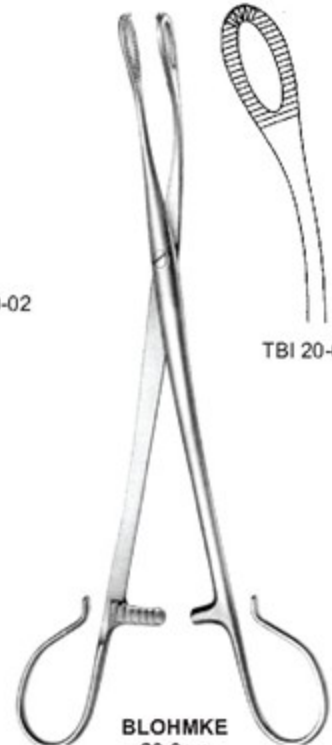

TBI 20-6191-20

BLOHMKE
20.0cm



DENIS-BROWNE
TBI 20-6192-18 18.0cm
TBI 20-6192-21 21.0cm



McWHOPTER-LOTHROP
TBI 20-6193-18
18.0cm

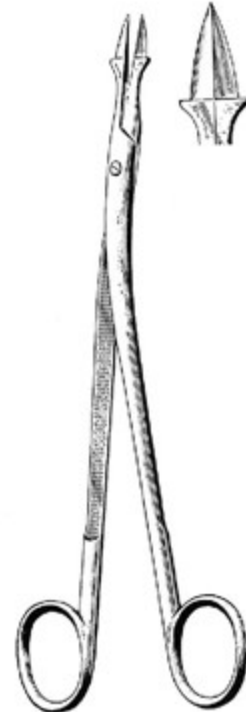

THILENIUS
TBI 20-6194-20
20.0cm

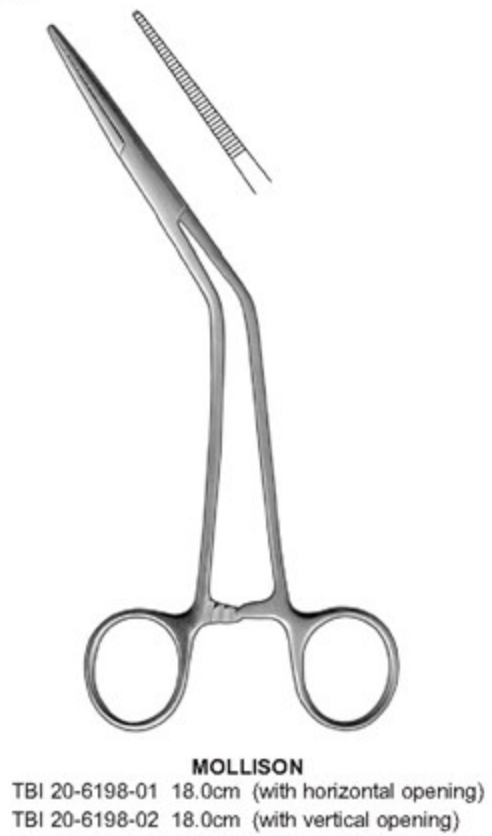
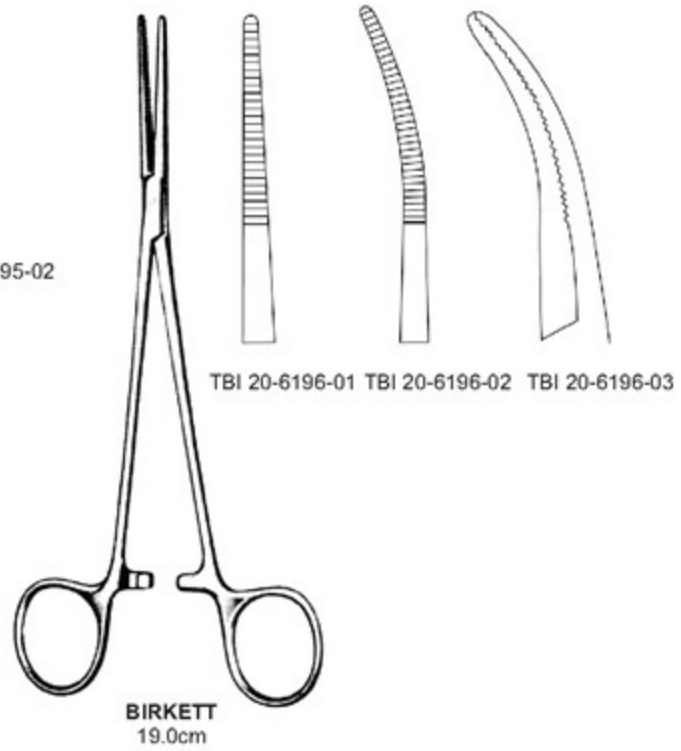



Eves
TBI 20-6199-28
28 cm/11"



Eves
TBI 20-6200-28
28 cm/11"



Bruenings
TBI 20-6201-28
28 cm/11"

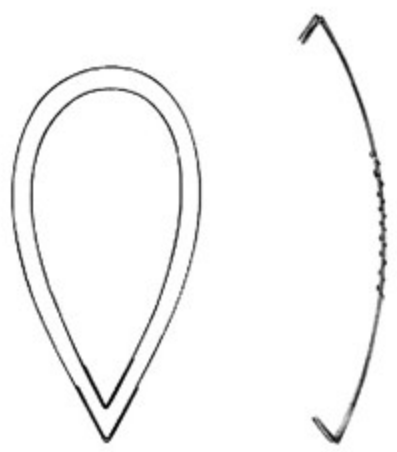

TBI 20-6202-40 40mm TBI 20-6203-03 0.3mm Ø
TBI 20-6202-50 50mm

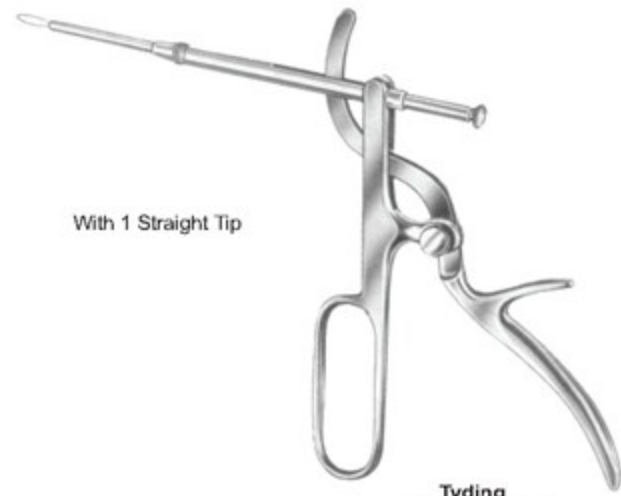

With 1 Straight Tip

Tyding
TBI 20-6204-00



TBI 20-6205-01 TBI 20-6205-02 TBI 20-6205-03



Sluder-Ballenger
 Complete, With 3 Tips
 TBI 20-6205-00



Corwin
 TBI 20-6206-14
 14 cm/5 1/2"



Tonsil Punch Forceps

TBI 20-6207-13 13 mm/O
 TBI 20-6207-15 15 mm/O
 TBI 20-6207-17 17 mm/O

Hartmann



Luc Forceps
 TBI 20-6208-01 Small
 TBI 20-6208-02 Medium
 TBI 20-6208-03 Large
 20cm/8"





Waugh Dissecting Forcep
 TBI 20-6209-20
 1 x 2 teeth
 20cm/8"



Waugh Dissecting Forcep
 TBI 20-6210-20
 serrated
 20cm/8"



Metzenbaum Scissor Cvd.
 TBI 20-6211-18
 18cm/7"

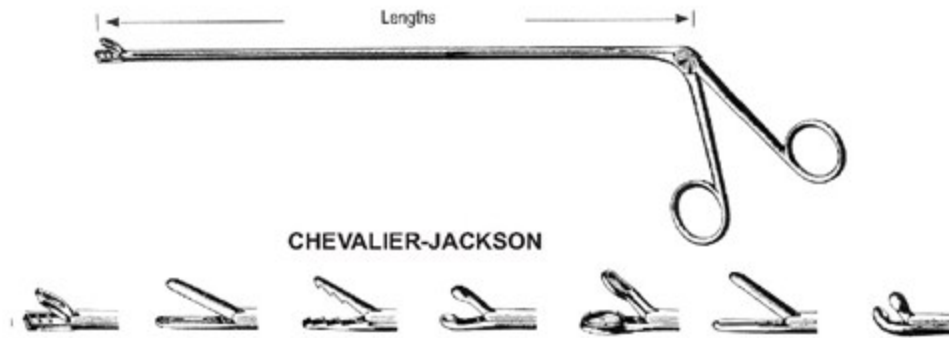

CHEVALIER-JACKSON

30.0cm	TBI 20-6212-30	TBI 20-6213-30	TBI 20-6214-30	TBI 20-6215-30	TBI 20-6216-30	TBI 20-6217-30	TBI 20-6218-30
40.0cm	TBI 20-6212-40	TBI 20-6213-40	TBI 20-6214-40	TBI 20-6215-40	TBI 20-6216-40	TBI 20-6217-40	TBI 20-6218-40
50.0cm	TBI 20-6212-50	TBI 20-6213-50	TBI 20-6214-50	TBI 20-6215-50	TBI 20-6216-50	TBI 20-6217-50	TBI 20-6218-50
60.0cm	TBI 20-6212-60	TBI 20-6213-60	TBI 20-6214-60	TBI 20-6215-60	TBI 20-6216-60	TBI 20-6217-60	TBI 20-6218-60



HUBER
TBI 20-6219-00



BRUENINGS (straight)
 TBI 20-6219-20 20.0cm
 TBI 20-6219-30 30.0cm
 TBI 20-6219-40 40.0cm
 TBI 20-6219-50 50.0cm
 TBI 20-6219-60 60.0cm



BRUENINGS
TBI 20-6220-00



BRUENINGS
TBI 20-6221-20
20.0cm





FRAENKEL
TBI 20-6222-00



BARACANI
TBI 20-6223-00



SEIFFERT
TBI 20-6224-00



FRAENKEL
TBI 20-6225-00



BRUENINGS
TBI 20-6226-01
TBI 20-6226-02



BRUENINGS
TBI 20-6227-01
TBI 20-6227-02



LANGE
TBI 20-6228-00



KRAUSE
TBI 20-6229-01
TBI 20-6229-02



SCHUMACHER
TBI 20-6230-00



CORDES
TBI 20-6231-01
TBI 20-6231-02



CORDES
TBI 20-6232-00



ROSENBERG
TBI 20-6233-00



KRAUSE
TBI 20-6234-00



CORDES
TBI 20-6235-01
TBI 20-6235-02
TBI 20-6235-03
TBI 20-6235-04



SCHEINMANN
TBI 20-6236-00



SCHEINMANN
TBI 20-6237-00



TBI 20-6238-11



TBI 20-6239-10



TBI 20-6240-11



TBI 20-6241-12



TBI 20-6242-00



MICHEL
 25.0cm



TBI 20-6243-12 TBI 20-6243-14 TBI 20-6243-16 TBI 20-6243-18



- | | | |
|----------------|----------------|----------------|
| TBI 20-6244-08 | fig.00, 8mm Ø | TBI 20-6245-08 |
| TBI 20-6244-10 | fig.0, 10mm Ø | TBI 20-6245-10 |
| TBI 20-6244-12 | fig.1, 12mm Ø | TBI 20-6245-12 |
| TBI 20-6244-14 | fig.2, 14mm Ø | TBI 20-6245-14 |
| TBI 20-6244-16 | fig.3, 16mm Ø | TBI 20-6245-16 |
| TBI 20-6244-18 | fig.4, 18mm Ø | TBI 20-6245-18 |
| TBI 20-6244-20 | fig.5, 20mm Ø | TBI 20-6245-20 |
| TBI 20-6244-22 | fig.6, 22mm Ø | TBI 20-6245-22 |
| TBI 20-6244-24 | fig.7, 24mm Ø | TBI 20-6245-24 |
| TBI 20-6244-26 | fig.8, 26mm Ø | TBI 20-6245-26 |
| TBI 20-6244-28 | fig.9, 28mm Ø | TBI 20-6245-28 |
| TBI 20-6244-30 | fig.10, 30mm Ø | TBI 20-6245-30 |





TBI 20-6246-01



TBI 20-6246-02



TBI 20-6246-03



TBI 20-6246-04



JURASZ
23.0cm

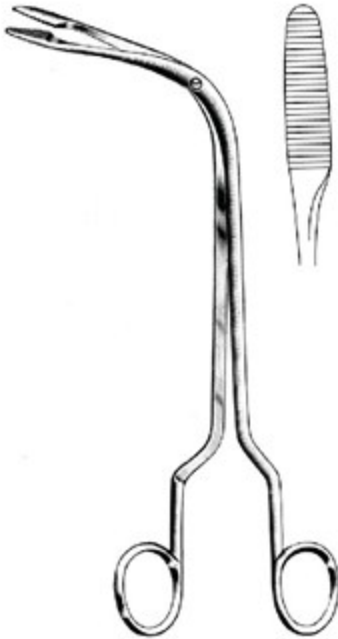

FRAENKEL
TBI 20-6247-19
19.0cm



JACKSON
22.0cm



TBI 20-6248-22 TBI 20-6248-22



REICHERT
TBI 20-6249-24
24.0cm

EN Otolology

DE Otologie

ES Otología

Page 512 to 540



**TROELTSCH**

TBI 21-6301-00 set/3
 TBI 21-6301-01 6mm Ø, Fig. 1
 TBI 21-6301-02 7mm Ø, Fig. 2
 TBI 21-6301-03 8mm Ø, Fig. 3

**HARTMANN (for children)**

TBI 21-6302-00 set/3
 TBI 21-6302-00 3mm Ø, Fig. 1
 TBI 21-6302-01 4mm Ø, Fig. 1
 TBI 21-6302-02 5mm Ø, Fig. 2

**HARTMANN (for adults)**

TBI 21-6303-00 set/4
 TBI 21-6303-01 4.0mm Ø, Fig. 1
 TBI 21-6303-02 5.0mm Ø, Fig. 2
 TBI 21-6303-03 6.0mm Ø, Fig. 3
 TBI 21-6303-04 7.5mm Ø, Fig. 4

**TOYNBEE (for adults)**

TBI 21-6304-00 set/4
 TBI 21-6304-01 4mm Ø, Fig. 1
 TBI 21-6304-02 5mm Ø, Fig. 2
 TBI 21-6304-03 6mm Ø, Fig. 3
 TBI 21-6304-04 7mm Ø, Fig. 4

**GRUBER (for adults)**

TBI 21-6305-00 set/4
 TBI 21-6305-01 4.5mm Ø, Fig. 1
 TBI 21-6305-02 5.5mm Ø, Fig. 2
 TBI 21-6305-03 6.5mm Ø, Fig. 3
 TBI 21-6305-04 7.5mm Ø, Fig. 4

**GRUBER**

TBI 21-6306-00 set/4
 TBI 21-6306-01 4.5mm Ø, Fig. 1
 TBI 21-6306-02 5.5mm Ø, Fig. 2
 TBI 21-6306-03 6.5mm Ø, Fig. 3
 TBI 21-6306-04 7.5mm Ø, Fig. 4

**GRUBER**

TBI 21-6307-00 set/4
 TBI 21-6307-01 4.5mm Ø, Fig. 1
 TBI 21-6307-02 5.5mm Ø, Fig. 2
 TBI 21-6307-03 6.5mm Ø, Fig. 3
 TBI 21-6307-04 7.5mm Ø, Fig. 4

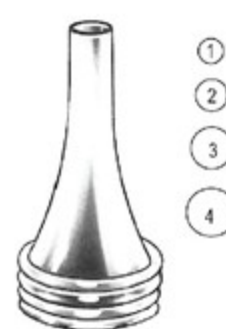
**POLITZER**

TBI 21-6308-00 set/4
 TBI 21-6308-01 3.0mm Ø, Fig. 1
 TBI 21-6308-02 4.5mm Ø, Fig. 2
 TBI 21-6308-03 5.5mm Ø, Fig. 3
 TBI 21-6308-04 6.5mm Ø, Fig. 4

**ERHARDT**

TBI 21-6309-00 set/3
 TBI 21-6309-01 4.5mm Ø, Fig. 1
 TBI 21-6309-02 5.5mm Ø, Fig. 2
 TBI 21-6309-03 6.5mm Ø, Fig. 3

**PRITCHARD**

TBI 21-6310-00 set/3
 TBI 21-6310-01 4.5mm Ø, Fig. 1
 TBI 21-6310-02 6.5mm Ø, Fig. 2
 TBI 21-6310-03 7.5mm Ø, Fig. 3

**BOUCHERON**

TBI 21-6311-00 set/5
 TBI 21-6311-01 4.0mm Ø, Fig. 1
 TBI 21-6311-02 5.0mm Ø, Fig. 2
 TBI 21-6311-03 6.0mm Ø, Fig. 3
 TBI 21-6311-04 7.0mm Ø, Fig. 4
 TBI 21-6311-05 8.0mm Ø, Fig. 5

**ZÖLLNER**

TBI 21-6312-00 set/6
 TBI 21-6312-01 5.5x6.5mm Ø, Fig. 1
 TBI 21-6312-02 6.5x7.5mm Ø, Fig. 2
 TBI 21-6312-03 7.5x8.5mm Ø, Fig. 3
 TBI 21-6312-04 8.5x9.5mm Ø, Fig. 4
 TBI 21-6312-05 9.5x10.5mm Ø, Fig. 5
 TBI 21-6312-06 10.5x11.5mm Ø, Fig. 6

**RICHNAU HOLMGREN**

TBI 21-6314-02 Ø 2mm
 TBI 21-6314-03 Ø 3mm
 TBI 21-6314-04 Ø 4mm
 TBI 21-6314-05 Ø 5mm
 TBI 21-6314-06 Ø 6mm



1
6.5mm Ø



TBI 21-6315-01

2
7mm Ø



TBI 21-6315-02

3
8mm Ø



TBI 21-6315-03

1
6mm Ø



TBI 21-6316-01

2
7.5mm Ø



TBI 21-6316-02

3
8.2mm Ø



TBI 21-6316-03

4
10mm Ø



TBI 21-6316-04

**SIEGLE**

TBI 21-6315-00 set
 TBI 21-6315-04 otoscope
 TBI 21-6315-05 rubber bulb
 TBI 21-6315-01,02,03 speculas

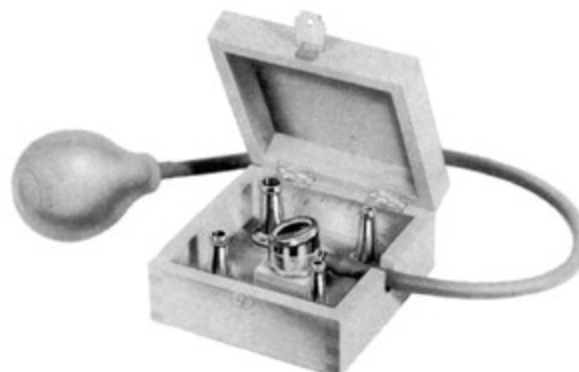

TBI 21-6316-00 Compl.

**BRUENINGS**

TBI 21-6316-05 set of 4 speculas
 TBI 21-6316-06 rubber bulb
 TBI 21-6316-07 wooden case only
 TBI 21-6316-10 otoscope

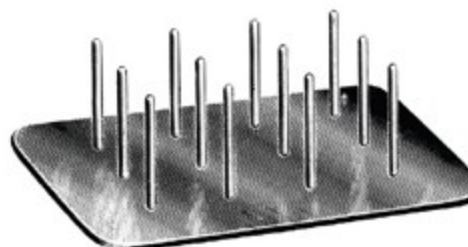

TBI 21-6317-01
 support for specula

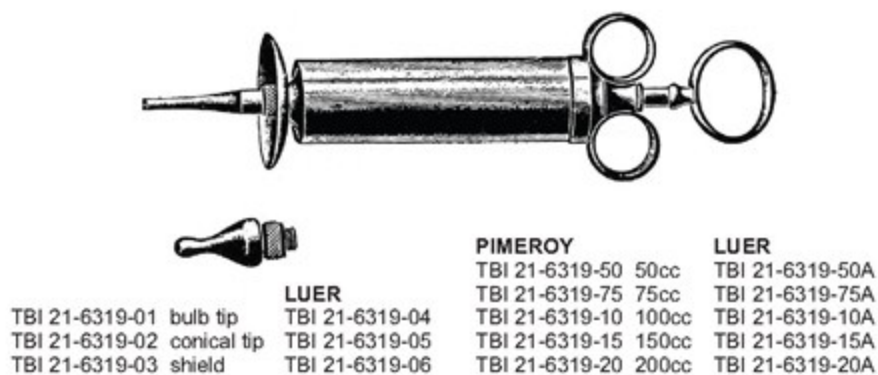



Tuning Forks

					
Hartmann	Lucae	French Hartmann	Lucae C 128	Hartmann C 128	Rydel-Seiffer
16		TBI 21-6322-16			TBI 21-6325-00
32		TBI 21-6322-32	Variable up to h (Engl. B)		C 64/C 128
64		TBI 21-6322-01	TBI 21-6323-00	TBI 21-6324-00	
128	TBI 21-6320-00	TBI 21-6321-00			
256	TBI 21-6320-01	TBI 21-6321-01			
512	TBI 21-6320-02	TBI 21-6321-02			
1024	TBI 21-6320-03	TBI 21-6321-03			
2048	TBI 21-6320-04	TBI 21-6321-04			
4096	TBI 21-6320-05	TBI 21-6321-05			

						
TBI 21-6327-01	TBI 21-6327-02	TBI 21-6327-03	TBI 21-6327-04	TBI 21-6327-05	TBI 21-6327-06	TBI 21-6327-07
C 64	C 128	C 256	C 512 aluminum	C 1024 aluminum	C 2048 aluminum	C 4096 aluminum



Tuning Fork for neuro-
logical examination, with
percussion hammer, pin
wheel, brush and needle
TBI 21-6326-00

With Clamps = C 64
Without Clamps = C 128

TONSIL



TROELTSCH
 TBI 21-6328-01 Fig. 1
 TBI 21-6328-02 Fig. 2
 TBI 21-6328-03 Fig. 3
 TBI 21-6328-04 Fig. 4
 TBI 21-6328-05 Fig. 5



LUCAE
 TBI 21-6329-01 Fig. 1
 TBI 21-6329-02 Fig. 2
 TBI 21-6329-03 Fig. 3
 TBI 21-6329-04 Fig. 4
 TBI 21-6329-05 Fig. 5



WOAKES
 TBI 21-6330-01



HARTMANN
 TBI 21-6331-02 Fig. 2
 TBI 21-6331-03 Fig. 3
 TBI 21-6331-04 Fig. 4



HARTMANN
 TBI 21-6332-00 Fig. 0
 TBI 21-6332-01 Fig. 1
 TBI 21-6332-02 Fig. 2
 TBI 21-6332-03 Fig. 3
 TBI 21-6332-04 Fig. 4
 TBI 21-6332-05 Fig. 5



HARTMANN
 TBI 21-6333-00 Fig. 0
 TBI 21-6333-01 Fig. 1
 TBI 21-6333-02 Fig. 2
 TBI 21-6333-03 Fig. 3
 TBI 21-6333-04 Fig. 4
 TBI 21-6333-05 Fig. 5



ITARD
 TBI 21-6334-01 Fig. 1
 TBI 21-6334-02 Fig. 2
 TBI 21-6334-03 Fig. 3
 TBI 21-6334-04 Fig. 4
 TBI 21-6334-05 Fig. 5





Krause
TBI 21-6335-16
16 cm/6 1/4"



Krause-Voss
TBI 21-6336-16
16 cm/6 1/4"



Lange-Wilde
TBI 21-6337-16
16 cm/6 1/4"



Package of 1 dozen each
 mm Ø
 TBI 21-6338-02 0.2
 TBI 21-6338-03 0.3



TBI 21-6338-03 0.3mm Ø
 TBI 21-6338-04 0.4mm Ø



TROELTSCH (WILDE)
TBI 21-6339-13 13.0cm

Ear Dressing Forceps



Cm	In	Troeltsch (Wilde)	Troeltsch
11.0	4 3/4"	TBI 21-6340-11	1 x 2 teeth
12.0	4 3/4"	TBI 21-6340-12	TBI 21-6343-11
14.0	5 1/2"	TBI 21-6340-14	TBI 21-6343-12
15.0	6"	TBI 21-6340-15	
16.0	6 1/4"		
18.0	7"		
20.0	8"		



Lucae
TBI 21-6344-14



Lucae
1 x 2 teeth
TBI 21-6345-14



Jansen
TBI 21-6346-16
TBI 21-6346-18
TBI 21-6346-20

TONSIL



Okonogto
 TBI 21-6347-16
 16 cm/6 1/4"



Littauer
 TBI 21-6348-12
 12 cm/4 3/4"



Hartmann
 TBI 21-6349-12
 12 cm/4 3/4"



Hartmann
 TBI 21-6350-14
 14 cm/5 1/2"



Standard Pattern

Tilley Aural Forceps
 TBI 21-6351-14 14cm/5 1/2"
 TBI 21-6351-16 16cm/6 1/4"
 TBI 21-6351-18 18cm/7"



Buck
 TBI 21-6352-09
 9 cm/3 1/2"



Quire
 TBI 21-6353-08
 8 cm/3 1/4"





Hartmann-Noyes
TBI 21-6354-09
8.5 cm/3 1/4"



1 : 2

Hartmann-Noyes
TBI 21-6355-09
8.5 cm/3 1/4"



Hartmann
TBI 21-6356-09 8.5 cm/3 1/4"
TBI 21-6356-14 14 cm/5 1/2"
TBI 21-6356-16 16 cm/6 1/4"



1 : 2

Hartmann
TBI 21-6357-09 8.5 cm/3 1/4"
TBI 21-6357-14 14.0 cm/5 1/2"



Hartmann
TBI 21-6358-20 8.5 cm/3 1/4" ○ 2.0 mm
TBI 21-6358-25 8.5 cm/3 1/4" ○ 2.5 mm
TBI 21-6358-30 8.5 cm/3 1/4" ○ 3.0 mm



Hartmann-Citelli
TBI 21-6359-02 ○ 2 mm 8.5 cm/3 1/4"
TBI 21-6359-03 ○ 3 mm 8.5 cm/3 1/4"



Strumpel
TBI 21-6360-09
8.5 cm/3 1/4"



Hartamm-Weingartner
TBI 21-6361-09
8.5 cm/3 1/4"



HARTMANN
TBI 21-6361-10 8.5cm



Hartamm
TBI 21-6362-09
8.5 cm/3 1/4"



Hartamm-Wullstein
TBI 21-6363-06 8.5 cm/3 1/4" 08 x 6 mm
TBI 21-6363-08 8.5 cm/3 1/4" 1.8 x 8 mm



HARTMANN
TBI 21-6363-09 8.5cm



Hartamm-Hoffmann
TBI 21-6364-01 ○ 1 mm 8.5 cm/3 1/4"
TBI 21-6364-02 ○ 2 mm 8.5 cm/3 1/4"





MINI McGEE ALLIGATOR



TBI 21-6365-01
 4.0 x 0.8mm
 straight, smooth



TBI 21-6365-02
 4.0 x 0.8mm
 straight, serrated



TBI 21-6365-03
 4.0 x 0.8mm
 curved up



TBI 21-6365-04
 4.0 x 0.8mm
 right



TBI 21-6365-05
 4.0 x 0.8mm
 left



TBI 21-6365-06
 3.5 x 0.6mm
 straight, smooth



TBI 21-6365-07
 3.5 x 0.6mm
 straight, serrated



TBI 21-6365-08
 4.0 x 0.6mm
 straight, smooth



TBI 21-6365-09
 4.0 x 0.6mm
 straight, serrated



TBI 21-6365-10
 3.0 x 0.6mm
 curved up, serrated



TBI 21-6365-11
 3.0 x 0.6mm
 right, serrated



TBI 21-6365-12
 3.0 x 0.6mm
 left, serrated



0.6mm



TBI 21-6366-01
 3.5 x 0.5mm
 straight



TBI 21-6366-02
 3.5 x 0.5mm
 curved up



TBI 21-6366-03
 3.5 x 0.5mm
 right



TBI 21-6366-04
 3.5 x 0.5mm
 left



1.0mm



TBI 21-6367-01
 4.0 x 0.9mm
 straight



TBI 21-6367-02
 4.0 x 0.9mm
 curved up



TBI 21-6367-03
 4.0 x 0.9mm
 right



TBI 21-6367-04
 4.0 x 0.9mm
 left





WULLSTEIN



TBI 21-6378-01
4.0 x 0.8mm
straight



TBI 21-6378-02
4.0 x 0.8mm
curved up



TBI 21-6378-03
4.0 x 0.8mm
right



TBI 21-6378-04
4.0 x 0.8mm
left



BELLUCCI



TBI 21-6379-01
4.0 x 1.5mm
straight



TBI 21-6379-02
4.0 x 1.5mm
curved up



TBI 21-6379-03
4.0 x 1.5mm
right



TBI 21-6379-04
4.0 x 1.5mm
left



Henckel
crocodile, scoop blades
TBI 21-6380-02



Cawthorne
micro crocodile scissor, 5 mm blade
TBI 21-6381-01 Straight
TBI 21-6381-02 Curved
TBI 21-6381-03 Angled

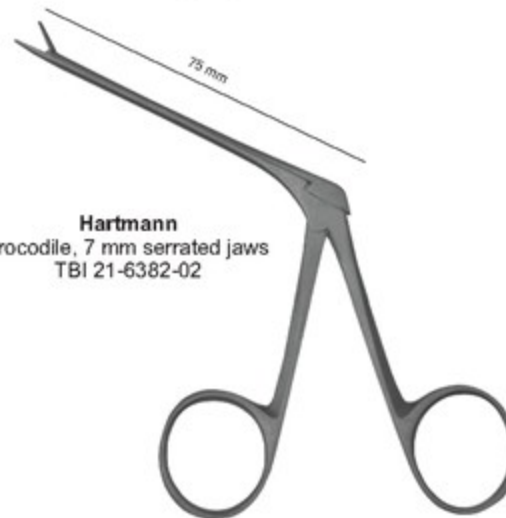

Hartmann
crocodile, 7 mm serrated jaws
TBI 21-6382-02

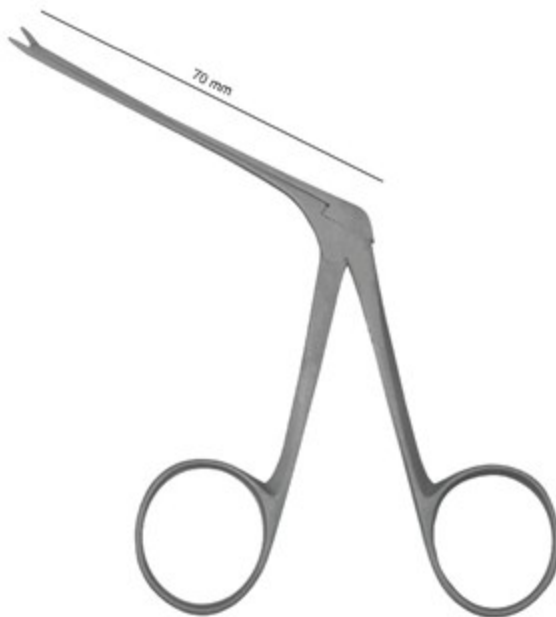

Hartmann
micro crocodile, 3 mm serrated jaws
TBI 21-6383-02



Hough
medium micro crocodile
5 mm serrated jaws
TBI 21-6384-01 Straight
TBI 21-6384-02 Angled





McGEE
 TBI 21-6385-01 0.8 X 3.5mm
 TBI 21-6385-02 0.8 X 6.0mm

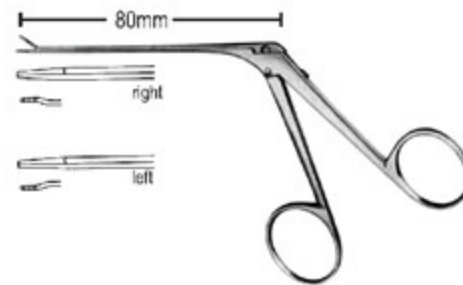

JUERS
 TBI 21-6386-01 right
 TBI 21-6386-02 left



GREVEN
 TBI 21-6387-01



SCHUKNECHT
 TBI 21-6388-01



FULLER
 TBI 21-6389-01

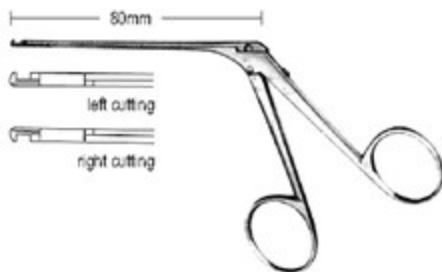

HOUSE-DIETER
 TBI 21-6390-01 left cutting
 TBI 21-6390-02 right cutting



HOUSE-DIETER
 TBI 21-6391-01 down cutting
 TBI 21-6391-02 up cutting



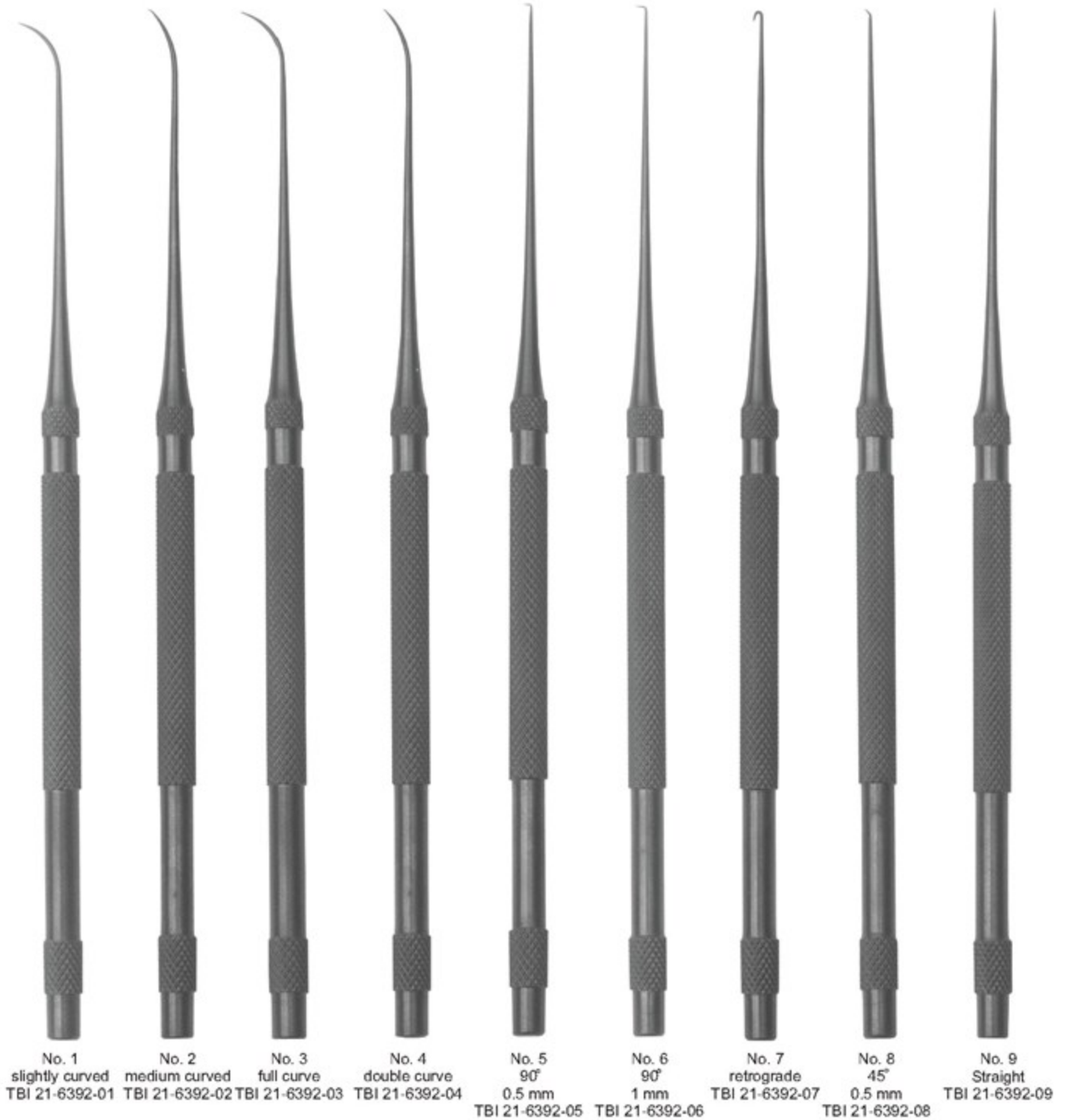

Cawthorne Stape Hook (Black Finish)
 16.5cm / 6 1/2"
 TBI 21-6392-10 (set of 9)

Messer



Schuknecht
 TBI 21-6393-01

Schuknecht
 TBI 21-6394-02

Schuknecht
 TBI 21-6395-01

Knives



Wullstein
 TBI 21-6396-01



Tabb
 TBI 21-6397-01



Plester
 TBI 21-6398-01



Plester
 TBI 21-6399-02



TBI 21-6400-03



Rosen



TBI 21-6401-10
 1.0 mm



TBI 21-6402-14
 1.4 mm



TBI 21-6403-16
 1.6 mm



TBI 21-6404-20
 2.0 mm



TBI 21-6405-26
 2.6 mm



TBI 21-6406-28
 2.8 mm



TBI 21-6407-30
 3.0 mm





Needles And Hooks

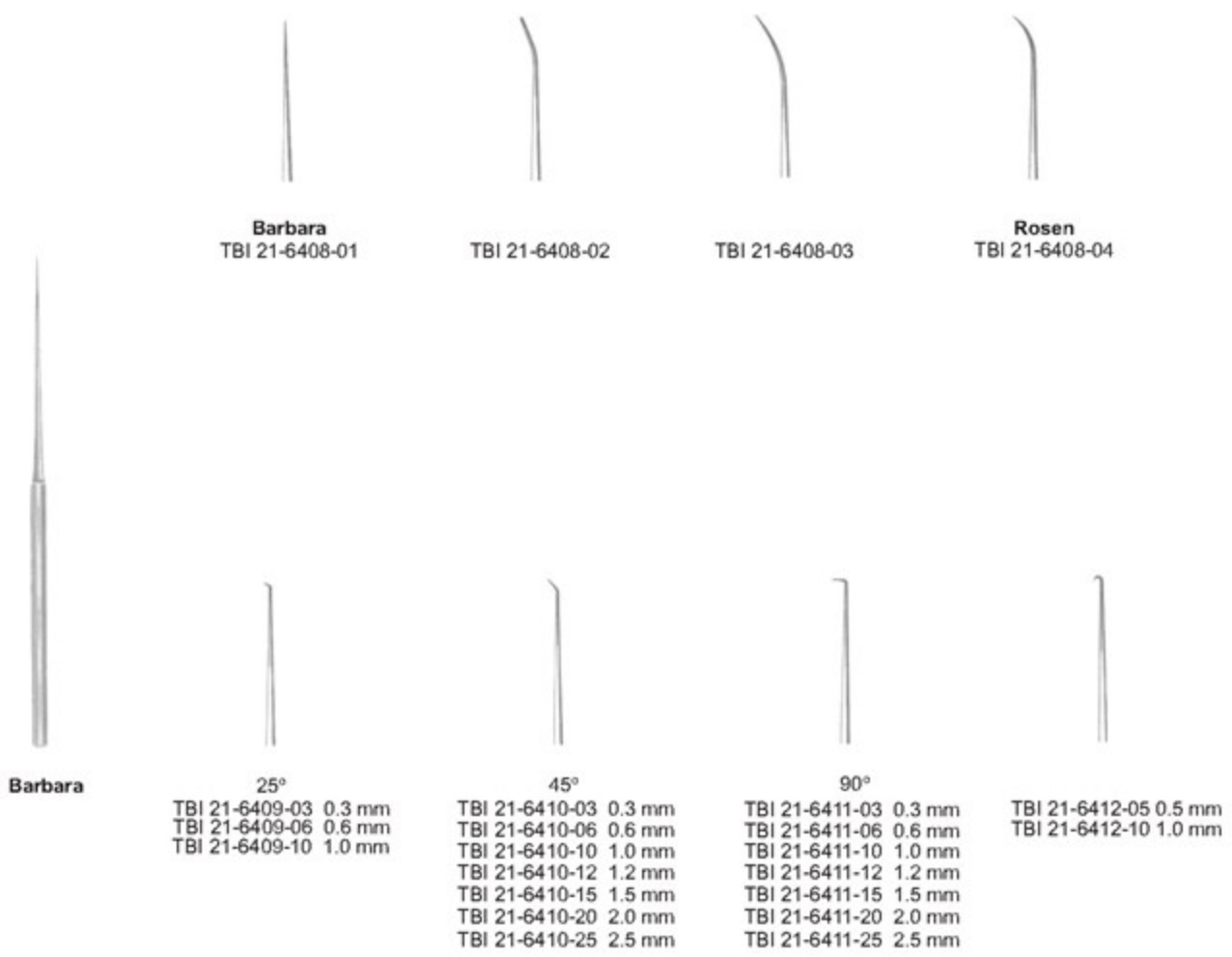

Needles And Hooks



90°		90°		McGee		McGee	
TBI 21-6413-03	0.3 mm	TBI 21-6414-03	0.3 mm	TBI 21-6415-05	0.5 mm	TBI 21-6416-05	0.5 mm
TBI 21-6413-06	0.6 mm	TBI 21-6414-06	0.6 mm	TBI 21-6415-10	1.0 mm	TBI 21-6416-10	1.0 mm
TBI 21-6413-10	1.0 mm	TBI 21-6414-10	1.0 mm				



	25°		25°		45°		45°	
0.3 mm	TBI 21-6417-03	TBI 21-6418-03	TBI 21-6419-03	TBI 21-6420-03				
0.6 mm	TBI 21-6417-06	TBI 21-6418-06	TBI 21-6419-06	TBI 21-6420-06				
1.0 mm	TBI 21-6417-10	TBI 21-6418-10	TBI 21-6419-10	TBI 21-6420-10				
	Left	Right	Left	Right				

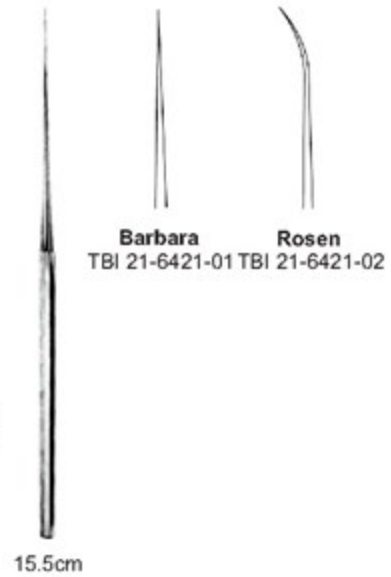

Dissectors, Measuring Road, Elevators, Curettes and Mobilizer



Fisch



TBI 21-6422-01



TBI 21-6422-02



TBI 21-6422-03



TBI 21-6422-04



Rosen

TBI 21-6423-15 1.5 mm
 TBI 21-6423-25 2.5 mm



Rosen



TBI 21-6424-01



TBI 21-6424-02



TBI 21-6424-03



TBI 21-6424-04



TBI 21-6424-05



TBI 21-6424-06



House



TBI 21-6425-01
3.5 mm



TBI 21-6425-02
4.0 mm



TBI 21-6425-03
4.5 mm



TBI 21-6425-04
5.0 mm



Buckingham



TBI 21-6426-01



TBI 21-6426-02



TBI 21-6426-03



St. Bart Blunt Hook
 TBI 21-6427-18
 18 cm / 7"



House
 TBI 21-6428-10 1.0/1.2 mm
 TBI 21-6428-15 1.5/1.8 mm



House
 TBI 21-6429-10 1.0/1.2 mm
 TBI 21-6429-15 1.5/1.8 mm



Shea
 TBI 21-6430-15 1.5 mm



Negus Aspiration
 TBI 21-6431-18
 21 cm / 8 1/4"



Jobson Horne Probe
 one side serrated
 one side ring
 TBI 21-6432-17
 17.5 cm / 7"



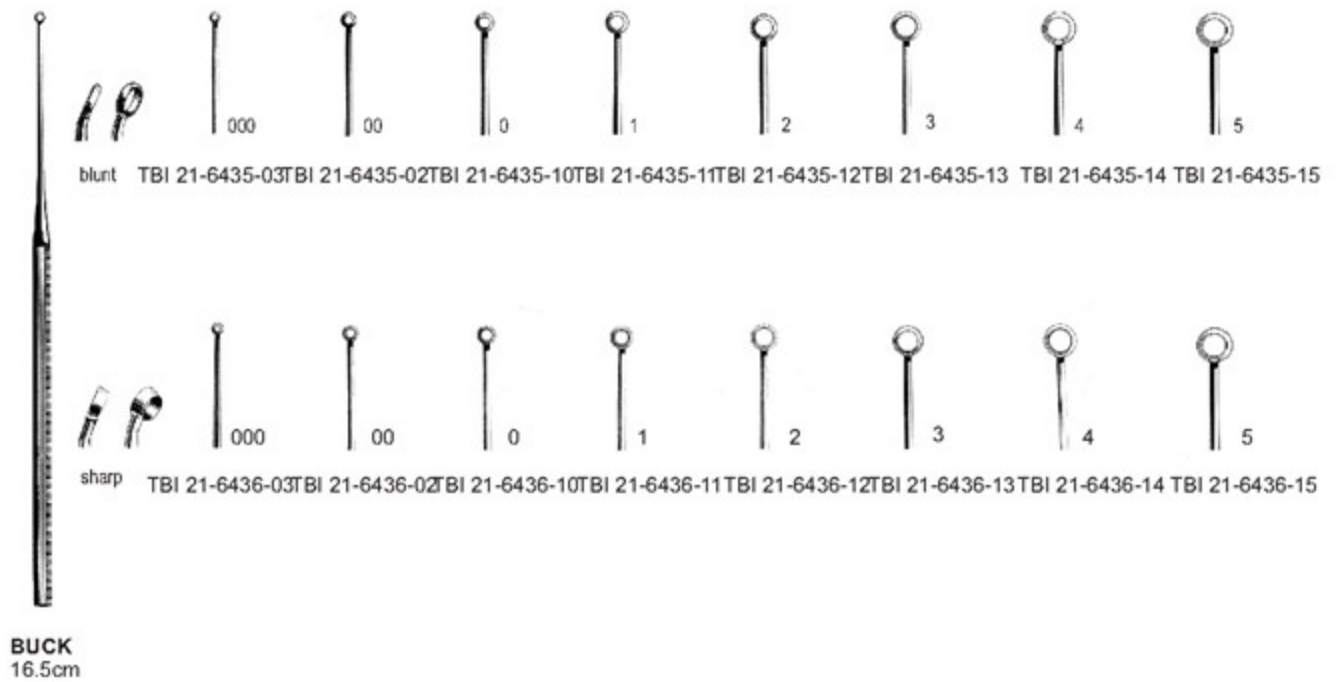
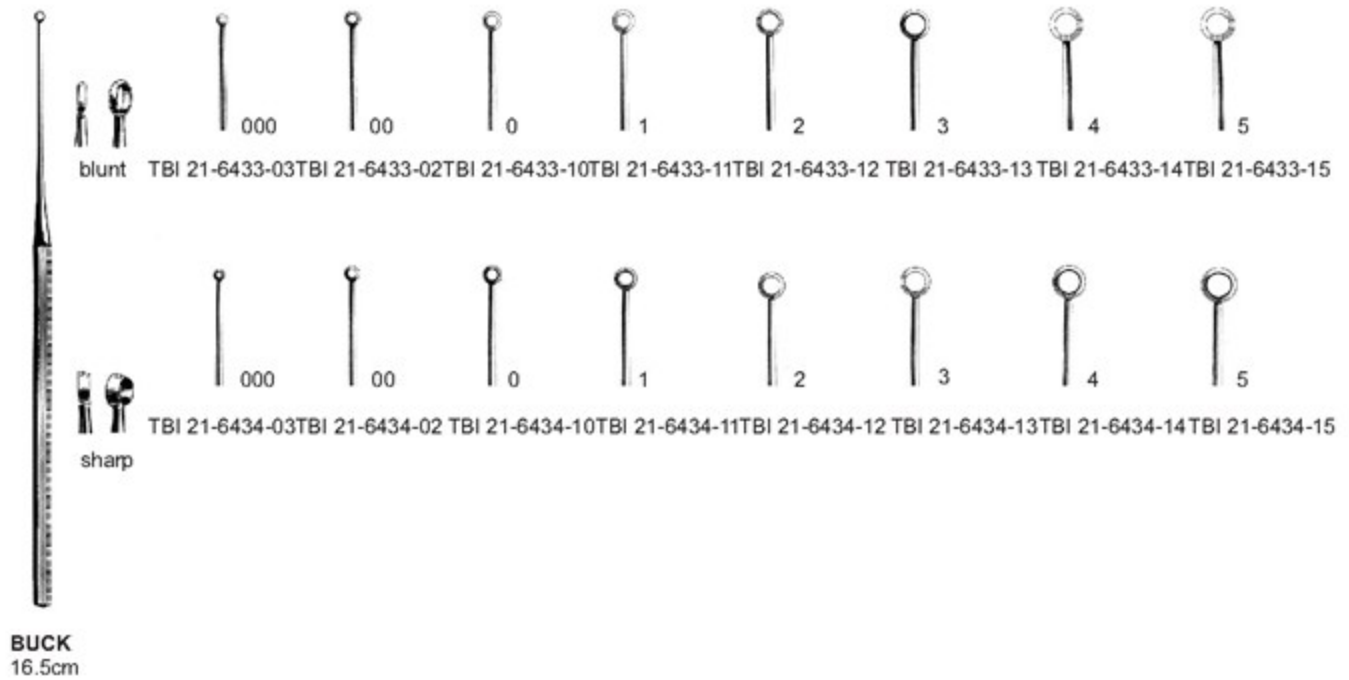



Width of Bite
Citelli
 TBI 21-6437-20 2.0 mm
 TBI 21-6437-30 3.0 mm



Width of Bite
Citelli-Beyer
 TBI 21-6438-15 1.5 mm
 TBI 21-6438-20 2.0 mm



Width of Bite
 4.0 mm
 6.0 mm
Brunings
 TBI 21-6439-40
 TBI 21-6439-60

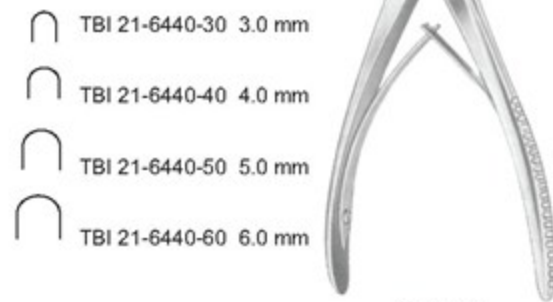

TBI 21-6440-30 3.0 mm
 TBI 21-6440-40 4.0 mm
 TBI 21-6440-50 5.0 mm
 TBI 21-6440-60 6.0 mm
Kerrison
 20 cm/8"



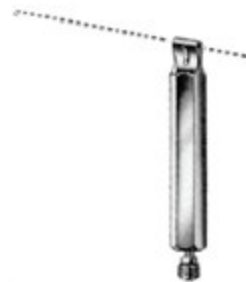

TBI 21-6441-10



TBI 21-6442-15



TBI 21-6443-01
7.0cm



TBI 21-6443-02
7.0cm



TBI 21-6443-03
7.0cm



TBI 21-6443-04
7.0cm



TBI 21-6443-05
7.0cm



TBI 21-6443-06
7.0cm



TBI 21-6443-07
7.0cm

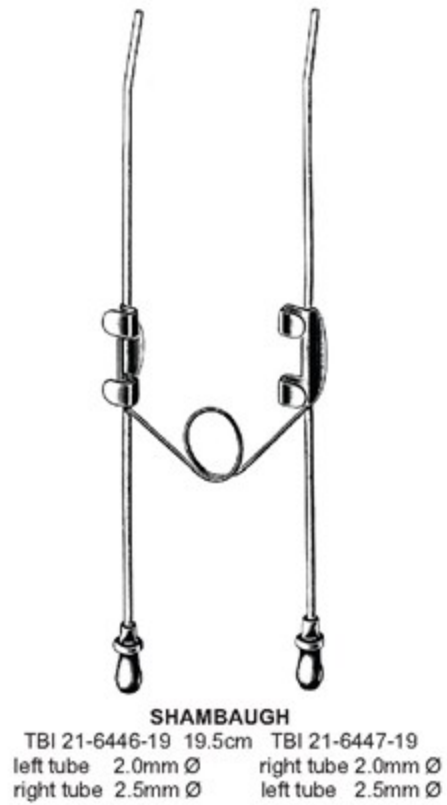
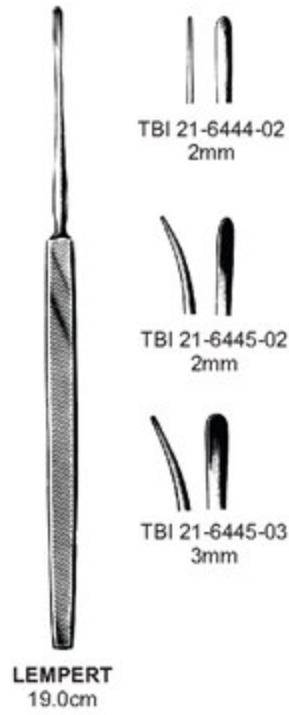



LANGENBECK
TBI 21-6450-13
13.0cm



SHAPLEIGH
13.0cm



TBI 21-6451-01



TBI 21-6451-02



TBI 21-6451-03



TBI 21-6451-04



COXETER
TBI 21-6452-15
15.0cm
blunt



TBI 21-6453-17 17.0cm blunt
 TBI 21-6453-18 17.0cm sharp



JANSSEN
TBI 21-6454-15
15.0cm
sharp



BARTH
TBI 21-6455-18
18.0cm
sharp

TONSIL



GROSS
TBI 21-6456-12
12.0cm, blunt



GROSS
TBI 21-6457-12
12.0cm
blunt - sharp



GROSS
TBI 21-6458-12
12.0cm
blunt



GROSS
TBI 21-6459-12
12.0cm
blunt



GROSS
TBI 21-6460-12
12.0cm
blunt - sharp



TBI 21-6461-01



TBI 21-6461-02

16.0cm



TBI 21-6462-01



TBI 21-6462-02



TBI 21-6462-03

BILLEAU
16.5cm



MOLDENHAUER
TBI 21-6463-16
16.5cm



ZAUFAL
TBI 21-6464-16
16.0cm



HARTMANN
TBI 21-6465-16
16.0cm



BARKER
TBI 21-6466-17
17.0cm



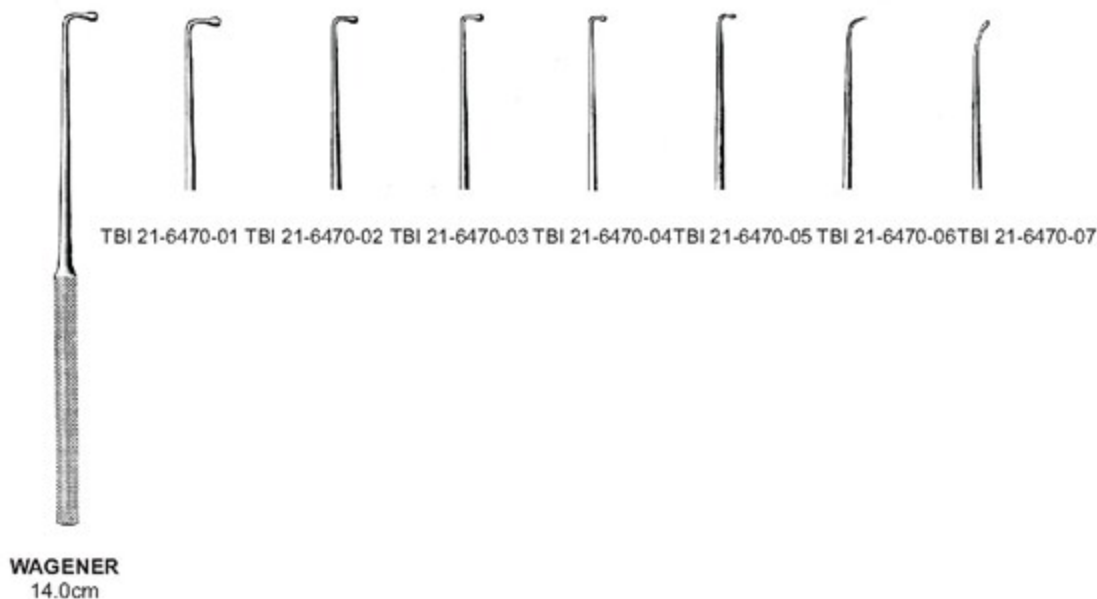
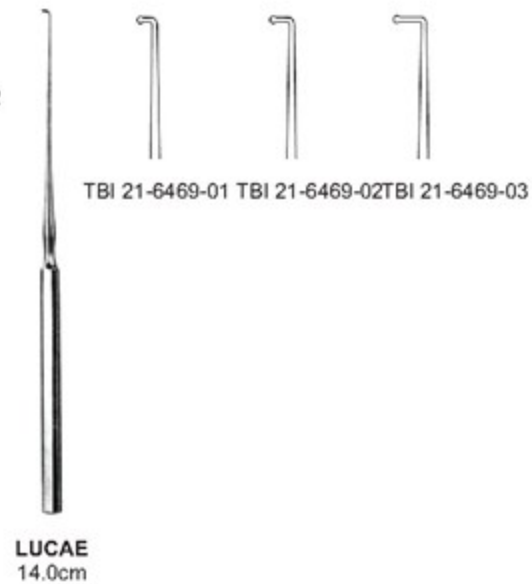
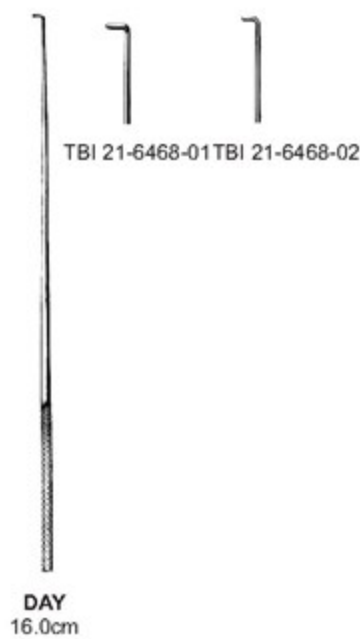

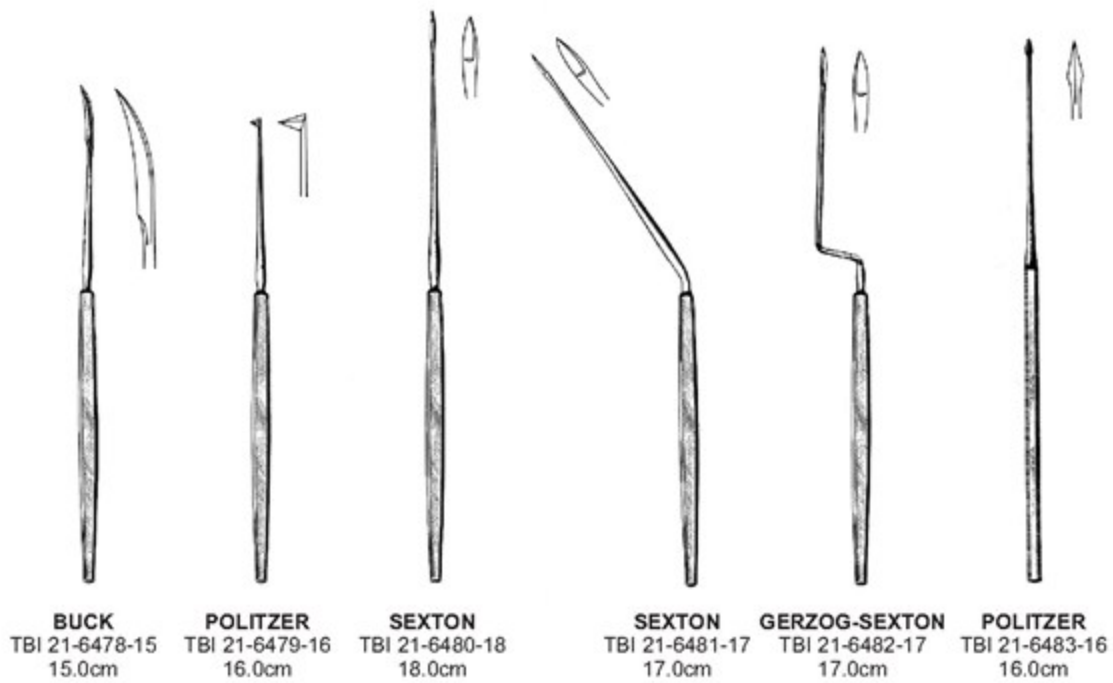
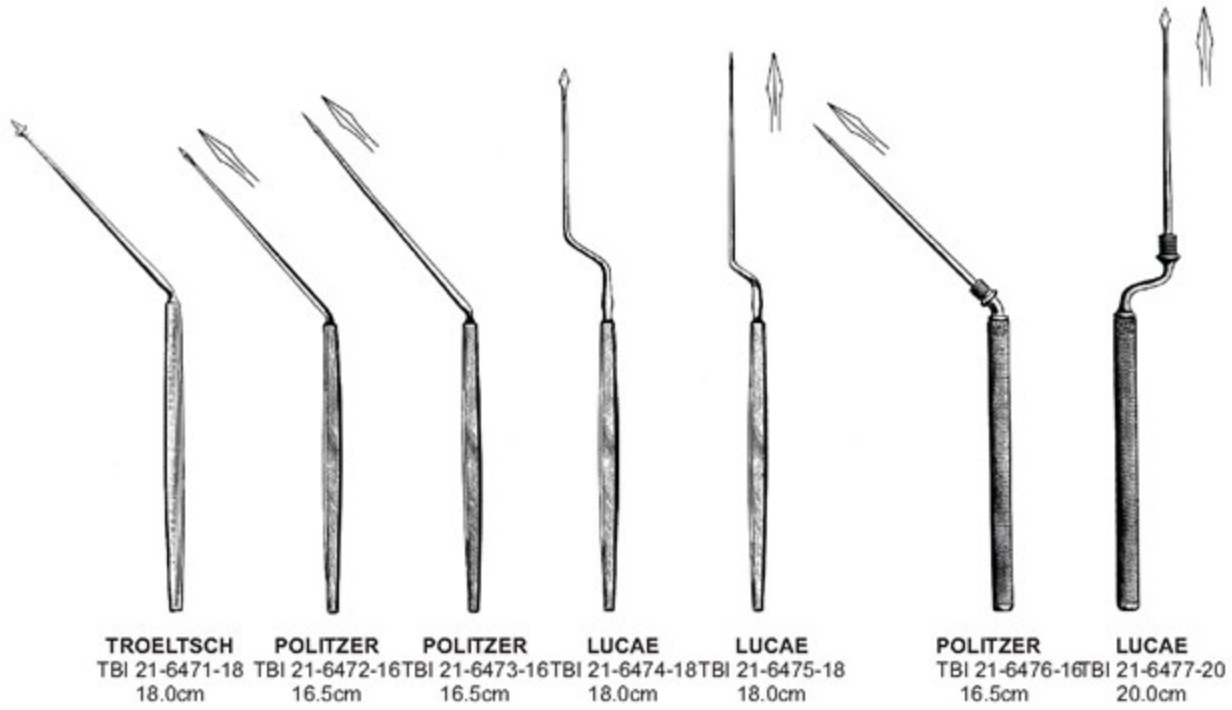



HARTMANN-OSTMANN
 TBI 21-6484.00
 set of 8 tuning forks

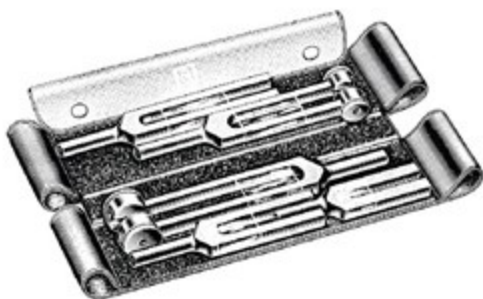

TBI 21-6485-00
 set of 5 alloy tuning forks



HARTMANN
 TBI 21-6486-00 TBI 21-6487-00
 set of 5 tuning forks set of 6 tuning forks

EN Rhinology

DE Rhinologie

ES Rinología

Page 541 to 574



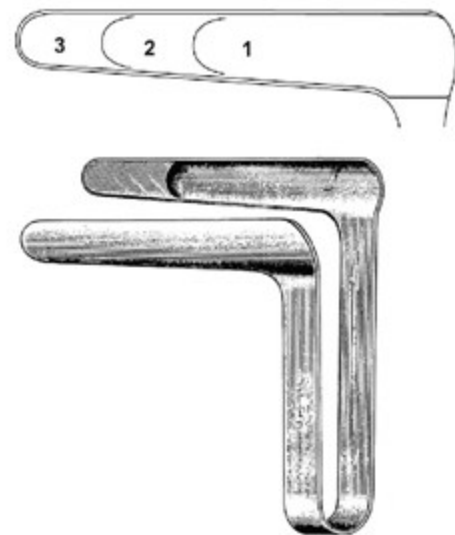
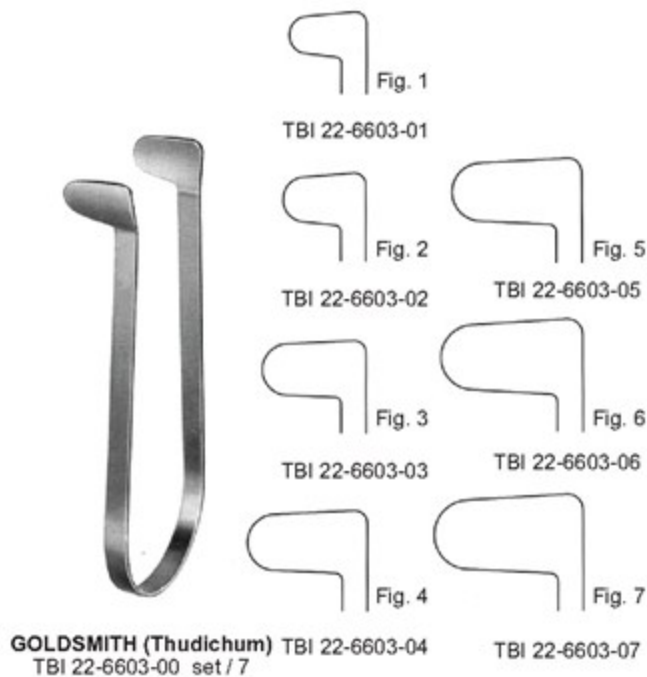
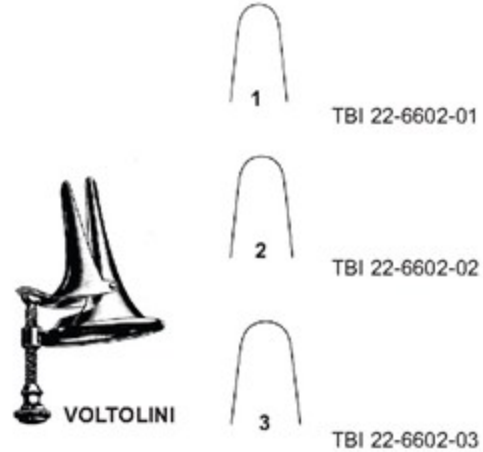



HARTMANN-HALLE
 15.0cm
 TBI 22-6605-01 Fig. 1
 TBI 22-6605-02 Fig. 2
 TBI 22-6605-03 Fig. 3

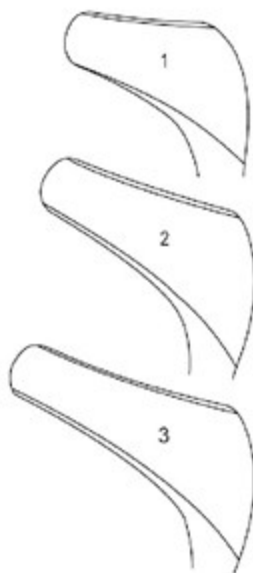

SCHWARZ
 TBI 22-6606-14
 14.0cm



VIENNA
 14.5cm
 TBI 22-6607-01 (infant)
 TBI 22-6607-02 (child)
 TBI 22-6607-03 (adult)
 TBI 22-6607-04 (sheet metal)



MOD WIEN
 TBI 22-6608-14
 14.5cm





TBI 22-6609-13
13.0cm



TBI 22-6610-13
13.0cm



TIECK-HALLE
13.5cm
TBI 22-6611-01
TBI 22-6611-02



TIECK-HALLE
TBI 22-6612-13
13.5cm



KILLIAN
13.0cm
TBI 22-6613-35
TBI 22-6613-50
TBI 22-6613-75
TBI 22-6613-90

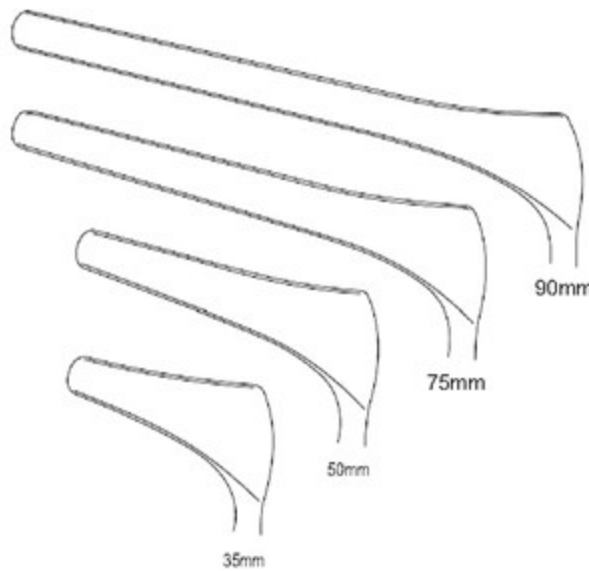

KILLIAN (with side screw)
13.0cm
TBI 22-6614-35
TBI 22-6614-50
TBI 22-6614-75
TBI 22-6614-90



COTTLE
 15.0cm
 TBI 22-6615-35
 TBI 22-6615-50
 TBI 22-6615-75
 TBI 22-6615-90

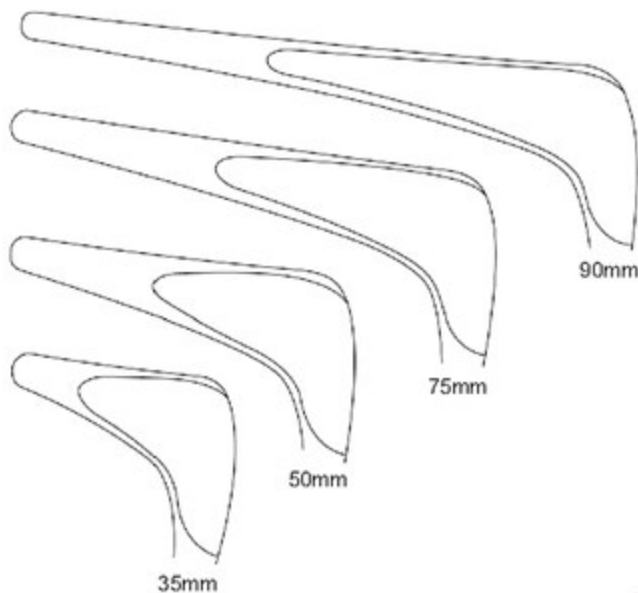

COTTLE (with side screw)
 15.0cm
 TBI 22-6616-35
 TBI 22-6616-50
 TBI 22-6616-75
 TBI 22-6616-90



COTTLE
 (dull black chromium plated)
 14.0cm

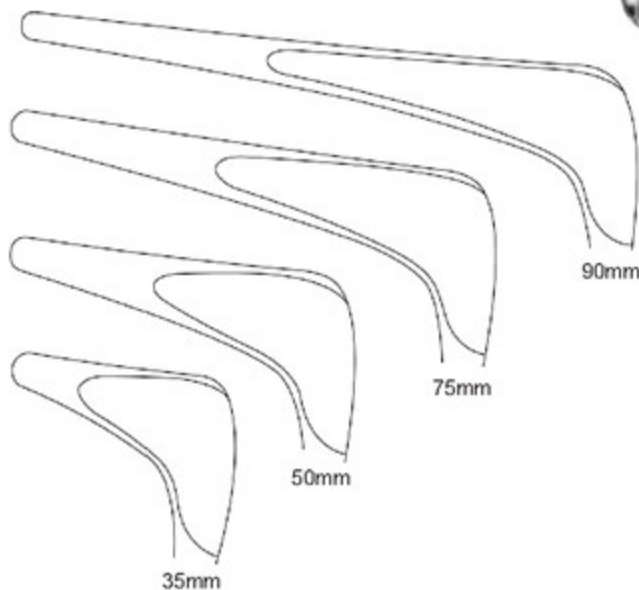

TBI 22-6617-35
 TBI 22-6617-50
 TBI 22-6617-75
 TBI 22-6617-90



YANKAUER
 TBI 22-6618-19
 19.0cm





10m

TBI 22-6619-03 0.3mm Ø
TBI 22-6619-04 0.4mm Ø



TBI 22-6620-02 0.2mm Ø
TBI 22-6620-03 0.3mm Ø



KRAUSE
TBI 22-6621-26
26.0cm

KRAUSE-VOSS
TBI 22-6622-26
26.0cm

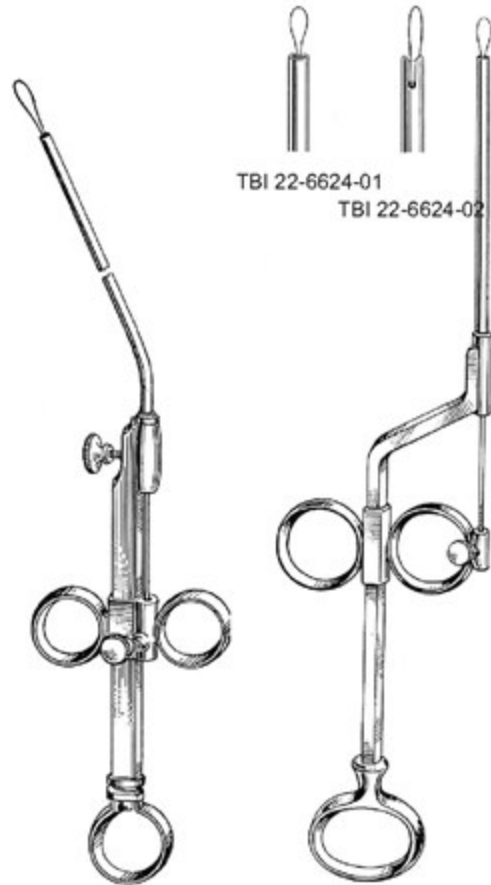

TBI 22-6624-01
TBI 22-6624-02

KRAUSE
TBI 22-6623-00

GLEGG

Nasal Polypus and Septum Compression Forceps
 Polypenzangen, Septumzange
 Pinzas para polipos, pinzas para el tabique nasal

EN
 DE
 ES

RHINOLOGY



KILLIAN
 TBI 22-6625-17
 17.0cm



LITTAUER
 TBI 22-6626-18
 18.0cm



HARTMANN
 TBI 22-6627-20
 20.0cm



QUIRE
 TBI 22-6628-12
 12.0cm



GRAIG
 TBI 22-6629-18
 18.0cm



TBI 22-6630-01 TBI 22-6630-02

18.0cm





KNIGHT
TBI 22-6631-18
18.0cm



HEYMANN
18.0cm

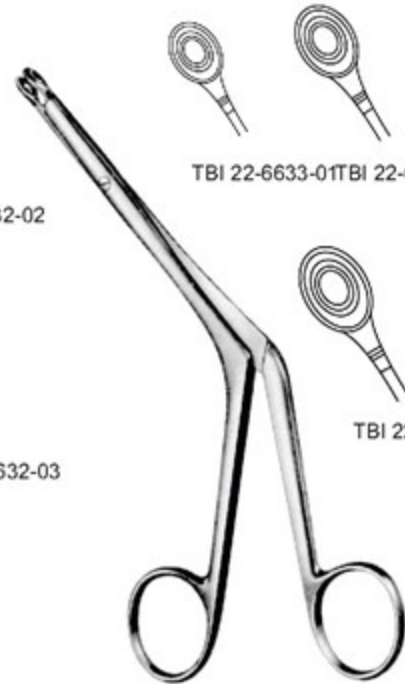

BRUENINGS
19.0cm



LUC
20.0cm

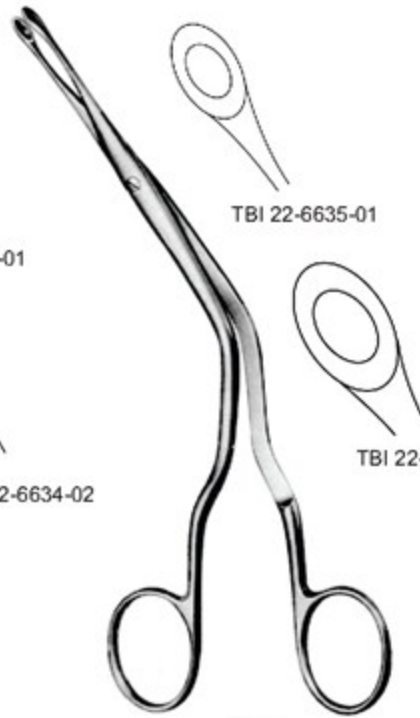

LUC
20.0cm

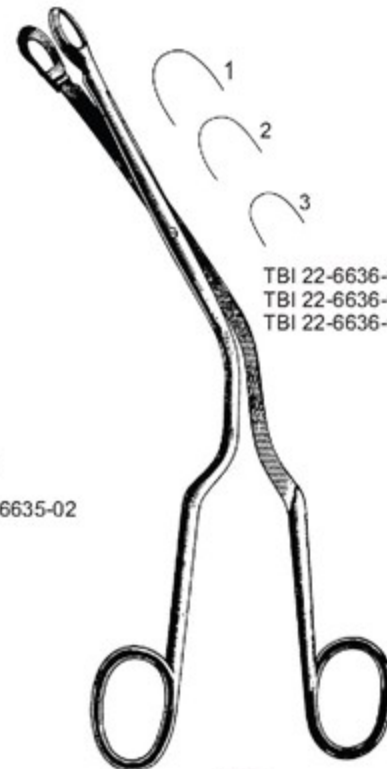

LUC
20.0cm

TBI 22-6632-01 TBI 22-6632-02

TBI 22-6632-03

TBI 22-6633-01 TBI 22-6633-02

TBI 22-6633-03 TBI 22-6633-04

TBI 22-6634-01

TBI 22-6634-02

TBI 22-6635-01

TBI 22-6635-02

TBI 22-6636-01 Fig. 1
 TBI 22-6636-02 Fig. 2
 TBI 22-6636-03 Fig. 3

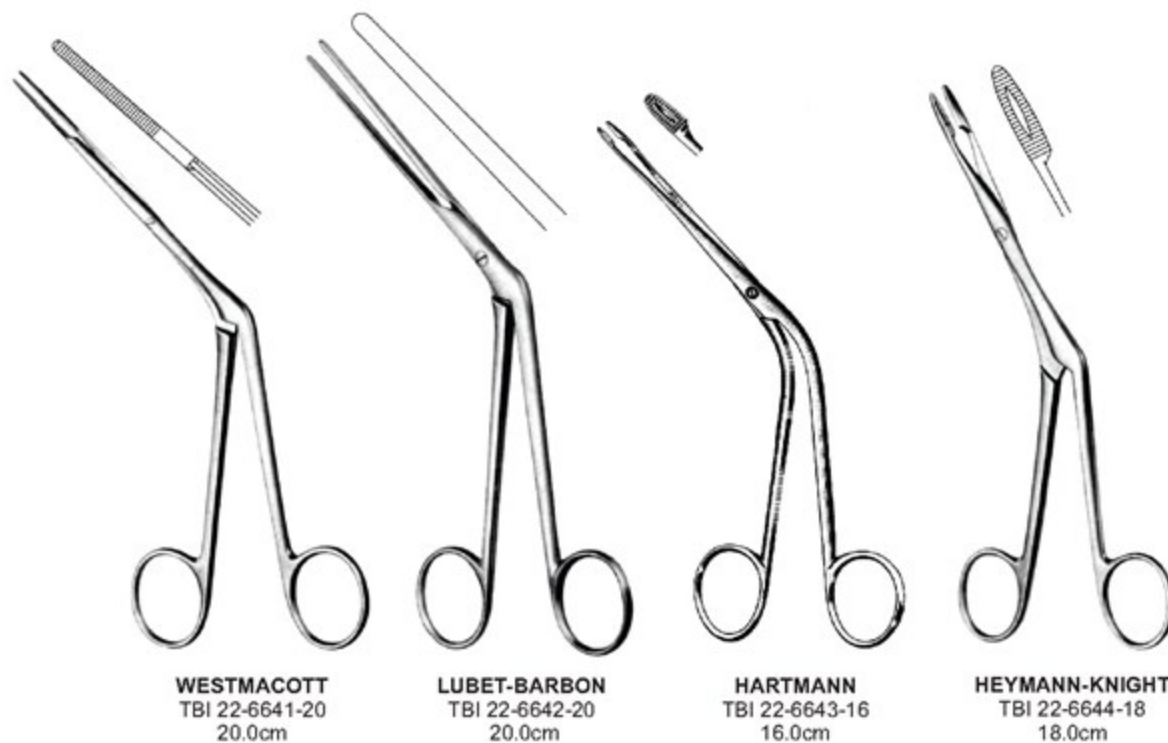
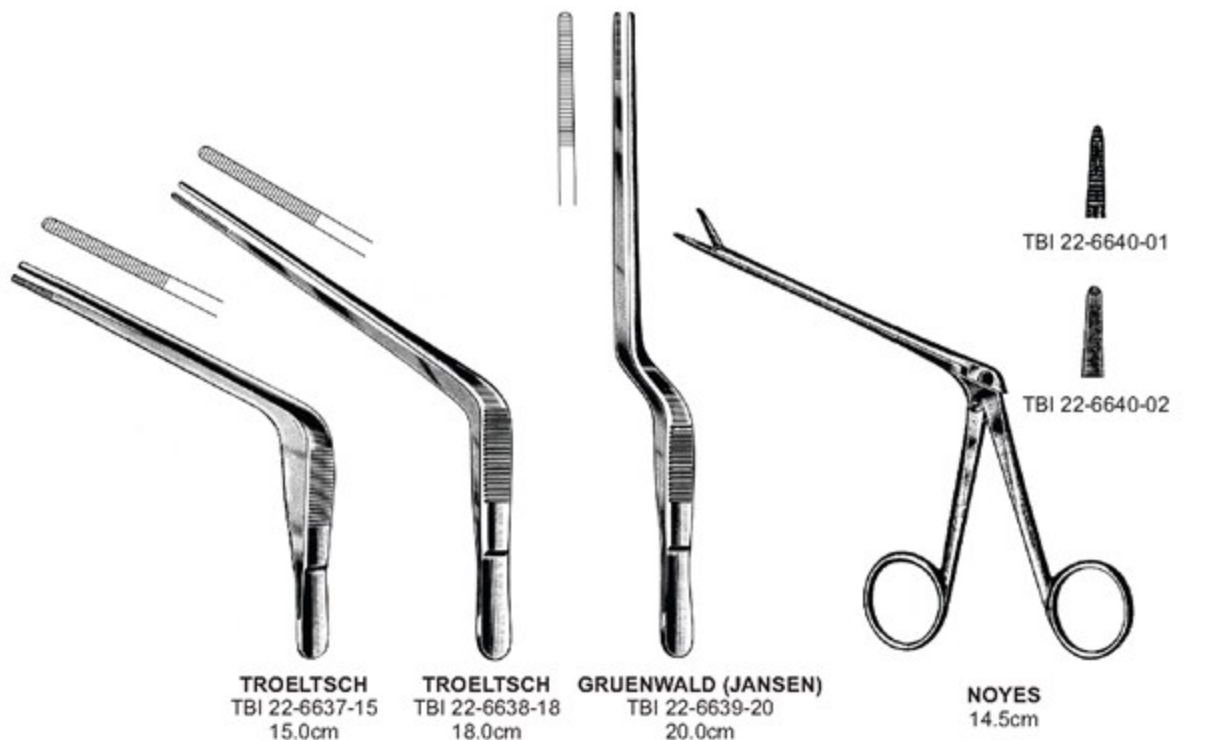



HENCKEL
 TBI 22-6645-20
 20.0cm



JATHO
 TBI 22-6646-15



WEIL
 TBI 22-6647-12

TBI 22-6648-12

WATSON-WILLIAMS
 TBI 22-6648-19
 19.0cm

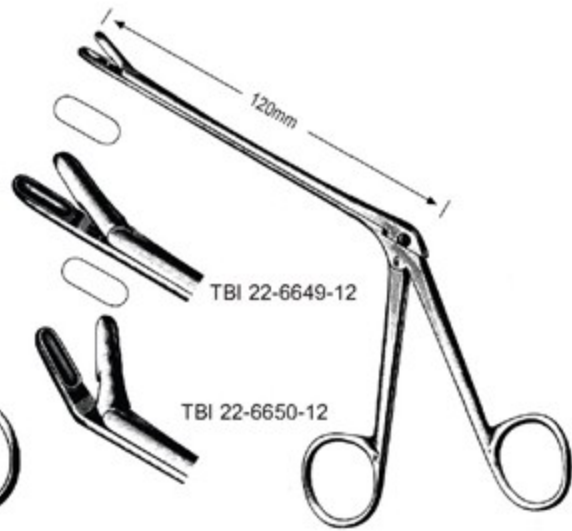

TBI 22-6649-12

TBI 22-6650-12

TAKAHASHI
 19.0cm



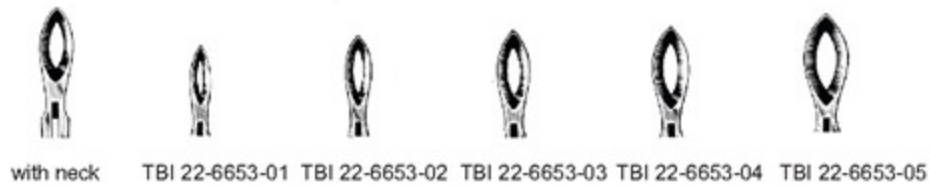
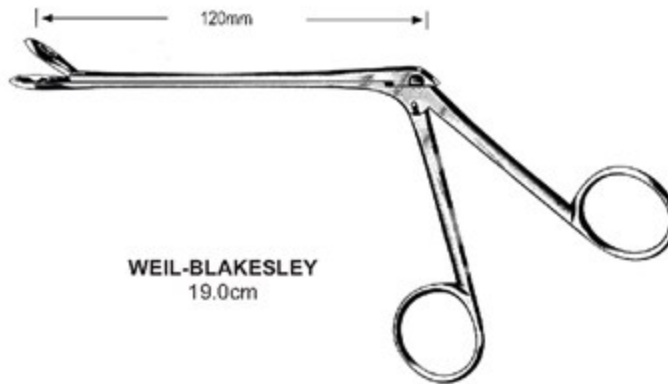
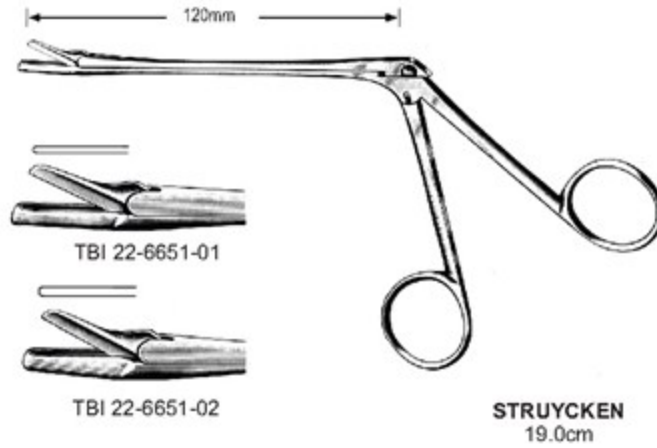

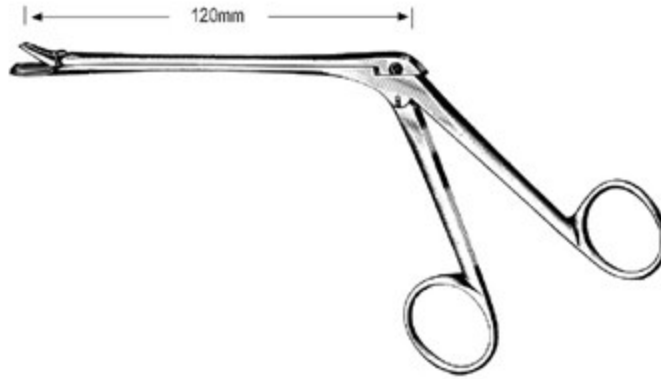

HAJEK
19.0cm

TBI 22-6654-12



SCHMEDEN
19.0cm

TBI 22-6655-12



HARTMANN
19.0cm

TBI 22-6656-01 5mm
TBI 22-6656-02 7mm
TBI 22-6656-03 9mm
TBI 22-6656-04 11mm



120mm

TBI 22-6657-01
2.2mm

TBI 22-6657-03
3mm

TBI 22-6657-02
2.6mm

TBI 22-6657-04
3.4mm



120mm

MYLES
19.0 cm

TBI 22-6658-01 TBI 22-6658-02

TBI 22-6658-03

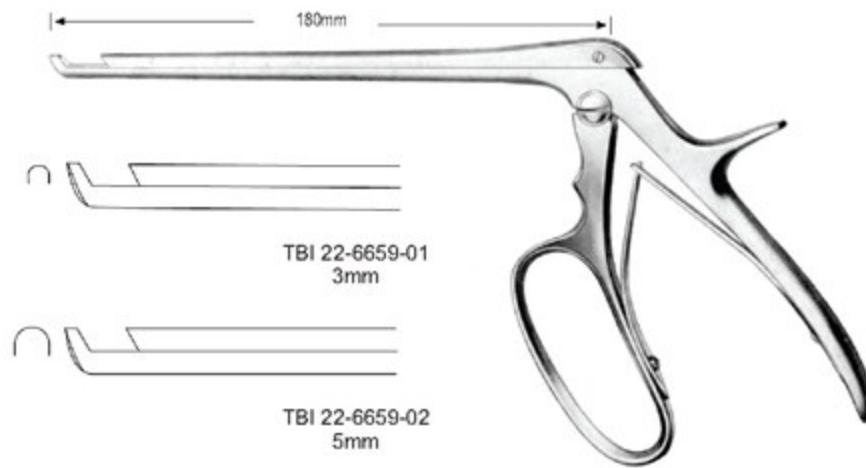

FERRIS-SMITH-KERRISON
 (CLOWARD HARPER)

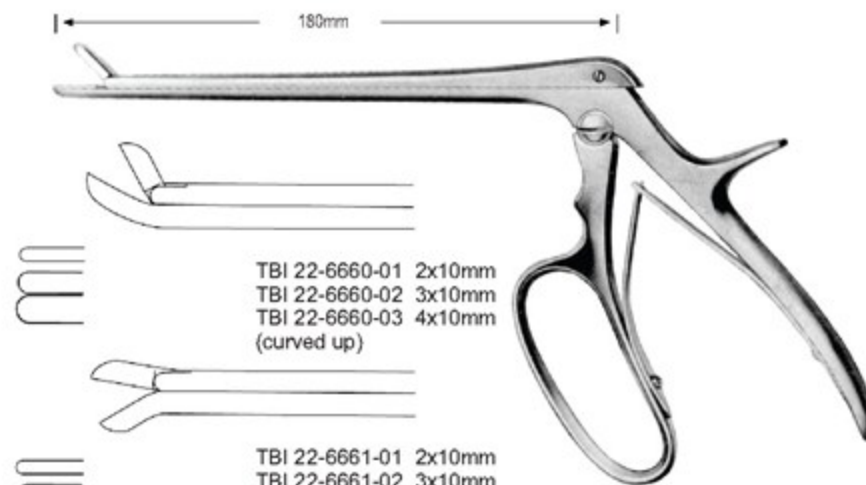

FERRIS-SMITH-CUSHING

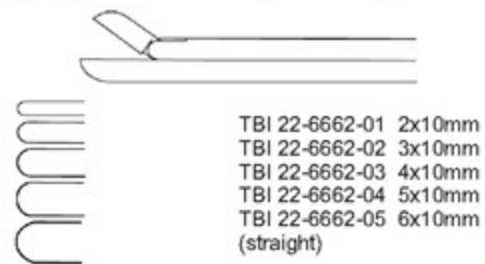

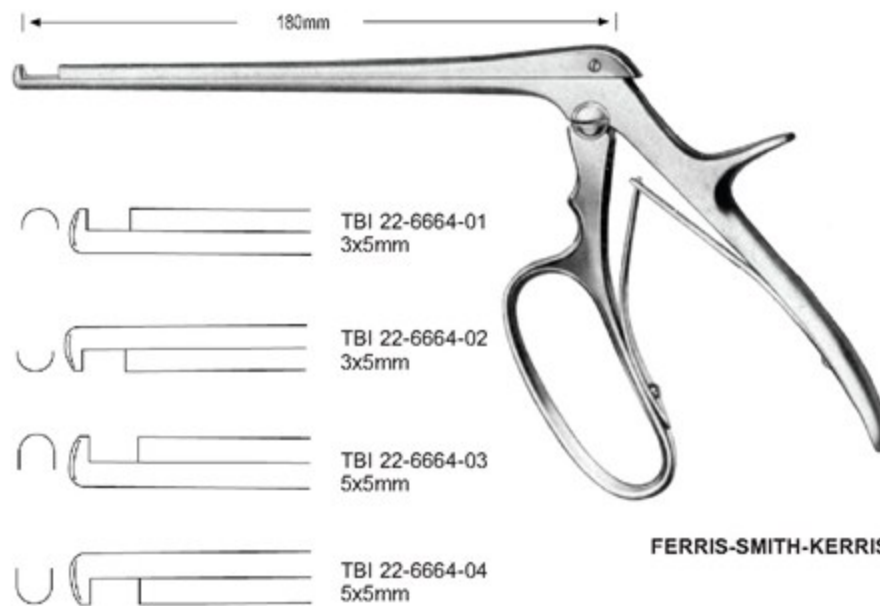
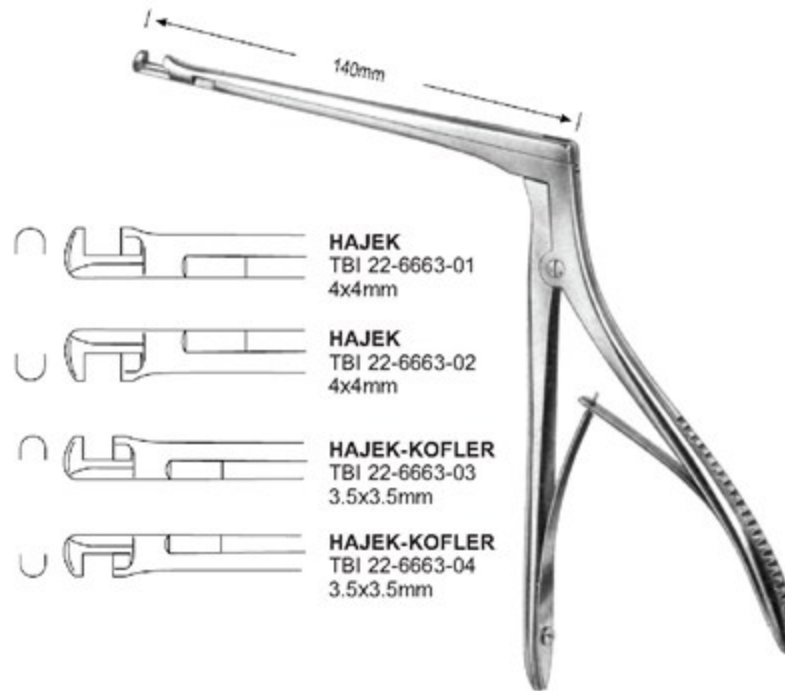





JANSEN-STRUYCKEN
TBI 22-6670-19
19.0cm



MIDDLETON-JANSEN
TBI 22-6671-19
19.0cm



MIDDLETON-JANSEN
TBI 22-6672-19
19.0cm



CAPLAN
TBI 22-6673-20
20.0cm



KILLIAN
TBI 22-6674-21
21.0cm



RUBIN
TBI 22-6675-21
21.0cm

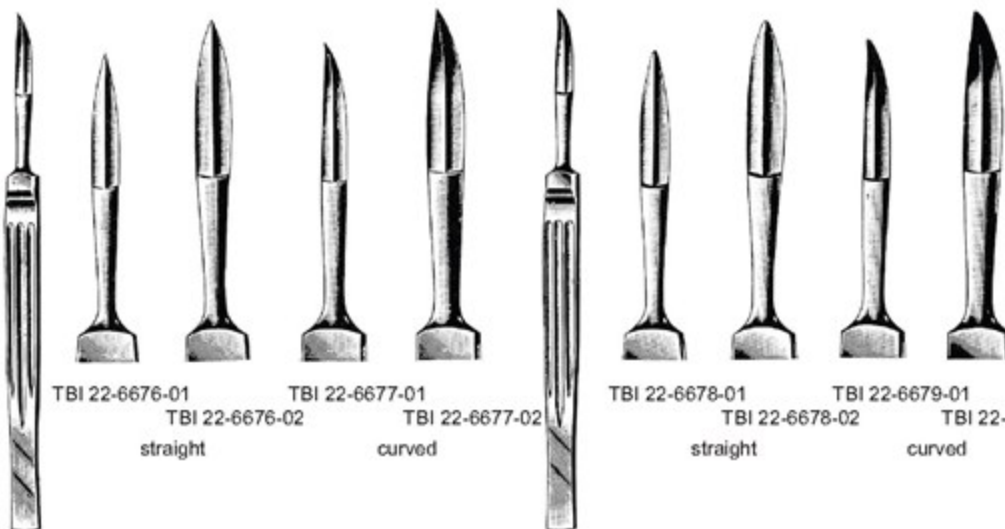

TBI 22-6676-01
 TBI 22-6676-02
 straight

TBI 22-6677-01
 TBI 22-6677-02
 curved

TBI 22-6678-01
 TBI 22-6678-02
 straight

TBI 22-6679-01
 TBI 22-6679-02
 curved

JOSEPH (sharp)
15.0cm

JOSEPH (blunt)
15.0cm

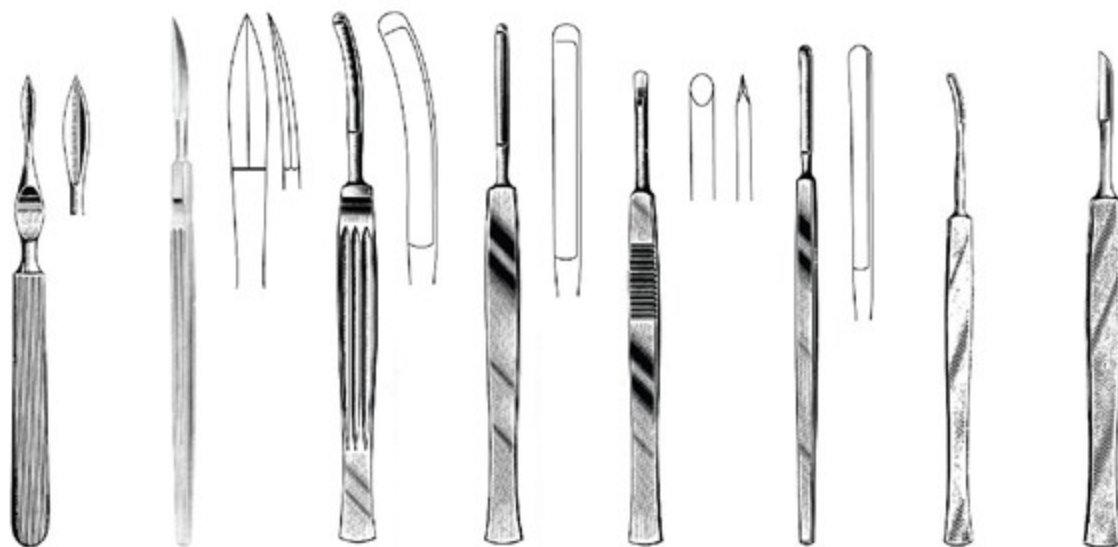

BALLENGER
TBI 22-6680-00

FOMON
TBI 22-6681-16
16.0cm

CONVERSE
TBI 22-6682-16
16.0cm

JOSEPH
TBI 22-6683-15
15.0cm

COTTLE
TBI 22-6684-15
15.0cm

COTTLE
TBI 22-6685-15
15.0cm

HEYMANN
TBI 22-6686-00

KRIEG
TBI 22-6687-00



- EN — Septum Knife, Mucous Knives, Swivel Knives
- DE — Septummesser, Mukosamesser, Schwingmesser
- ES — Cuchillo para el tabique nasal, la mucosa



BALLENGER
20.0cm

TBI 22-6688-03 TBI 22-6688-04 TBI 22-6688-05
3mm 4mm 5mm

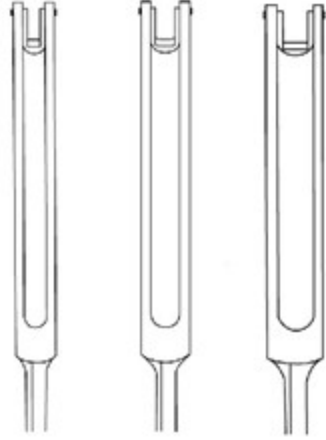

BALLENGER
20.0cm

TBI 22-6689-03 TBI 22-6689-04 TBI 22-6689-05
3mm 4mm 5mm

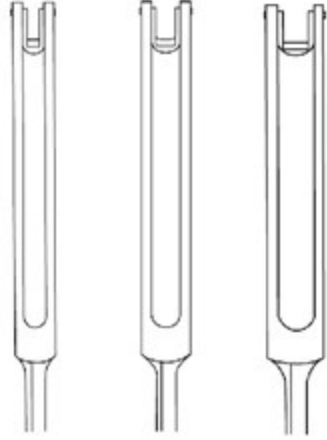

BRUENINGS
TBI 22-6690-16
16.5cm



FREER
TBI 22-6691-00



FREER
TBI 22-6692-15
15.0cm



FREER
TBI 22-6693-19
19.0cm



FREER
TBI 22-6694-19
19.0cm



FREER
TBI 22-6695-19
19.0cm



FREER
TBI 22-6696-19
19.0cm

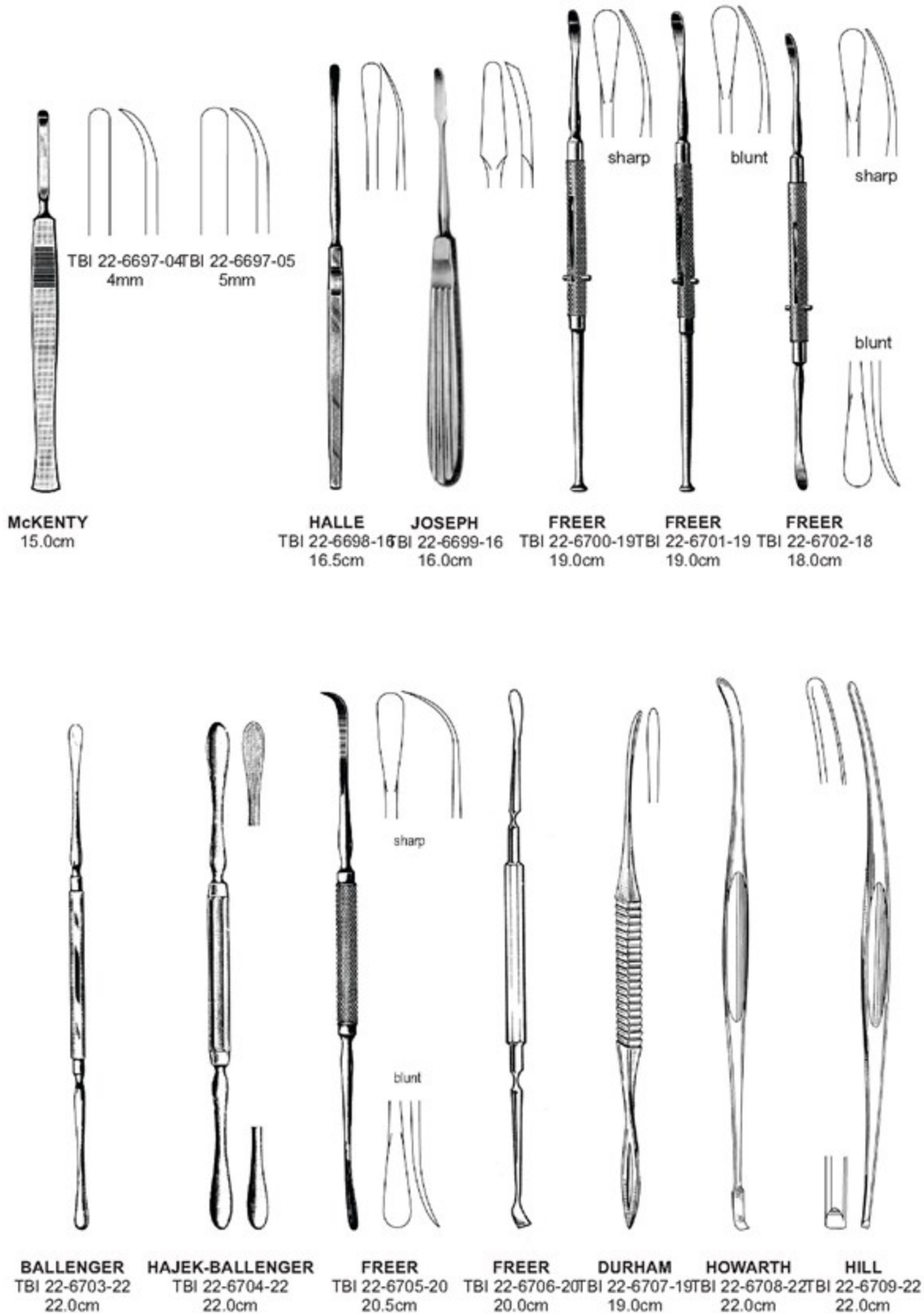

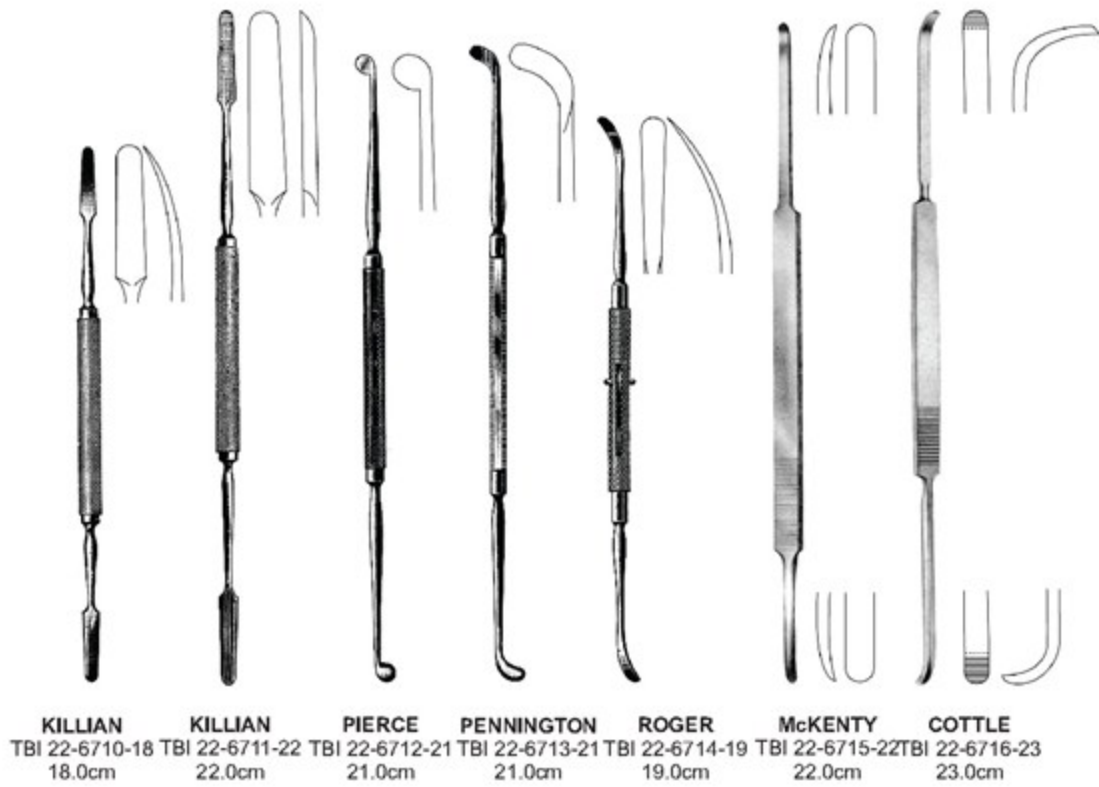

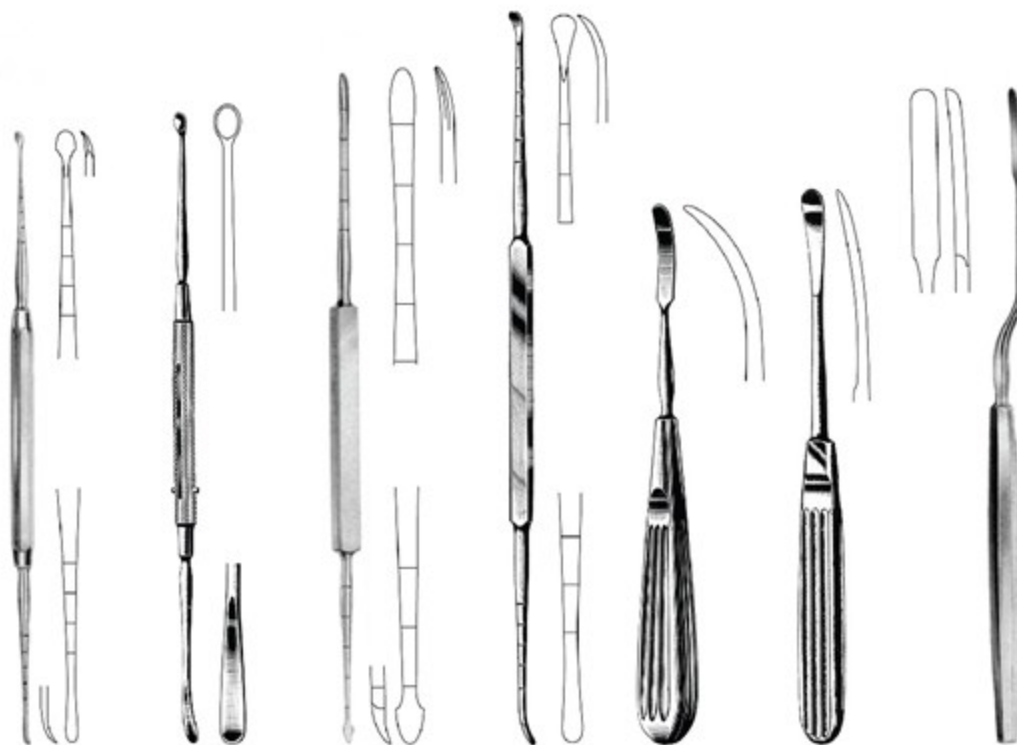

MASING
TBI 22-6717-21
21.0cm

CARTER
TBI 22-6718-21
21.0cm

COTTLE
TBI 22-6719-21
21.0cm

COTTLE
TBI 22-6720-22
22.0cm

JOSEPH
TBI 22-6721-16
16.0cm

COTTLE
TBI 22-6722-19
19.0cm

JOSEPH-MASING
TBI 22-6723-22
22.0cm





KILLIAN
TBI 22-6724-17
17.0cm



KILLIAN-CLAUS
TBI 22-6725-17
17.0cm

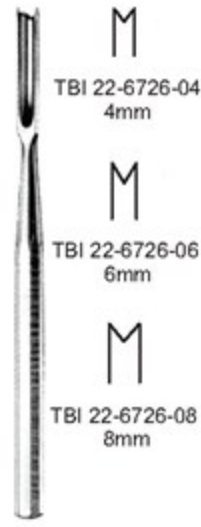

BALLENGER



FREER
TBI 22-6727-15
15.0cm



WEST
TBI 22-6728-16
16.0cm



WEST
TBI 22-6729-16
16.0cm



FREER
TBI 22-6730-16



FREER
TBI 22-6731-16

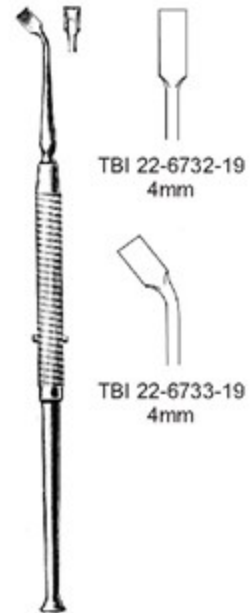

FREER



TBI 22-6734-17

TBI 22-6735-17

JOSEPH
17.0cm

JOSEPH
19.0cm

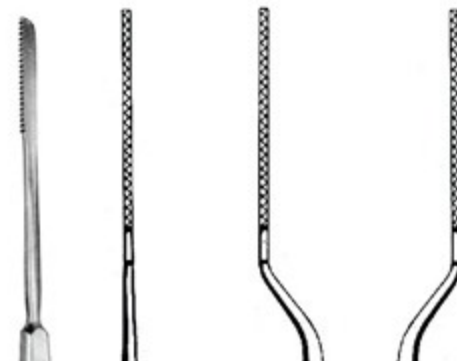

TBI 22-6736-01 TBI 22-6736-02 TBI 22-6736-03



SILVER
TBI 22-6737-18
18.0cm



SILVER
TBI 22-6738-18
18.0cm



SILVER
TBI 22-6739-18
18.0cm





COTTLE
TBI 22-6740-18
18.0cm

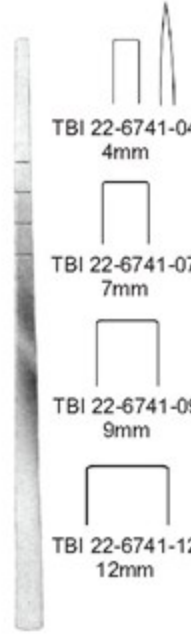

COTTLE
18.0cm

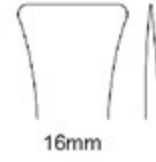

COTTLE
TBI 22-6742-18
18.0cm



COTTLE
TBI 22-6743-18
18.0cm

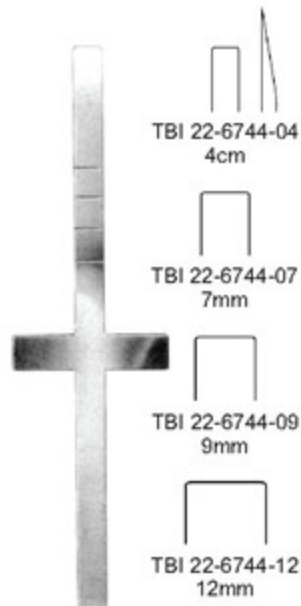
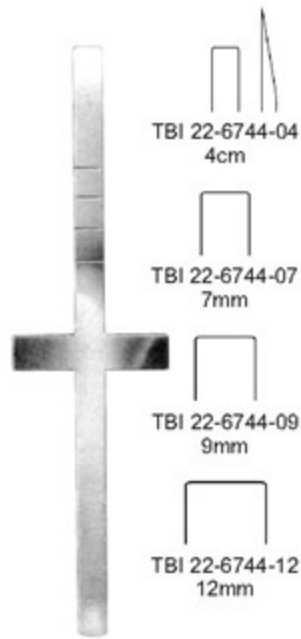

COTTLE
18.0cm

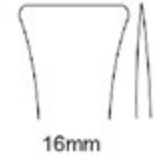

COTTLE
TBI 22-6745-18
18.0cm

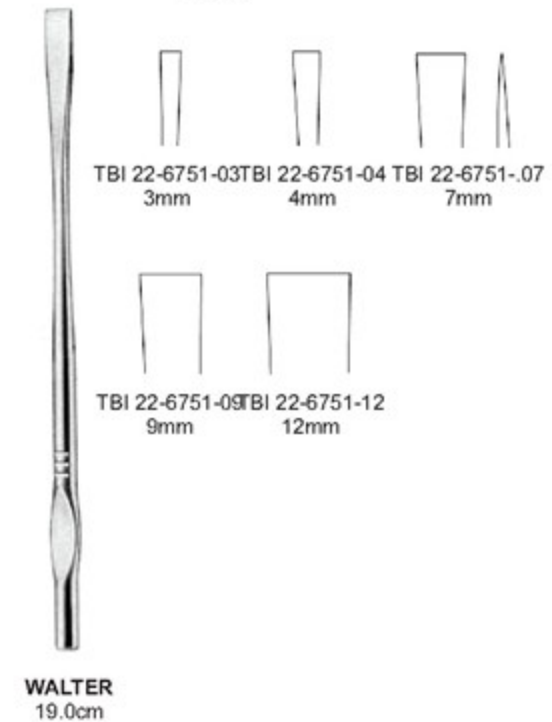
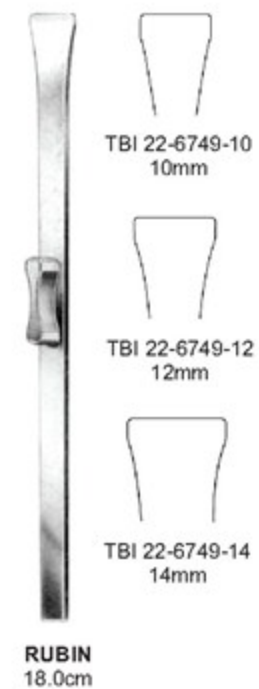
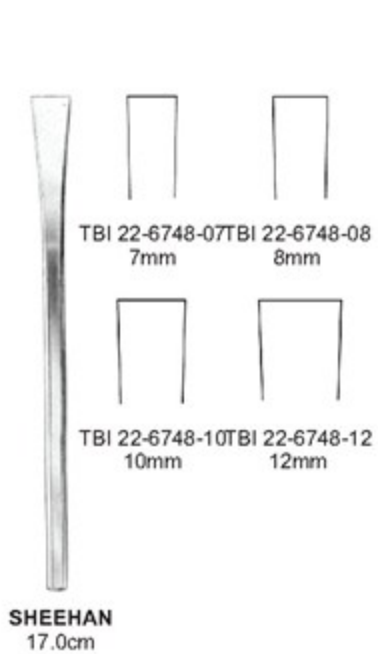
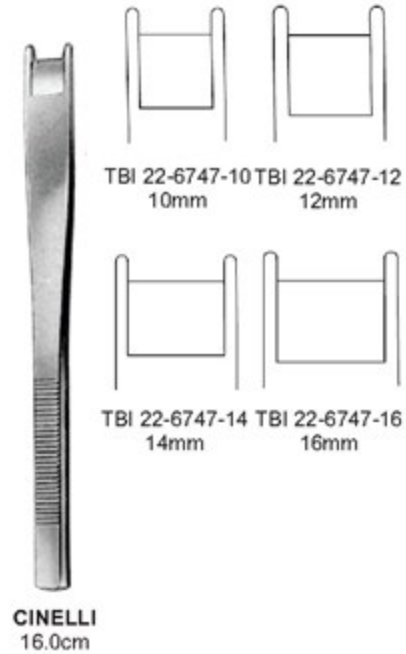
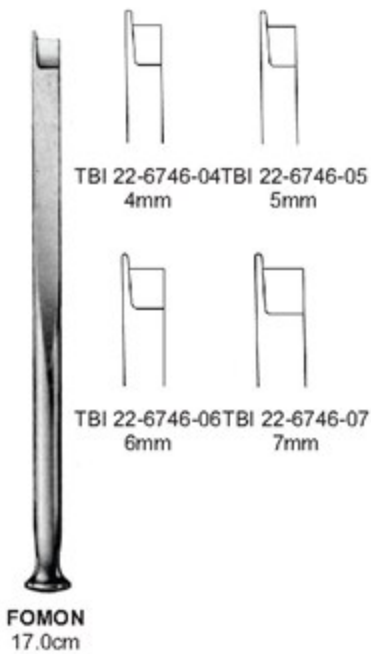

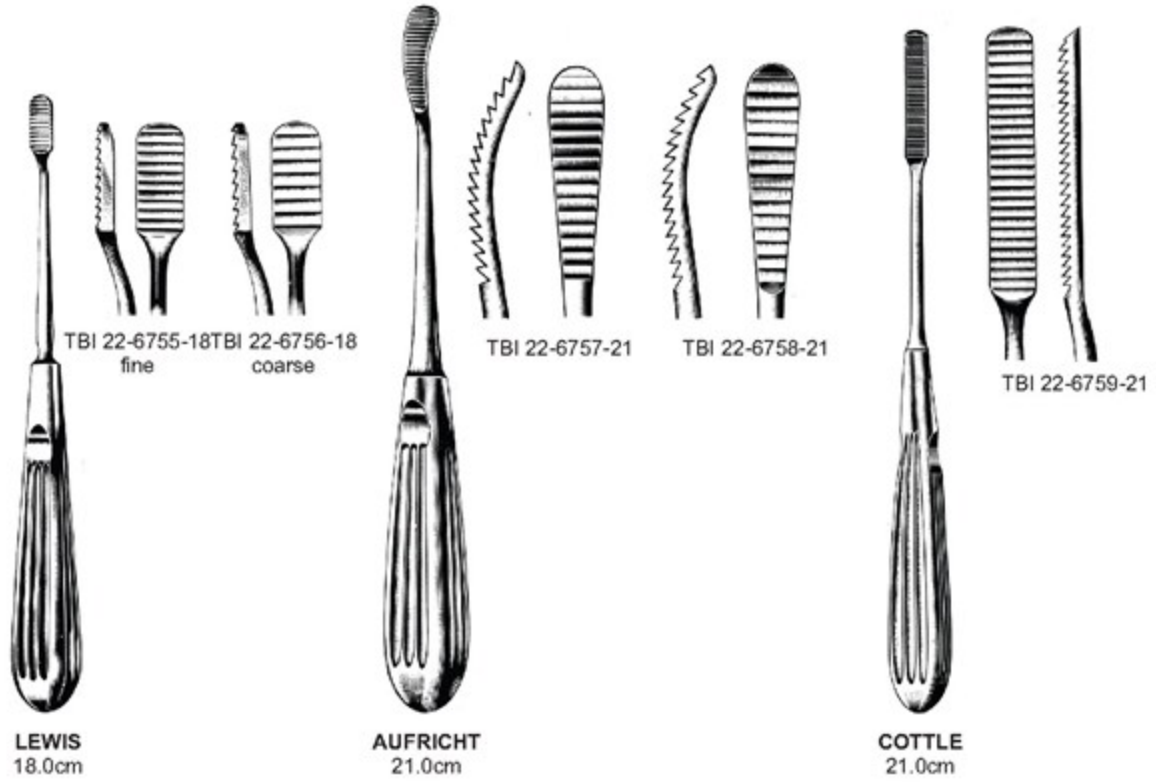
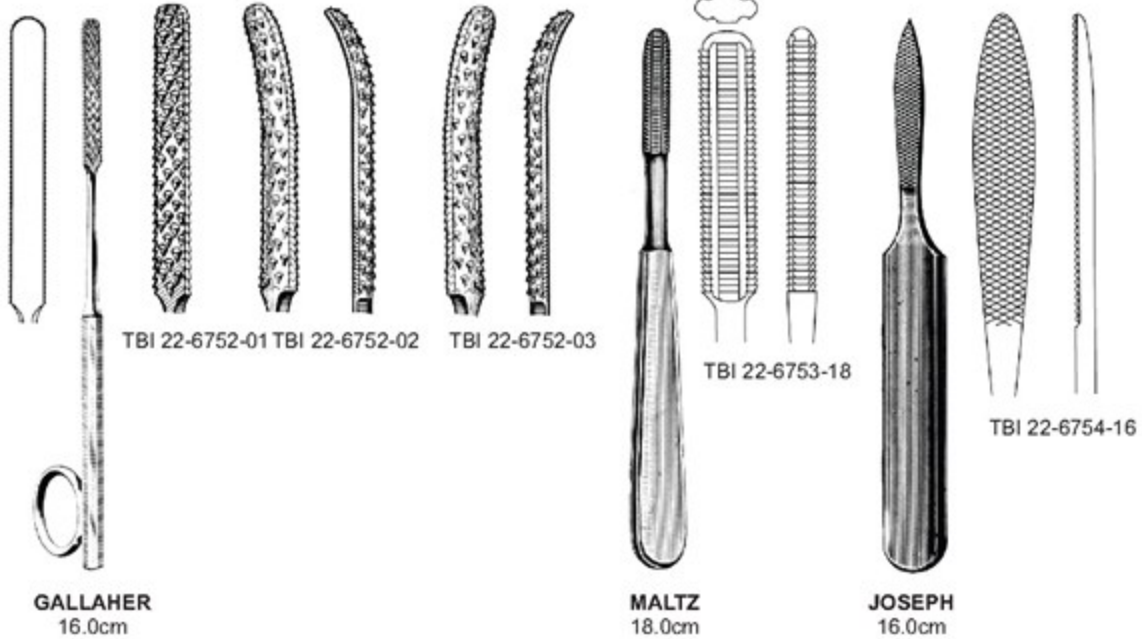



WIENER
18.0cm



TBI 22-6760-18



TBI 22-6761-18

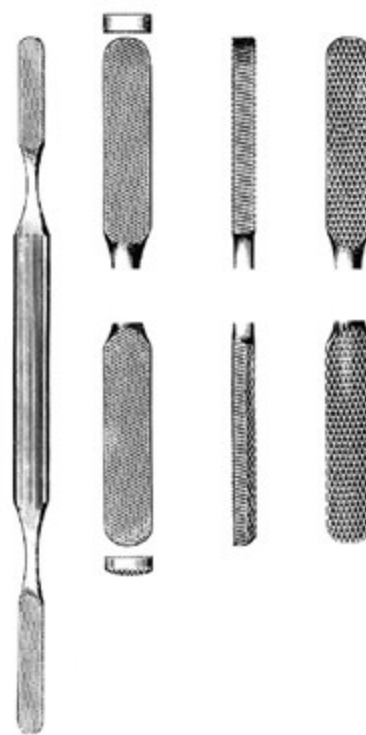

FOMON
TBI 22-6762-21
21.0cm





KILNER
TBI 22-6763-10
10.0cm



CONVERSE
TBI 22-6764-12
12.0cm



AUFRICT
TBI 22-6765-16
16.0cm



AUFRICT
TBI 22-6766-19
19.0cm



15.0cm



TBI 22-6767-01



TBI 22-6767-02



TBI 22-6767-03



LANGE
TBI 22-6768-22
22.0cm



FOMON
TBI 22-6769-17
17.0cm



COTTLE
TBI 22-6770-16
16.0cm



FREER
TBI 22-6771-15
15.0cm





OGURA
TBI 22-6772-11
11.0cm



COTLE
TBI 22-6773-11
11.0cm



COTLE
TBI 22-6774-14
14.0cm



COTLE
15.0cm



TBI 22-6775-14



TBI 22-6775-01



TBI 22-6775-02



FOMON
TBI 22-6776-16
16.0cm



COTLE-NEIVERT
TBI 22-6777-20
20.0cm





TBI 22-6778-01 TBI 22-6778-02 TBI 22-6778-03 TBI 22-6778-04 TBI 22-6778-05



TBI 22-6778-06 TBI 22-6778-07 TBI 22-6778-08 TBI 22-6778-09



YANKAUER



COTTLE
TBI 22-6779-14
14.0cm



NEIVERT
TBI 22-6780-16
16.0cm



COTTLE
TBI 22-6781-15
15.0cm



COTTLE
TBI 22-6782-15
15.0cm



AUFRICHT
TBI 22-6783-13
13.5cm



COAKLEY
 17.0cm



TBI 22-6784-01 TBI 22-6784-02 TBI 22-6784-03



TBI 22-6784-04 TBI 22-6784-05 TBI 22-6784-06



MYLES
 17.0cm



TBI 22-6785-01

TBI 22-6785-02

TBI 22-6785-03

TBI 22-6785-04

TBI 22-6785-05



TBI 22-6786-12
 12.0cm



PRATT
 TBI 22-6787-21
 21.0cm



FAULKNER
 TBI 22-6788-21
 21.0cm





KRESSNER
TBI 22-6789-20
20.0cm



ASCH
TBI 22-6790-23
23.0cm

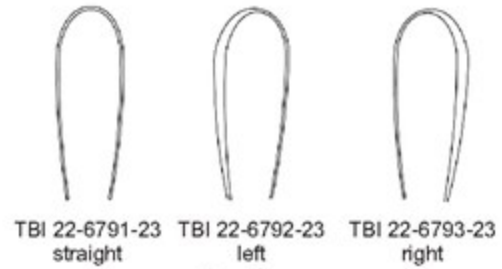

COTTLE-WALSHAM
23.0cm



BECKMANN
22.0cm



BECKMANN
22.0cm



TBI 22-6794-01
TBI 22-6795-01



TBI 22-6794-02
TBI 22-6795-02



TBI 22-6794-03
TBI 22-6795-03



TBI 22-6794-04
TBI 22-6795-04



TBI 22-6794-05
TBI 22-6795-05



TBI 22-6794-06
TBI 22-6795-06



BECKMANN
22.0cm



TBI 22-6796-01



TBI 22-6796-02



TBI 22-6796-03



TBI 22-6796-04



TBI 22-6796-05



ST. CLAIR-THOMSON
21.0cm



TBI 22-6797-08
8mm



TBI 22-6797-10
10mm



TBI 22-6797-12
12mm



TBI 22-6797-14
14mm



TBI 22-6797-16
16mm



TBI 22-6797-18
18mm





BRUENINGS-BRUNK
 TBI 22-6798-21
 21.5cm



LA FORCE
 25.0cm



1



2



3

with unperforated blade
 TBI 22-6799-01 Fig. 1
 TBI 22-6799-02 Fig. 2
 TBI 22-6799-03 Fig. 3

spare blades
 TBI 22-6801-01 Fig. 1
 TBI 22-6801-02 Fig. 2
 TBI 22-6801-03 Fig. 3

with perforated blade
 TBI 22-6800-01
 TBI 22-6800-02
 TBI 22-6800-03

TBI 22-6802-01
 TBI 22-6802-02
 TBI 22-6802-03

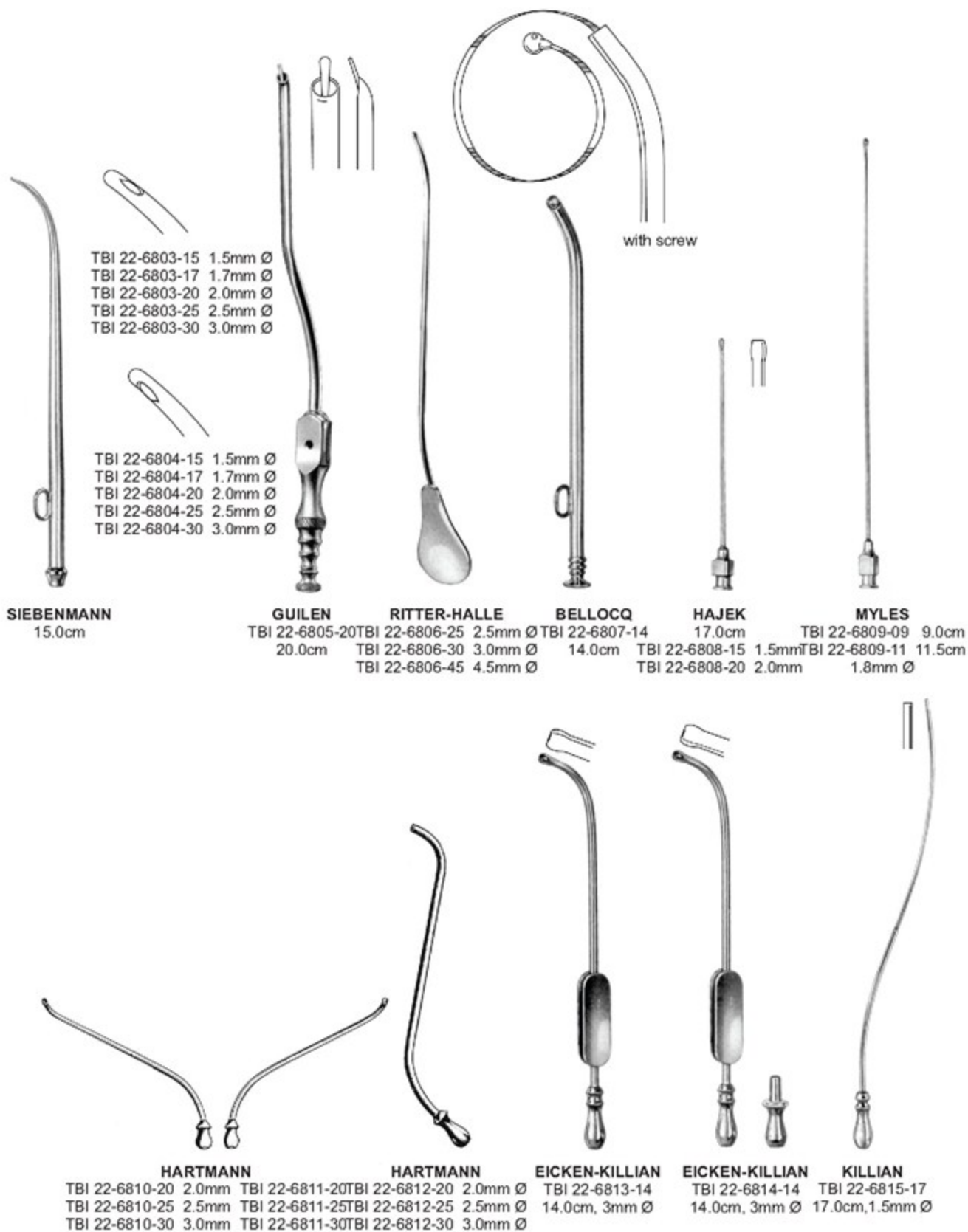

- EN** Oral Instruments
- DE** Mund instrumente
- ES** Cirugía oral

Page 575 to 594





16 mm
jaw

DENHART
TBI 23-6901-12
12 cm/4 3/4"



Silicon jaws
only (pair)
TBI 23-6903-12

DENHART
TBI 23-6902-12
12 cm/4 3/4"



ROSER-KONIG

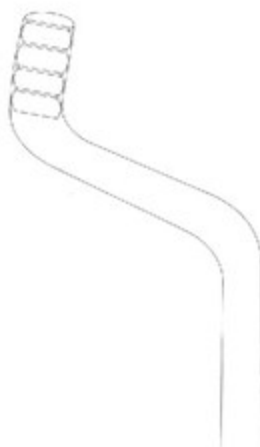

TBI 23-6904-16
16 cm/6 1/4"

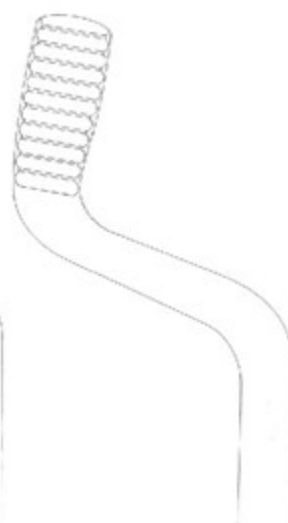

TBI 23-6904-19
19 cm/7 1/2"

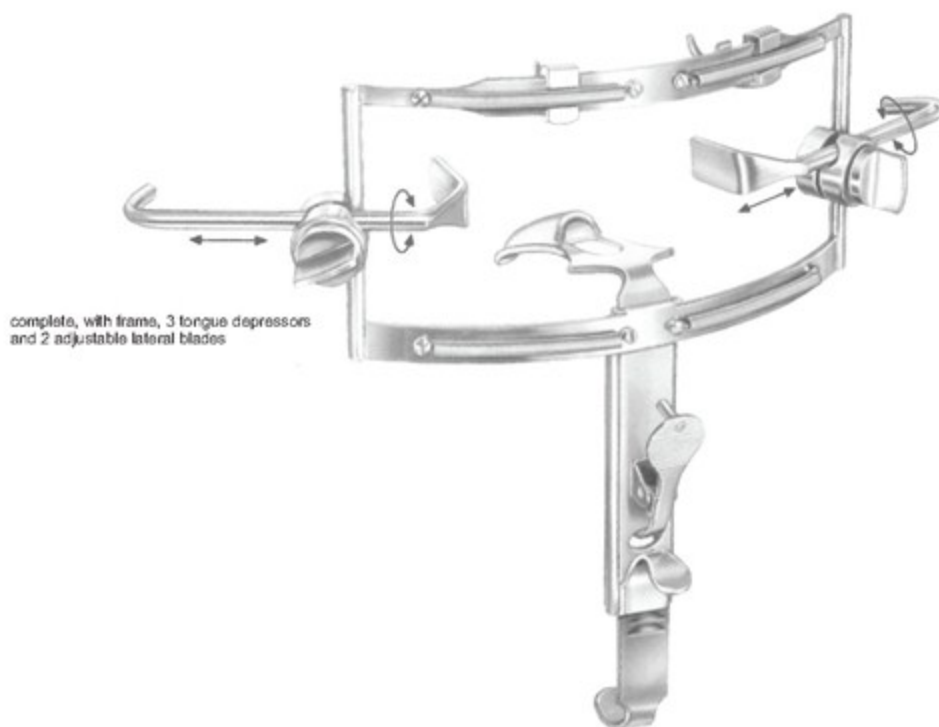

complete, with frame, 3 tongue depressors and 2 adjustable lateral blades

DINGMAN
 TBI 23-6905-00
 Complete set
 Fig. 1 - 3



TBI 23-6906-01
 62 mm x 26 mm



TBI 23-6907-02
 65 mm x 30 mm



TBI 23-6908-03
 78 mm x 32 mm

Tongue Depressors





HEISTER
TBI 23-6909-13
13 cm/5 1/4"



TBI 23-6911-11
Spare rubber

MOLT
TBI 23-6910-11
11 cm/4 3/8"



TBI 23-6913-13
Spare Rubber

MOLT
TBI 23-6912-13
13 cm/5 1/4"



SPREADING
47 mm

OBWEGESER
TBI 23-6914-11
11 cm/4 3/8"



WHITEHEAD

- TBI 23-6915-11 11 cm/ $\frac{3}{4}$ "
- TBI 23-6915-13 13 cm/ $\frac{1}{2}$ "
- TBI 23-6915-15 15 cm/ $\frac{5}{8}$ "



JENNINGS

- TBI 23-6916-09 9 cm/ $3 \frac{1}{2}$ "
- TBI 23-6916-11 11 cm/ $\frac{3}{4}$ "
- TBI 23-6916-13 13 cm/ $\frac{1}{2}$ "
- TBI 23-6916-15 15 cm/ $\frac{5}{8}$ "



TBI 23-6918-00
Frame for mouth gag

McLVOR
TBI 23-6917-00
Complete with 3
tongue depressors

Tongue Depressors

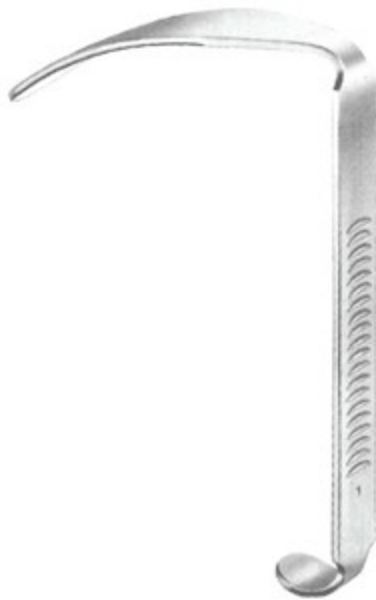

Fig. 1
TBI 23-6919-01
100 x 25 mm



Fig. 2
TBI 23-6920-02
85 x 25 mm



Fig. 3
TBI 23-6921-03
75 x 25 mm

TBI 23-6923-00
 Frame for mouth gag



DAVIS-BOYLE
 TBI 23-6922-00
 Complete, consisting of frame
 and 5 tongue depressors no. 1 - 5



with fixed suction tube

Fig. 1
 TBI 23-6924-01
 110 x 28 mm



Fig. 2
 TBI 23-6925-02
 95 x 27 mm



Fig. 3
 TBI 23-6926-03
 80 x 27 mm



Fig. 4
 TBI 23-6927-04
 65 x 26 mm



Fig. 5
 TBI 23-6928-05
 30 x 20 mm



KILNER-DOUGHTY
TBI 23-6930-00



complete, consisting of frame and 3 tongue depressors
no. 1 to 3, 2 tooth plates and 1 palate plate

NEUKAM
 TBI 23-6937-00
 frame for mouth gag only



NEUKAM
 TBI 23-6936-00
 complete with frame and
 3 tongue depressors

Tongue Depressor
 fenestrated blade for suction



Fig. 1
 TBI 23-6938-01

Fig. 2
 TBI 23-6939-02

Fig. 3
 TBI 23-6940-03



COLLIN
 TBI 23-6941-16 16 cm/6 1/4"
 TBI 23-6941-18 18 cm/7 1/8"



YOUNG
 TBI 23-6942-16
 16 cm/6 1/4"



TBI 23-6943-16
 rubber inserts, only (pair)



TBI 23-6944-15
 15 cm/5 1/4"
 wood
 19 mm



TBI 23-6945-15
 15 cm/5 1/4"
 plastic



BRUNINGS
 TBI 23-6946-19
 19 cm/7 1/2"



TBI 23-6947-14
 14.5 cm/5 3/4"



TBI 23-6948-14
 14 cm/5 1/2"



DOYEN

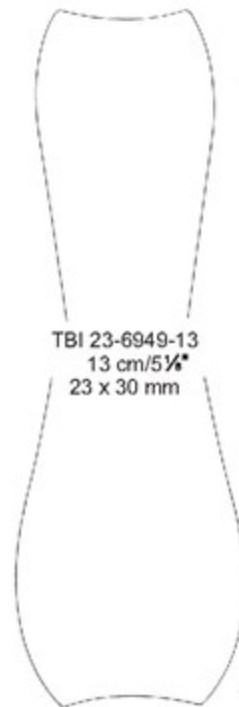

TBI 23-6949-13
 13 cm/5 1/4"
 23 x 30 mm

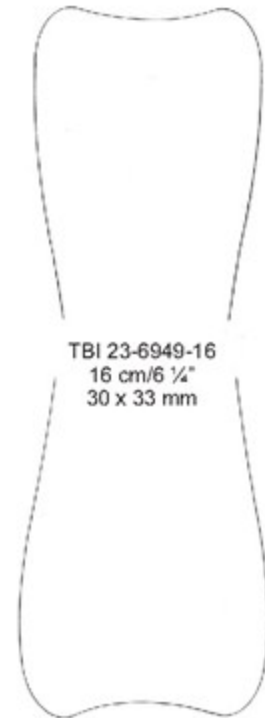

TBI 23-6949-16
 16 cm/6 1/4"
 30 x 33 mm



TOBOLD
TBI 23-6950-15
15 cm/5 1/4"

80 x 25 mm

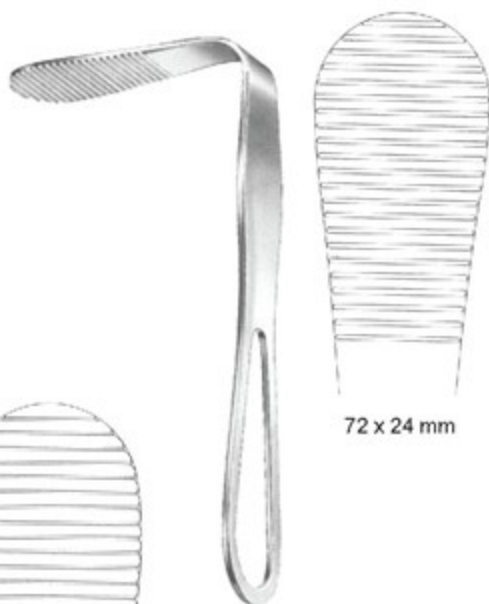

HARTMANN
TBI 23-6951-15
15 cm/5 1/4"

72 x 24 mm



TOBOLD
TBI 23-6952-16
16 cm/6 1/4"

83 x 25 mm



BUCHWALD
TBI 23-6953-18
18 cm/7 1/4"



ANDREW
TBI 23-6954-11
11 cm/4 3/8"

WIEDER

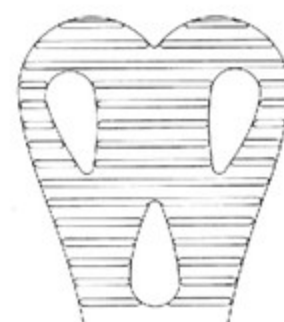

TBI 23-6955-14
14 cm/5 1/2"
36 mm



TBI 23-6955-15
15 cm/5 1/4"
43 mm



MARTIN-SIMPLEX
 TBI 23-6956-10
 10.5 cm/4 1/4"



TBI 23-6957-14
 14 cm/5 1/2"
 Vestibulum retractor



STERNBERG
 TBI 23-6958-14
 14 cm/5 1/2"

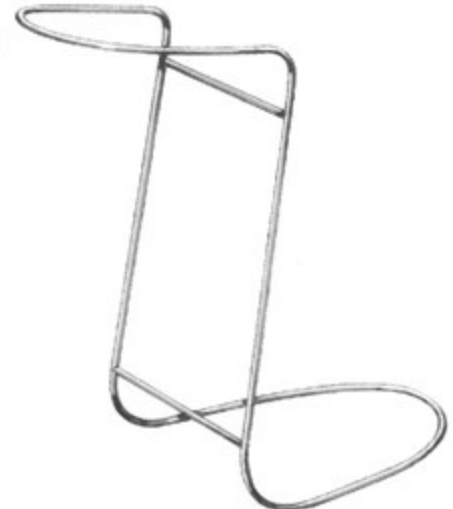

OBWEGESER
 TBI 23-6959-12
 12 cm/4 3/4"



BISHOP
 TBI 23-6960-13
 13.5 cm/5 3/8"



CAWOOD-MINNESOTA
 TBI 23-6961-15
 15.5 cm/6 1/8"



CAWOOD-MINNESOTA
 TBI 23-6962-14
 14.5 cm/5 3/4"



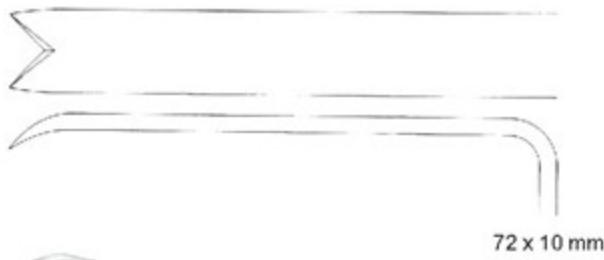

OBWEGESER
TBI 23-6963-22
22 cm/8 3/4"



OBWEGESER
TBI 23-6964-16
16.5 cm/6 1/2"



TBI 23-6965-16
16 cm/6 1/4"
8 mm

TBI 23-6966-16
16 cm/6 1/4"
10 mm

OBWEGESER





TBI 23-6967-22
 22.5 cm/8 7/8"
 43 x 11 mm



TBI 23-6967-23
 23 cm/9"
 57 x 11 mm



TBI 23-6968-23
 23 cm/9"
 80 x 16 mm

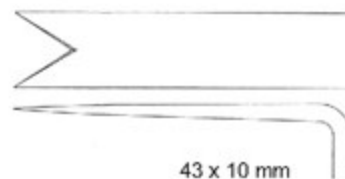

43 x 10 mm



OBWEGESER



OBWEGESER
 TBI 23-6969-22
 22 cm/8 7/8"
 Nasal Spine Retractor



OBWEGESER
17.5 cm/6 7/8"



TBI 23-6970-17



TBI 23-6971-17



KRENKEL
24.5 cm/9 5/8"



TBI 23-6972-24
Periosteal Elevator



TBI 23-6973-24
Periosteal Elevator



TBI 23-6974-24
Condylar repositioning
instrument
Fig. 11



TBI 23-6975-24
Fig. 12





OBWEGESER
17.5 cm/6 7/8"



TBI 23-6976-17
6 mm



TBI 23-6977-17
7 mm



TBI 23-6978-17
9 mm



TBI 23-6979-17



OBWEGESER
20 cm/7 7/8"



TBI 23-6980-20
5 mm



TBI 23-6981-20
7 mm



TBI 23-6982-20
9 mm



OBWEGESER
 TBI 23-6983-20
 20.5 cm/8 1/4"



OBWEGESER
 TBI 23-6984-20
 20.5 cm/8 1/4"



OBWEGESER
 15 cm/5 7/8"



TBI 23-6985-15
 2.5 mm



TBI 23-6986-15
 4.0 mm



TBI 23-6987-15
 6.5 mm

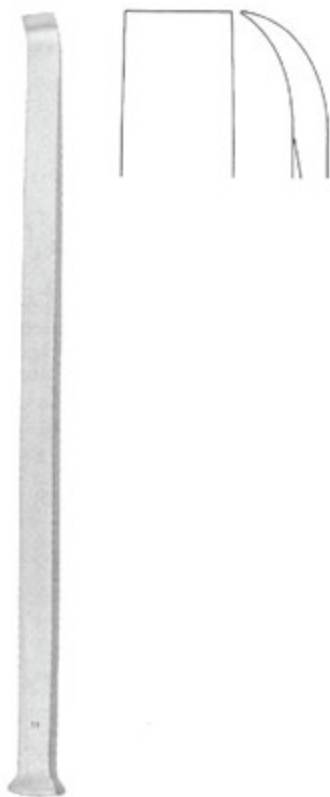

OBWEGESER
 TBI 23-6988-23
 23.5 cm/9 1/4"



TBI 23-6989-18



TBI 23-6990-18

OBWEGESER
 18.5 cm/7 1/4"



OBWEGESER
 TBI 23-6991-18
 18 cm/7 1/8"



OBWEGESER
 TBI 23-6992-14
 14 cm/5 1/2"



OBWEGESER
 TBI 23-6993-23
 23 cm/9"



Awl for lower jaw

KELSEY-FRY
TBI 23-6994-15
15 cm/5 7/8"



Awl for upper jaw

KELSEY-FRY
TBI 23-6995-18
18 cm/7 1/8"

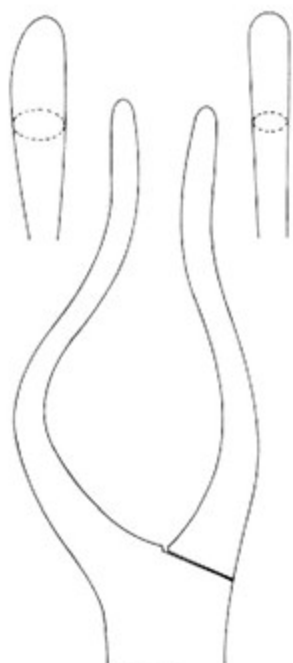

Fig. 1
for babies

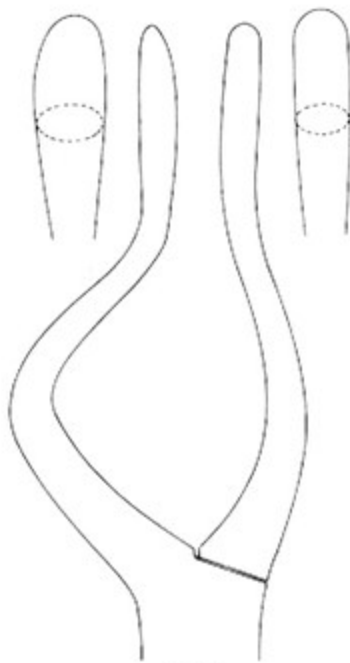

Fig. 2
for children

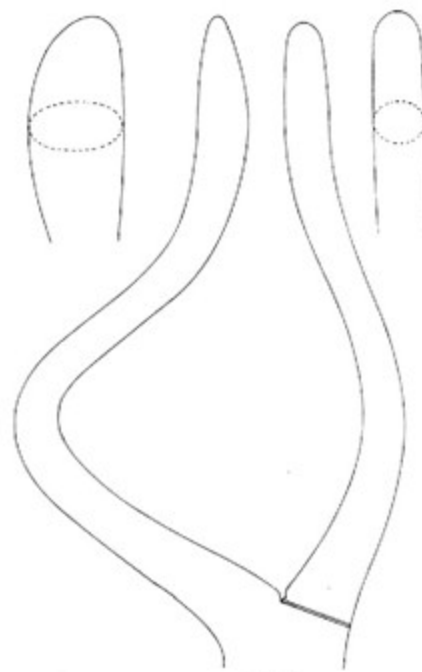

Fig. 3
for adults



Left

ROWE

TBI 23-6996-22 Fig. 1 22.5 cm
 TBI 23-6996-23 Fig. 2 23.5 cm
 TBI 23-6996-24 Fig. 3 24.0 cm



Right

ROWE

TBI 23-6997-22 Fig. 1 22.5 cm
 TBI 23-6997-23 Fig. 2 23.5 cm
 TBI 23-6997-24 Fig. 3 24.0 cm

- EN** Stomach, Intestine, Rectum
DE Magen, Darm, Mastdarm
ES Estómago, Intestinos, Recto

Page 595 to 619

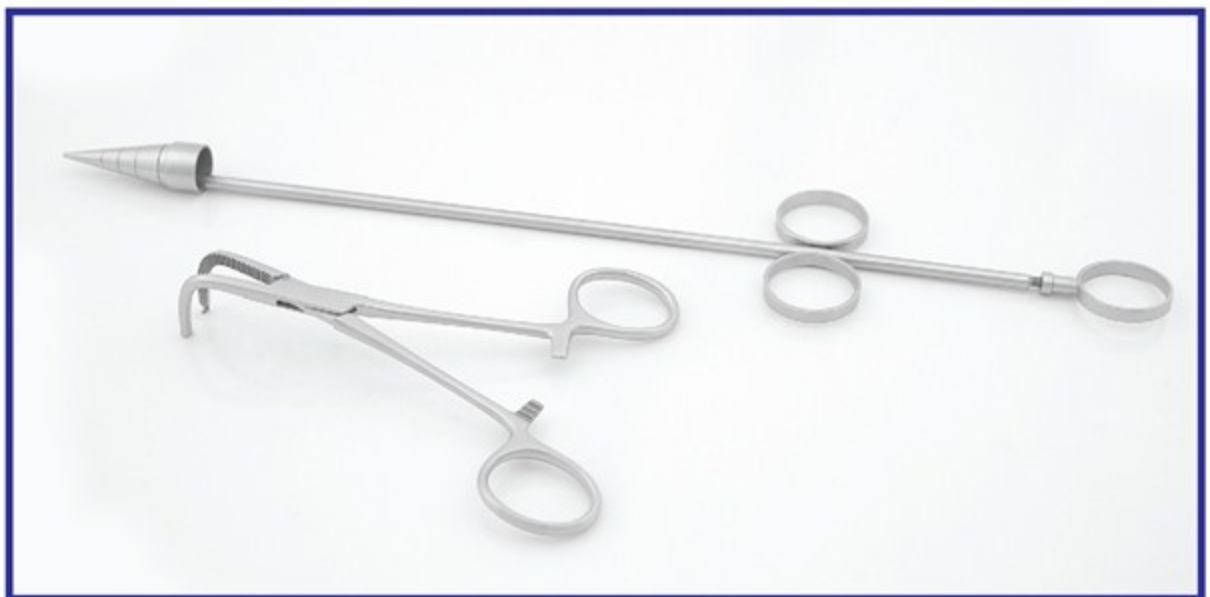



Allis

cm	in	4 : 5	5 : 6
15	6"	TBI 24-7101-15	TBI 24-7102-15
19	7½"	TBI 24-7101-19	TBI 24-7102-19
23	9"	TBI 24-7101-23	TBI 24-7102-23
25	10"	TBI 24-7101-25	TBI 24-7102-25



Baby-Allis

TBI 24-7103-12	12 cm/4¾"
TBI 24-7103-14	14 cm/5½"



Allis-Atrauma

TBI 24-7104-16	16 cm/6¼"
TBI 24-7104-20	20 cm/8"
TBI 24-7104-25	25 cm/10"
TBI 24-7104-30	30 cm/12"



Allis-Adair
TBI 24-7105-15
15 cm/6"



Boys-Allis
TBI 24-7106-15
15 cm/6"



Lockwood-Allis
TBI 24-7107-16 16 cm/6¼"
TBI 24-7107-20 20 cm/8"



Thoms-Allis
TBI 24-7108-20
20 cm/8"



Judd-Allis
 TBI 24-7109-15 15 cm/6"
 TBI 24-7109-19 19 cm/7 1/2"



Littlewood
 TBI 24-7110-18
 18.5 cm/7 1/4"



Williams
 TBI 24-7111-16
 16 cm/6 1/4"



Lockwood
 TBI 24-7112-20
 20 cm/8"

Atrauma



cm/in
 16 cm/6 1/4" **Babcock-Atrauma**
 18 cm/7" TBI 24-7113-16
 20 cm/8" TBI 24-7113-20
 24 cm/9 1/2"



Babcock(Standard)
 TBI 24-7114-16
 TBI 24-7114-18
 TBI 24-7114-20
 TBI 24-7114-24



Baby-Babcock
 TBI 24-7115-16



Babcock
 TBI 24-7116-16
 TBI 24-7116-18
 TBI 24-7116-20
 TBI 24-7116-24





Atrauma



TBI 24-7117-18
18 cm/7"



TBI 24-7117-20
20 cm/8"



TBI 24-7117-23
23 cm/9"



Duval		
cm	in	
TBI 24-7118-18	18	7" TBI 24-7119-18
TBI 24-7118-20	20	8" TBI 24-7119-20
TBI 24-7118-23	23	9" TBI 24-7119-23



TBI 24-7119-18
TBI 24-7119-20
TBI 24-7119-23



Duval
TBI 24-7120-20
20 cm/8"



TC



Child
TBI 24-7121-24
24 cm/9½"



TBI 24-7121-00
Pair

Atrauma



TBI 24-7122-25
25 cm/10"



TBI 24-7122-26
26 cm/10¼"

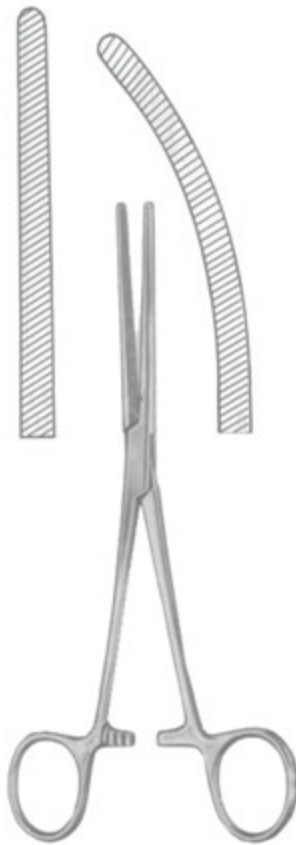

Baby-Doyen
 Straight TBI 24-7123-18 18 cm/7"
 Curved TBI 24-7124-18 18 cm/7"

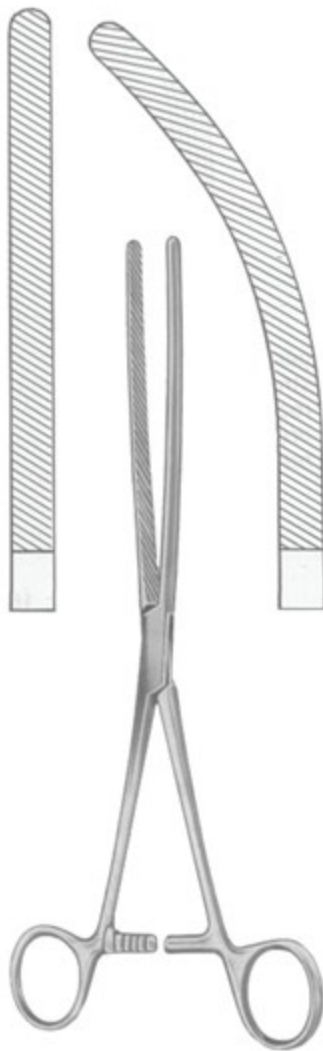

Doyen
 Straight TBI 24-7125-21 21 cm/8" *
 Curved TBI 24-7126-21 21 cm/8" *
 TBI 24-7125-23 23 cm/9" TBI 24-7126-23 23 cm/9"

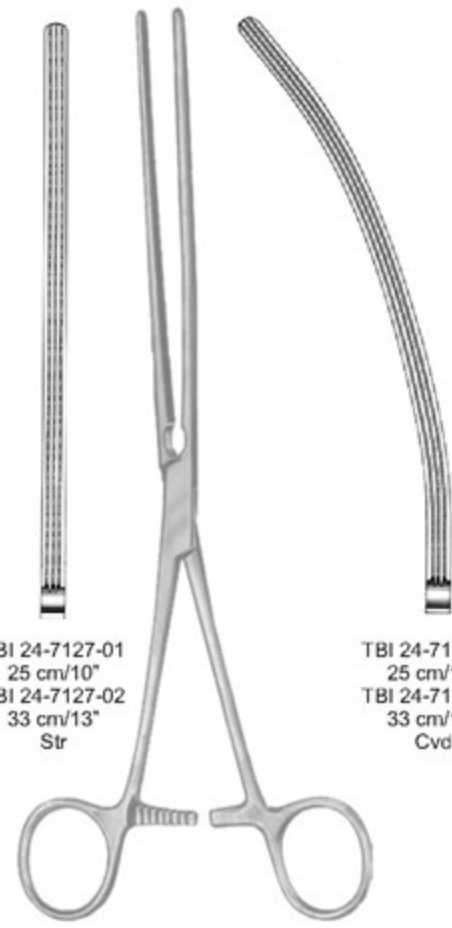

TBI 24-7127-01 25 cm/10"
 TBI 24-7127-02 33 cm/13" Str
 TBI 24-7127-03 25 cm/10"
 TBI 24-7127-04 33 cm/13" Cvd

Scudder





Doyen-Atrauma

Atrauma

Straight

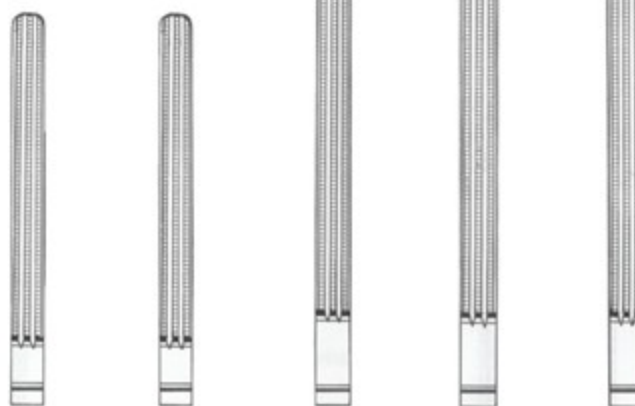

TBI 24-7128-13 13 cm/5"
 TBI 24-7128-16 16 cm/6¼"
 TBI 24-7128-18 18 cm/7"
 TBI 24-7128-21 21 cm/8¼"
 TBI 24-7128-23 23 cm/9"

Curved

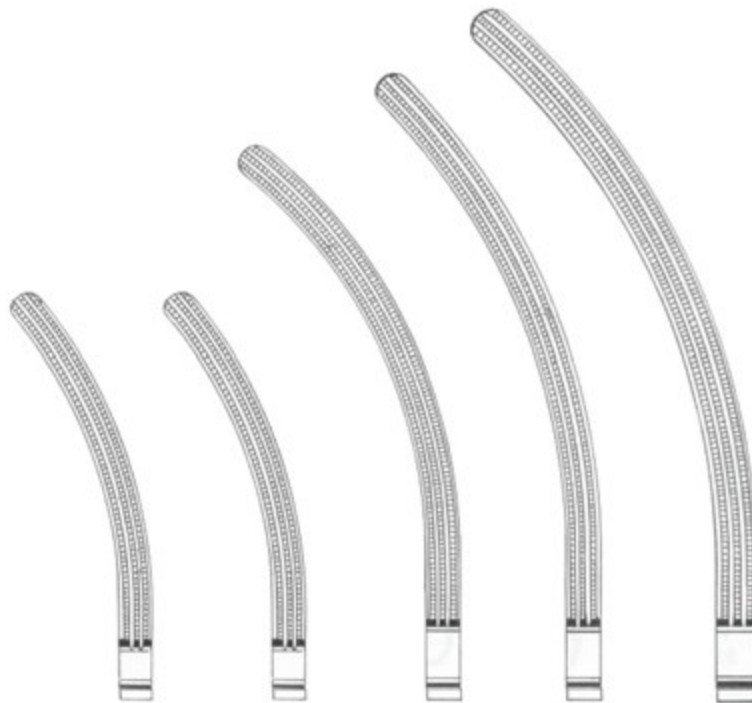

TBI 24-7129-13 13 cm/5"
 TBI 24-7129-16 16 cm/6¼"
 TBI 24-7129-18 18 cm/7"
 TBI 24-7129-21 21 cm/8¼"
 TBI 24-7129-23 23 cm/9"



Atrauma



Mayo-Robson
 Mayo-Robson Atrauma



TBI 24-7130-21
 21 cm/8 1/4"



TBI 24-7131-21
 21 cm/8 1/4"



TBI 24-7132-23
 23 cm/9"



TBI 24-7133-23
 23 cm/9"



TBI 24-7134-25
 25 cm/10"



TBI 24-7135-25
 25 cm/10"



TBI 24-7136-25
 25 cm/10"



TBI 24-7137-25
 25 cm/10"



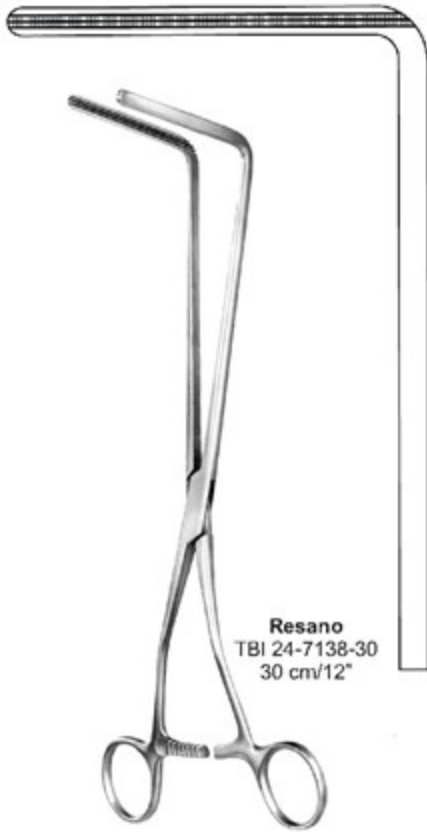

Atrauma



TBI 24-7140-28
28 cm/11"

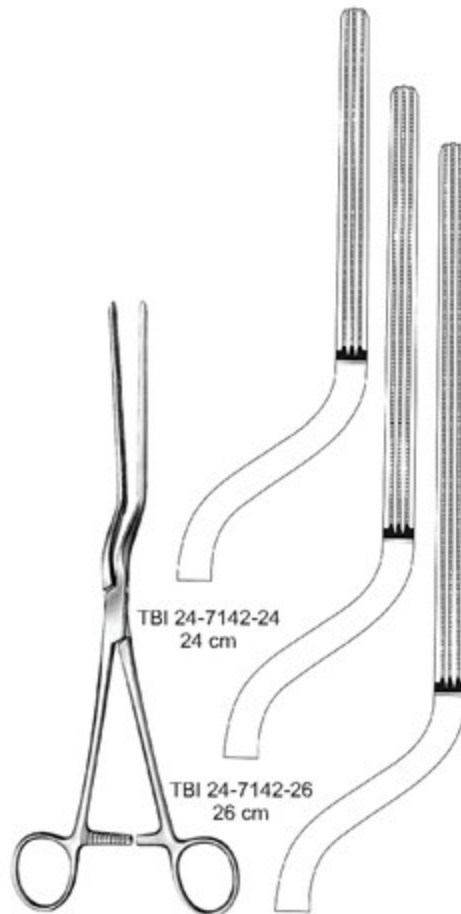

STOMACH, INTESTINE & RECTUM



Straight **Baby-Kocher** Curved
 TBI 24-7144-13 TBI 24-7145-13
 13 cm/5" 13 cm/5"



Kocher



TBI 24-7146-22 TBI 24-7146-25 TBI 24-7146-28 TBI 24-7147-22 TBI 24-7147-25 TBI 24-7147-28
 22 cm/8 3/4" 25 cm/10" 28 cm/11" 22 cm/8 3/4" 25 cm/10" 28 cm/11"





Atrauma



Kocher-Atrauma

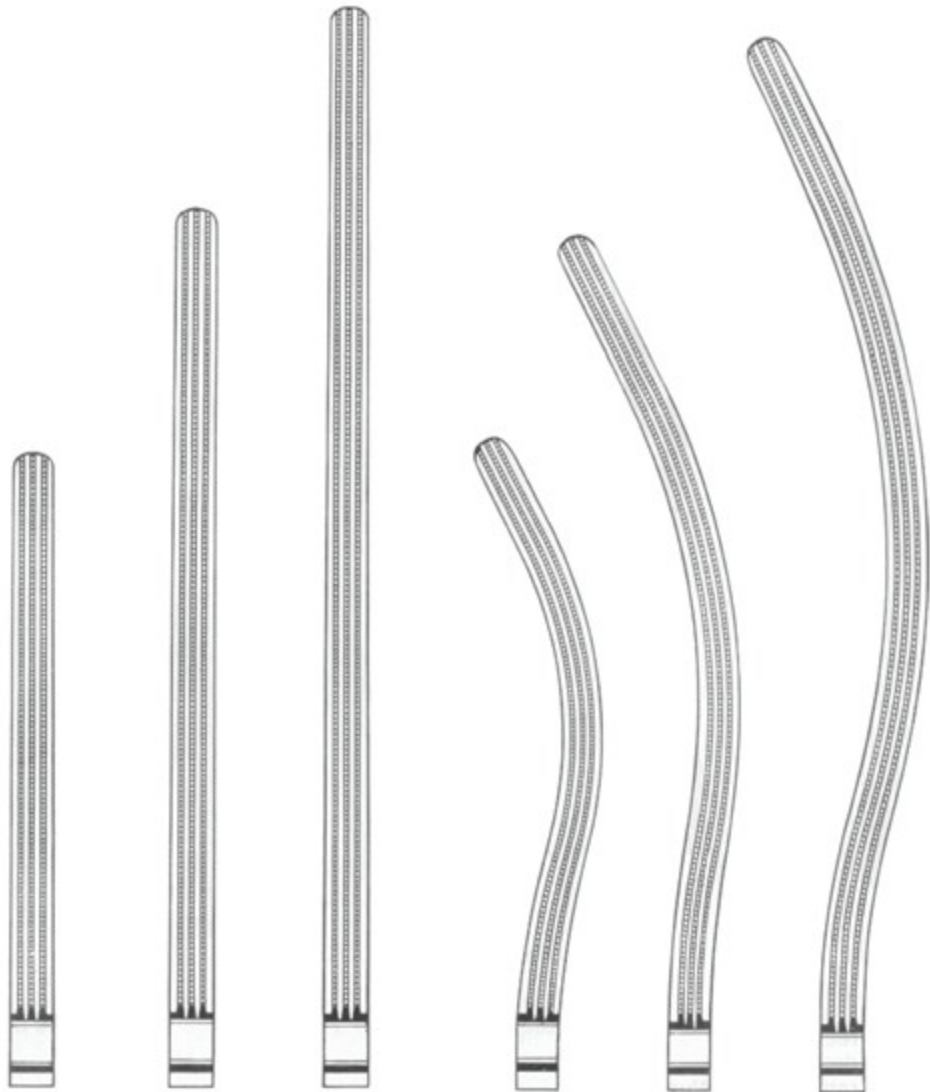

TBI 24-7148-22	TBI 24-7148-25	TBI 24-7148-28	TBI 24-7149-22	TBI 24-7149-25	TBI 24-7149-28
22 cm/8 3/4"	25 cm/10"	28 cm/11"	22 cm/8 3/4"	25 cm/10"	28 cm/11"



Straight
 TBI 24-7151-25
 TBI 24-7151-30



Nussbaum
 25 cm/10"
 30 cm/12"



Curved
 TBI 24-7152-25
 TBI 24-7152-30



Pylorus spreader

Benson
 TBI 24-7150-15
 15.5 cm/6"



Allen
 TBI 24-7153-15 15.5 cm/6"
 TBI 24-7153-20 20.0 cm/8"



Kleinschmidt
 TBI 24-7154-12
 12 cm/4 3/4"

Blindgut forceps





Payr
(Payr-Baby)

For children

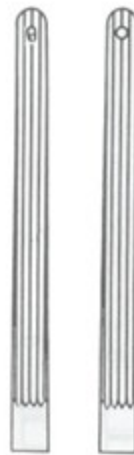

TBI 24-7155-15
15 cm/6"



TBI 24-7156-21
21 cm/8 1/4"

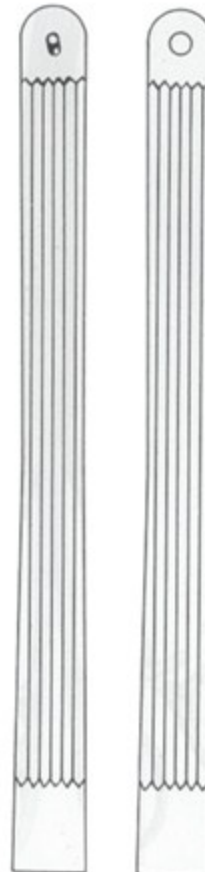

TBI 24-7157-29
29 cm/11 1/2"

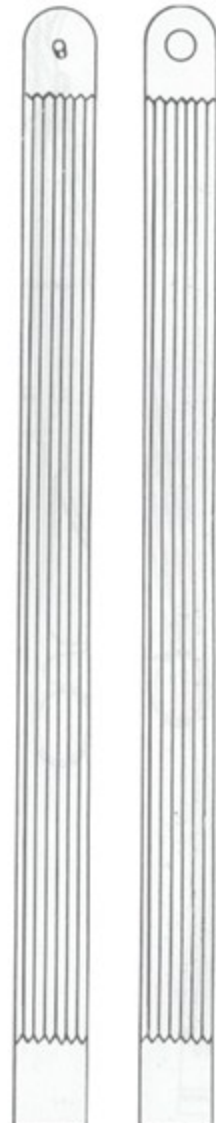

TBI 24-7158-35
35 cm/13 3/4"

Intestinal Clamps Forceps — EN
Darmklemmen — DE
Pinzas-clamps intestinales — ES



Lane
30 cm/12"



Twin Clamps Forceps



Straight
TBI 24-7159-30

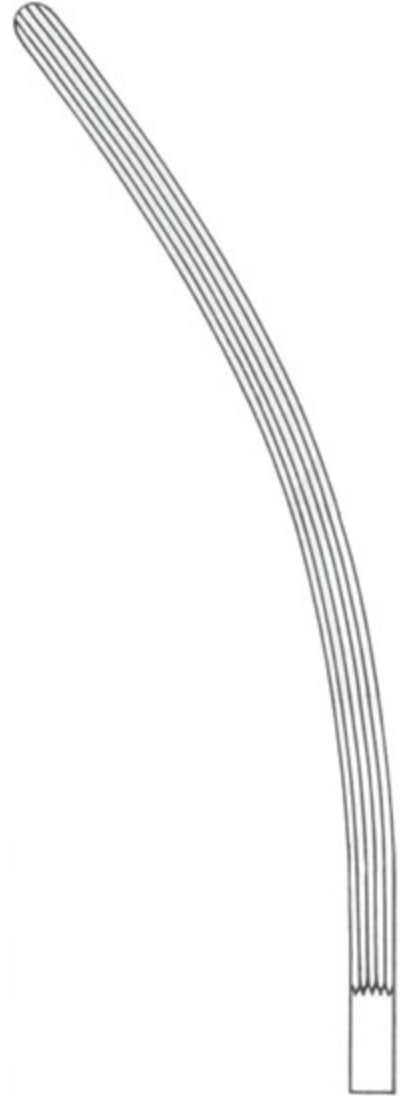

Curved
TBI 24-7160-30



- EN —● Stomach Clamps Forceps
- DE —● Magenklennen
- ES —● Pinzas-clamps estomacales

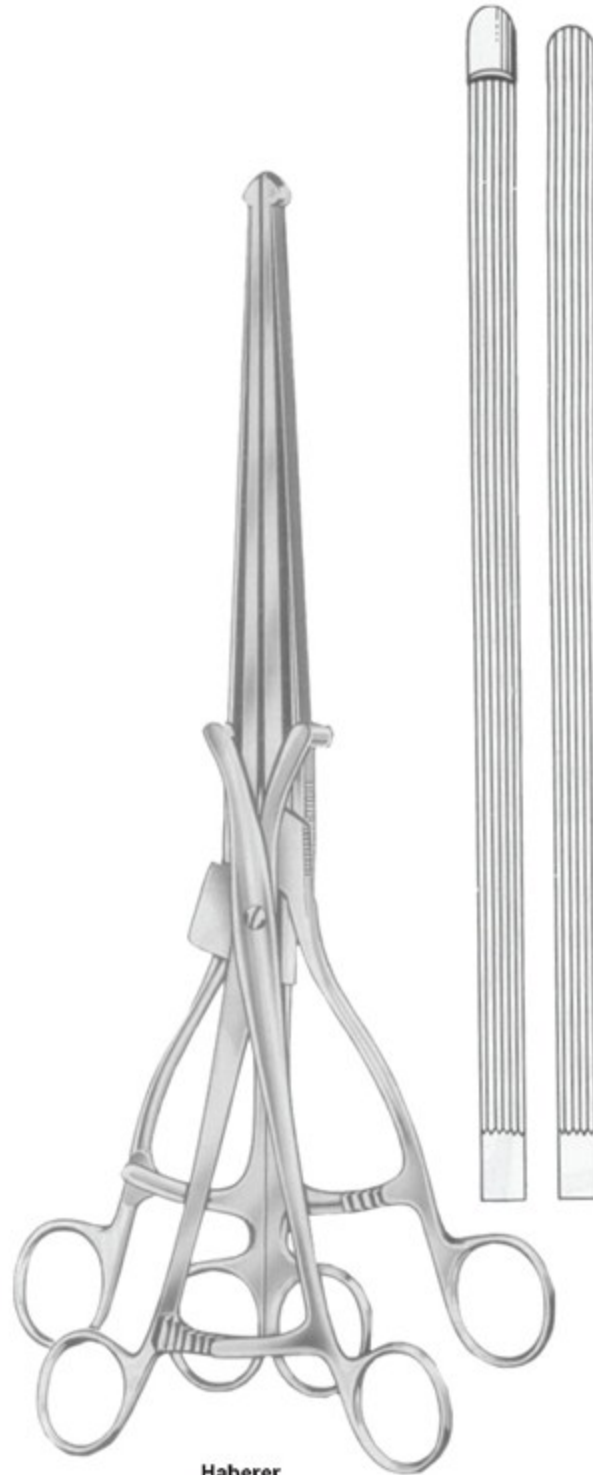

Haberer
TBI 24-7161-36
36 cm/14"



SIMS
 TBI 24-7162-15
 15.0cm



SIMS
 TBI 24-7163-15
 15.0cm



MATHIEU
 TBI 24-7164-19
 19.5cm



SIMS
 TBI 24-7165-15
 15.0cm



SCHULZE-BERGMANN
 22.0cm
 TBI 24-7166-06 60mm
 TBI 24-7166-08 80mm
 TBI 24-7166-12 125mm
 TBI 24-7166-15 150mm



PRATT
 TBI 24-7167-21
 21.5cm



RICORD
 TBI 24-7168-00





KELLY
TBI 24-7169-01 21mm Ø x 50mm
TBI 24-7169-02 27mm Ø x 50mm

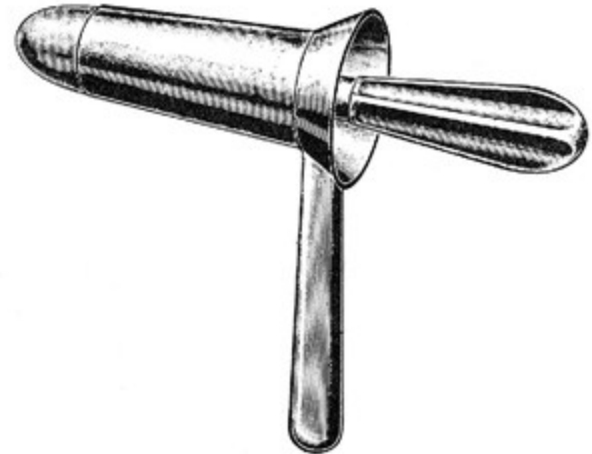

KELLY
TBI 24-7170-01 25mm Ø x 64mm
TBI 24-7170-02 22mm Ø x 35mm



GRAEME-ANDERSON
TBI 24-7171-00
24mm Ø x 64mm



GABRIEL
TBI 24-7172-01 24mm Ø x 64mm
TBI 24-7172-02 19mm Ø x 49mm



KELLY

- TBI 24-7173-01 22mm Ø x 50mm
- TBI 24-7173-02 22mm Ø x 100mm
- TBI 24-7173-03 22mm Ø x 140mm
- TBI 24-7173-04 22mm Ø x 200mm



IVES-FANSLER

- TBI 24-7174-15
 22mm Ø



HIRSCHMANN

- TBI 24-7175-01 16mm Ø x 65mm
- TBI 24-7175-02 19mm Ø x 65mm
- TBI 24-7175-03 22mm Ø x 65mm



KELLY

- TBI 24-7176-01 22mm Ø x 50mm
- TBI 24-7176-02 22mm Ø x 100mm
- TBI 24-7176-03 22mm Ø x 140mm



- EN — Anusopes, Proctoscopes and Sphincteroscopes
 DE — Sphinkterskope, Anuskope, Proktoskope
 ES — Esfinteroscopios, Anoscopios, Proctoscopios

**MOD. MARTIN**

TBI 24-7177-01 22mm Ø X 50mm
 TBI 24-7177-02 22mm Ø X 75mm
 TBI 24-7177-03 22mm Ø X 100mm

**NEWMAN**

TBI 24-7178-01 16mm Ø X 63mm
 TBI 24-7178-02 19mm Ø X 63mm
 TBI 24-7178-03 23mm Ø X 63mm

**BENSAUDE**

TBI 24-7179-01 19mm Ø X 70mm
 TBI 24-7179-02 22mm Ø X 70mm

**NAUNTON-MORGAN**

TBI 24-7180-00
 22mm Ø X 70mm



BARR
 TBI 24-7181-17
 17.0cm



SMITH-BUIE
 TBI 24-7182-15
 15.0cm



ALAN PARKS
 13.5cm
 TBI 24-7183-00 complete
 TBI 24-7183-04 centre blade
 TBI 24-7183-13 frame only



TBI 24-7183-01
 72mm



TBI 24-7183-02
 90mm



TBI 24-7183-03
 94mm



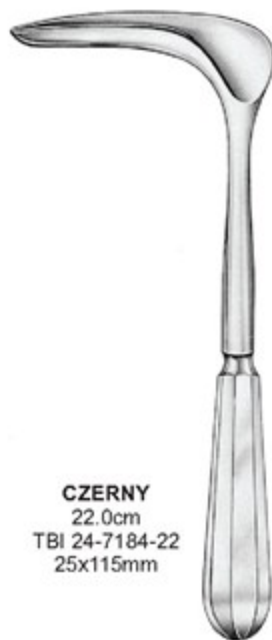

CZERNY
22.0cm
TBI 24-7184-22
25x115mm



SAWYER
23.0cm
TBI 24-7185-01 65x22mm
TBI 24-7185-02 75x28mm
TBI 24-7185-03 90x38mm



FERGUSON-MOON
21.0cm
TBI 24-7186-01 65x22mm
TBI 24-7186-02 75x28mm



BUIE
13.5cm
TBI 24-7187-13 light
TBI 24-7188-13 heavy



LARRY
TBI 24-7189-18
18.0cm



ROSER
TBI 24-7190-17
17.0cm



PRATT
22.0cm



TBI 24-7191-01

TBI 24-7191-02

TBI 24-7191-03



BARR
TBI 24-7192-23
23.0cm



BARR
TBI 24-7193-14
14.0cm

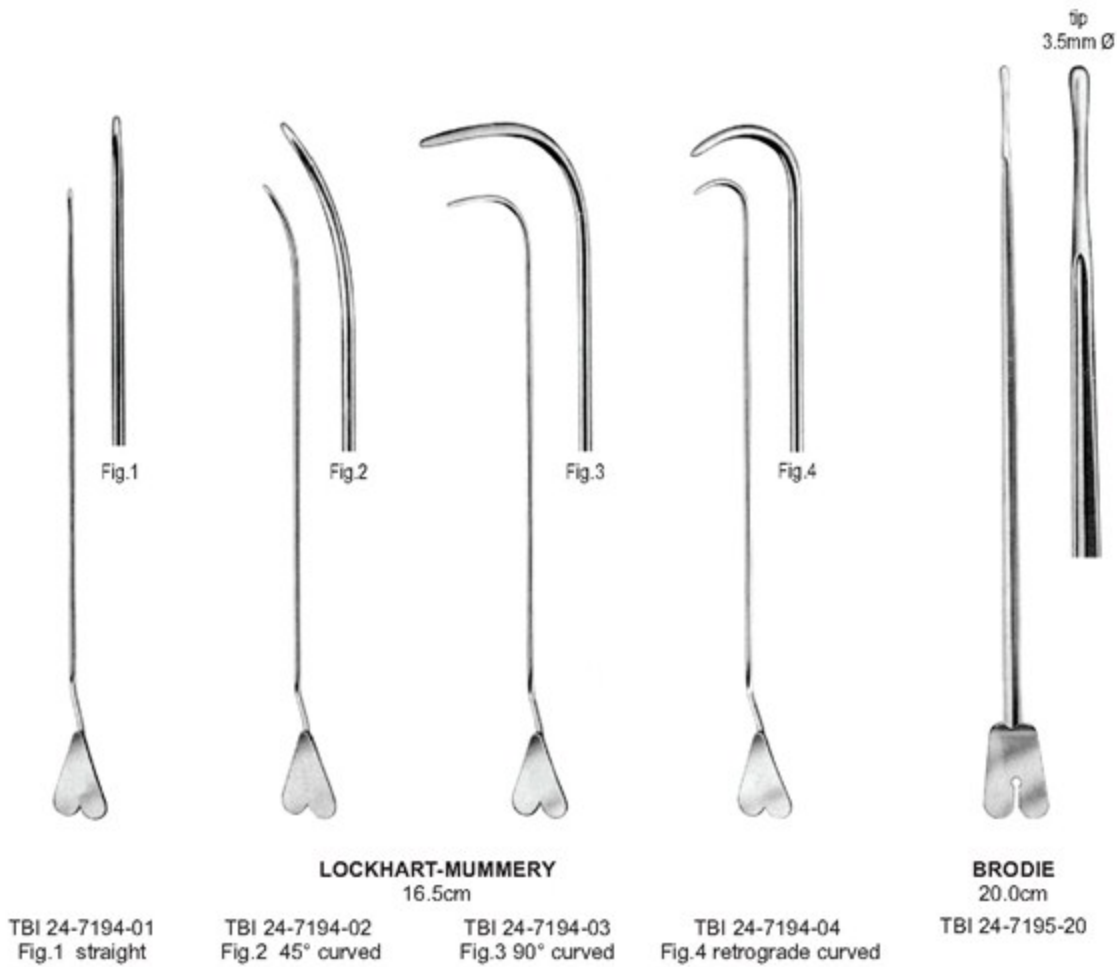

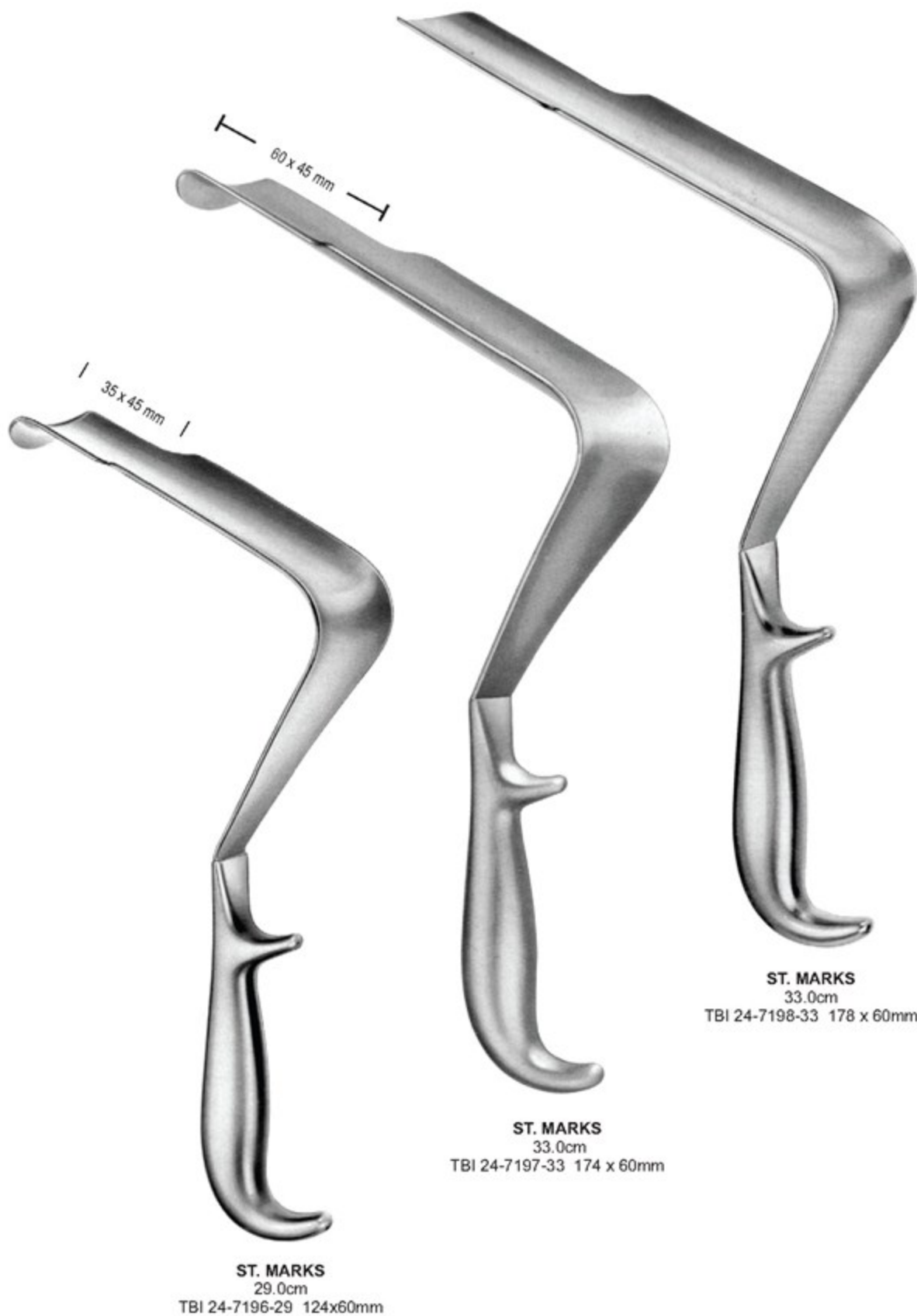

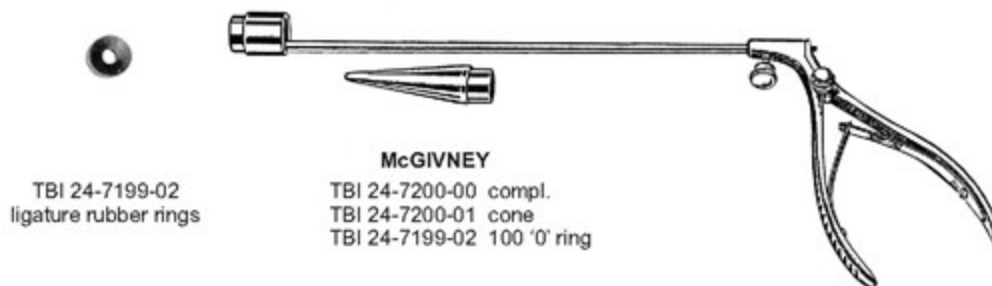

TBI 24-7199-02
ligature rubber rings

McGIVNEY
 TBI 24-7200-00 compl.
 TBI 24-7200-01 cone
 TBI 24-7199-02 100 '0' ring

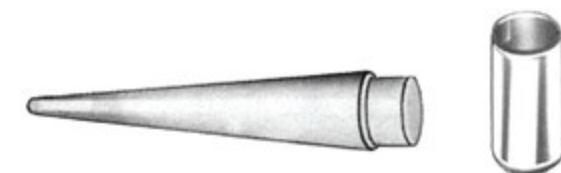

Loading Cone only — TBI 24-7201-01
 Suction Head — TBI 24-7201-11 10x11mm
 TBI 24-7201-16 10x16mm

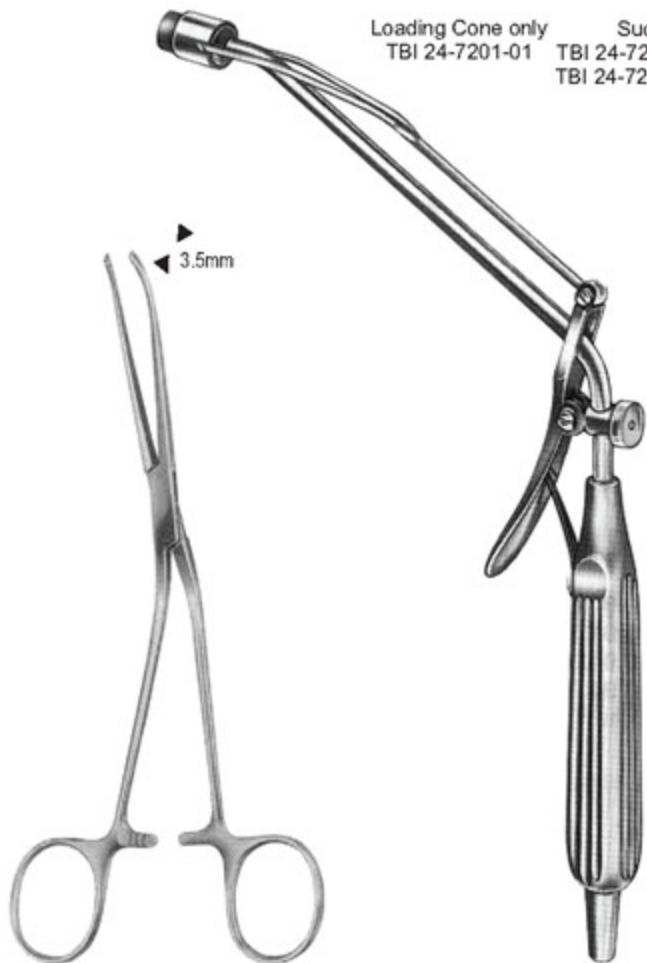

McGIVNEY
 TBI 24-7202-18
 18.5cm



18.5cm
 TBI 24-7203-00 Set
 TBI 24-7201-01 Cone
 TBI 24-7201-11 Suction Head
 TBI 24-7201-16 Suction Head
 TBI 24-7199-02 100 '0' ring



RUDD
 TBI 24-7204-31 31.5cm
 TBI 24-7201-01 cone
 TBI 24-7199-02 100 '0' ring



- EN — Rectal Biopsy Specimen Forceps
- DE — Mastdam-Biopsiezange,
- ES — Pinza sacabocado para biopsia rectal

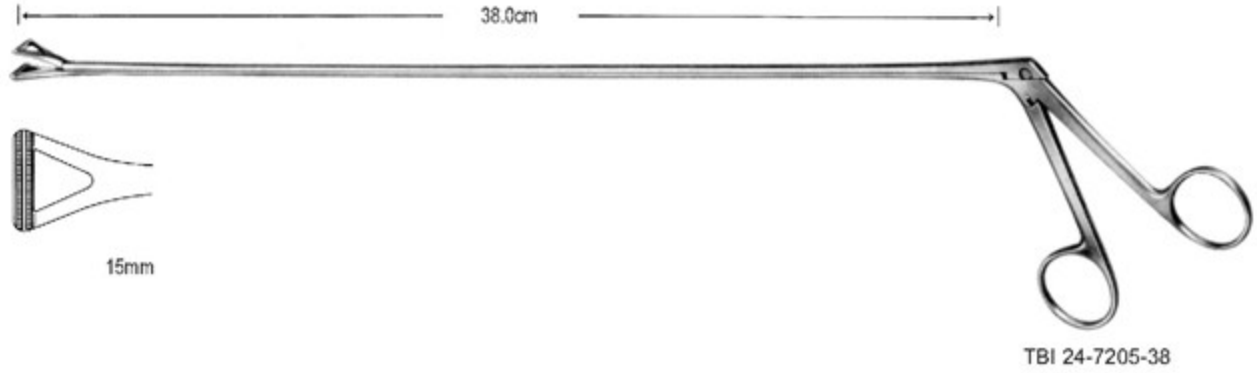

HEYWOOD-SMITH
TBI 24-7206-21
21.0cm

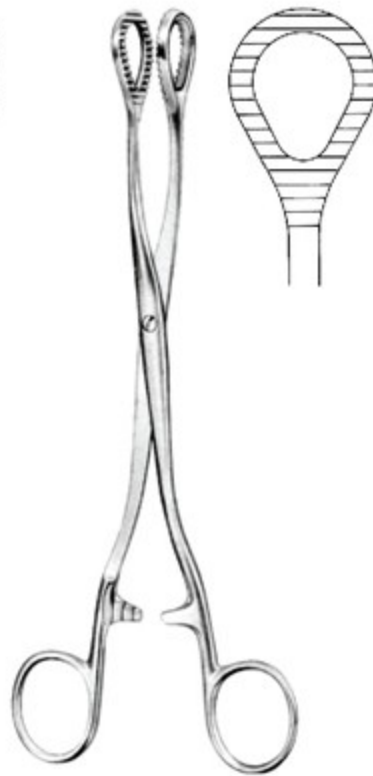

HEYWOOD-SMITH
TBI 24-7207-20
20.0cm



LUER
TBI 24-7208-24
24.5cm

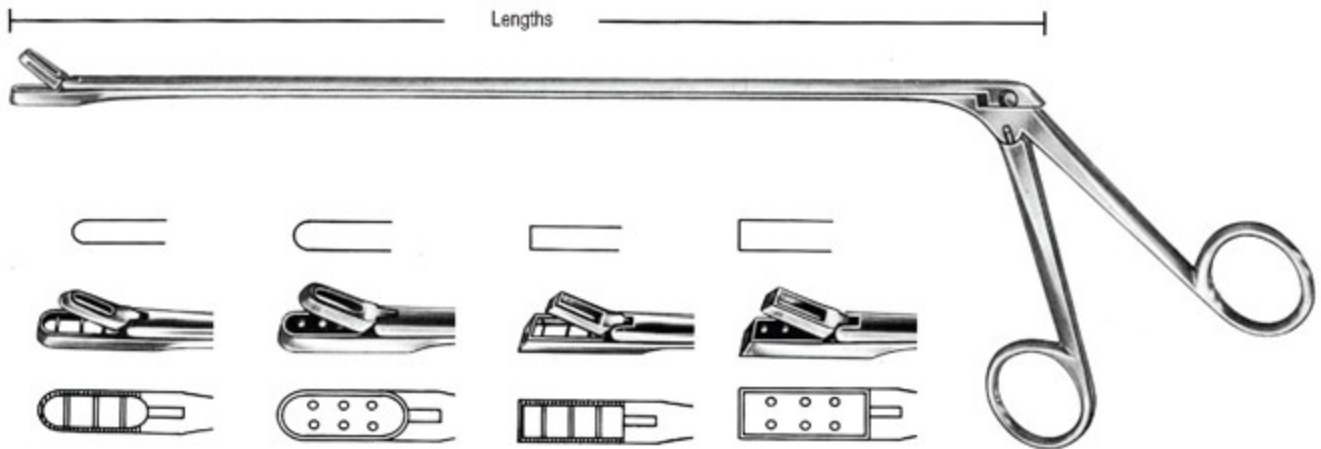
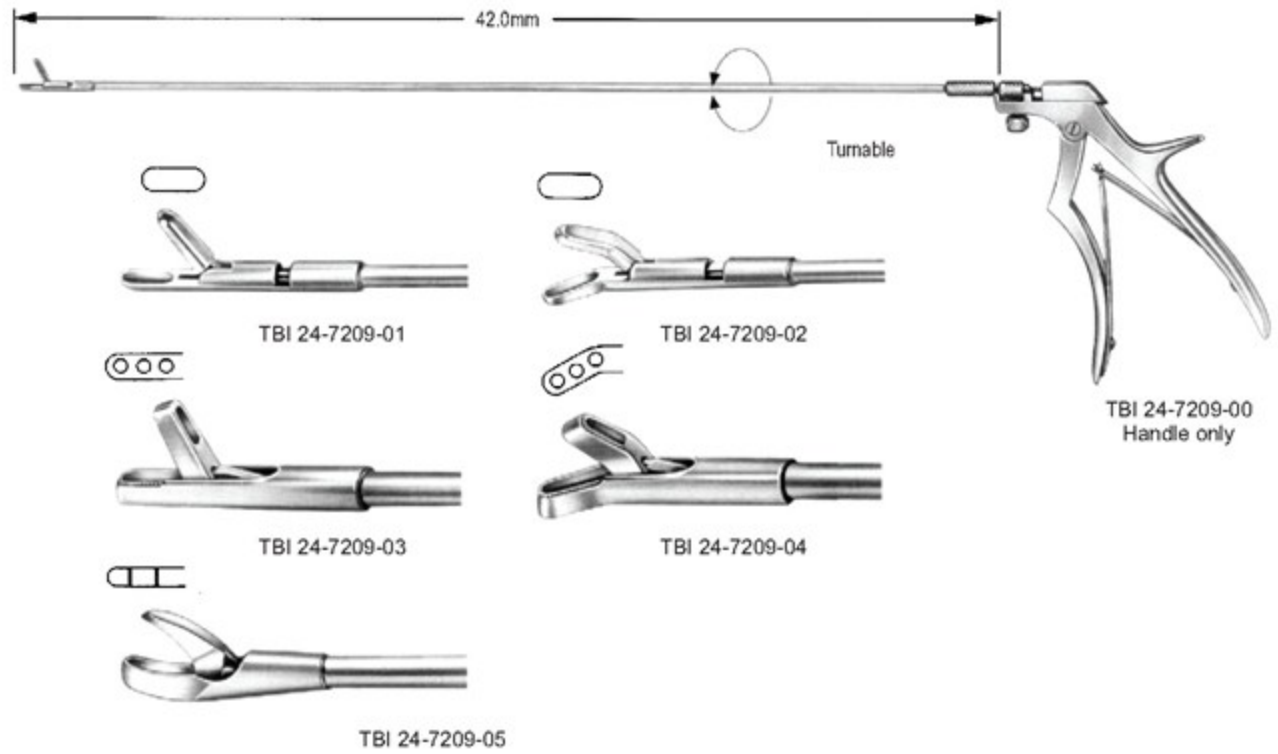

L/shaft	TBI 24-7210-28	TBI 24-7211-28	TBI 24-7212-28	TBI 24-7213-28
28.0cm	TBI 24-7210-28	TBI 24-7211-28	TBI 24-7212-28	TBI 24-7213-28
35.0cm	TBI 24-7210-35	TBI 24-7211-35	TBI 24-7212-35	TBI 24-7213-35
42.0cm	TBI 24-7210-42	TBI 24-7211-42	TBI 24-7212-42	TBI 24-7213-42



- EN — Cotton Carrier For Rectoscope, Cotton Carriers
 DE — Swattatragger Fur Rektoskope, Baumwollenboten
 ES — Posta algodón para rectoscopios, portadores de algodón

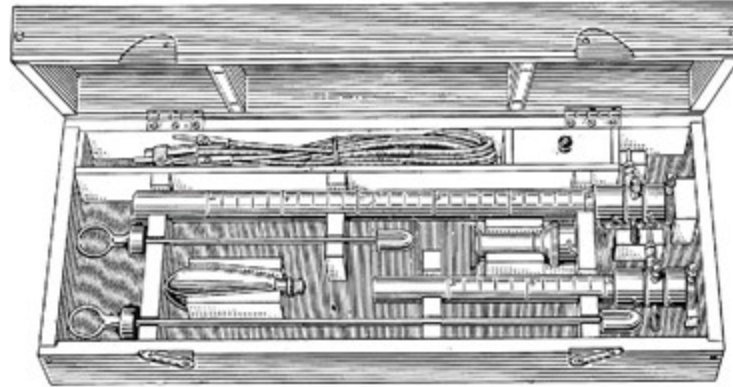

LLOYDS-DAVIES
TBI 24-7214-00 complete

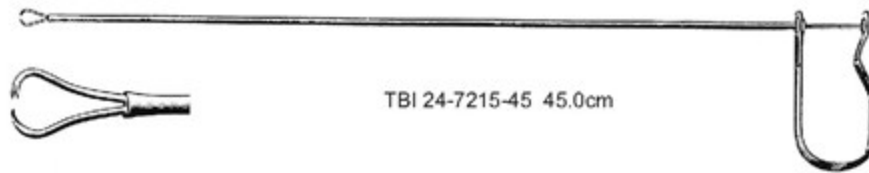

TBI 24-7215-45 45.0cm

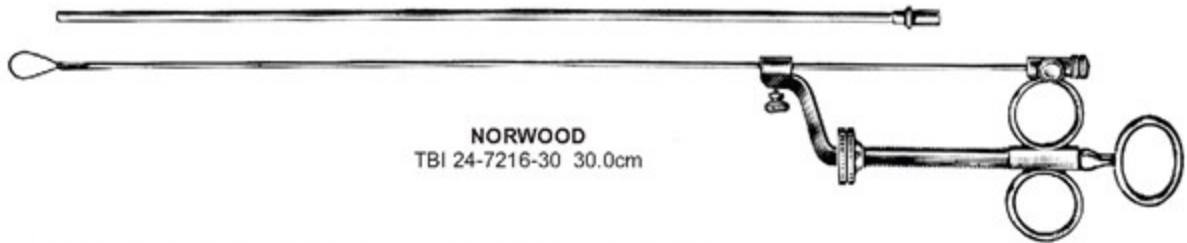

NORWOOD
TBI 24-7216-30 30.0cm

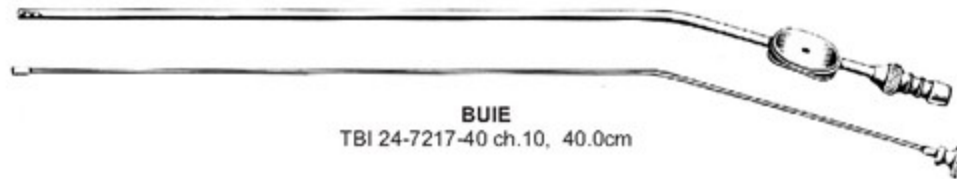

BUIE
TBI 24-7217-40 ch.10, 40.0cm

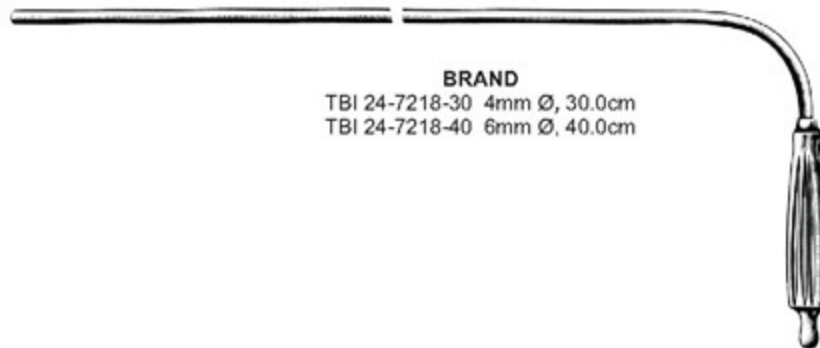

BRAND
TBI 24-7218-30 4mm Ø, 30.0cm
TBI 24-7218-40 6mm Ø, 40.0cm

EN Kidney, Liver, Gall Stone, Urology

DE Niere, Leber, Galle, Urologie

ES Riñón, Hígado, Bilis, Urología

Page 620 to 638



- EN — Kidney Pedicle Clamp Forceps
- DE — Kidney Gestielte Klammerzange
- ES — Pinzas de riñón Clamp pediculares



Guyon



TBI 25-7301-20
20 cm/8"



TBI 25-7301-22
22 cm/8¾"



TBI 25-7301-24
24 cm/9½"



TBI 25-7302-23
23 cm/9"



TBI 25-7302-24
24 cm/9½"

Atrauma



Guyon
TBI 25-7303-23
23 cm/9"



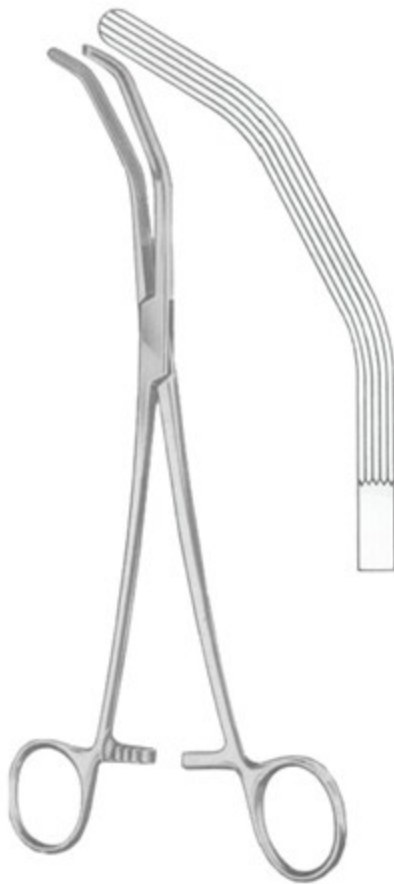

Herrick
TBI 25-7304-23
23 cm/9"



Mayo-Guyon
TBI 25-7305-23
23 cm/9"



Stille
TBI 25-7306-23
23 cm/9"





Elsasser
TBI 25-7307-20
20 cm/8"



TBI 25-7308-20
20 cm/8"



Randall



TBI 25-7309-01
19 cm/7½"



TBI 25-7309-02
19 cm/7½"



Randall

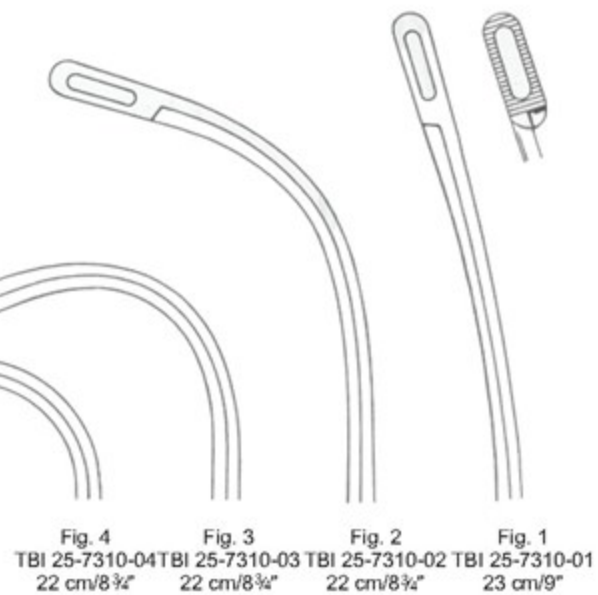

Fig. 4 TBI 25-7310-04 22 cm/8¾"
 Fig. 3 TBI 25-7310-03 22 cm/8¾"
 Fig. 2 TBI 25-7310-02 22 cm/8¾"
 Fig. 1 TBI 25-7310-01 23 cm/9"



Fig. 1
 TBI 25-7311-01
 22 cm/8 3/4"

Fig. 2
 TBI 25-7311-02
 23 cm/9"

Set of 2 pieces



Fig. 1
 TBI 25-7312-01
 22 cm/8 3/4"

Fig. 2
 TBI 25-7312-02
 23 cm/9"

Set of 2 pieces

Gall duct and
 cystic forceps



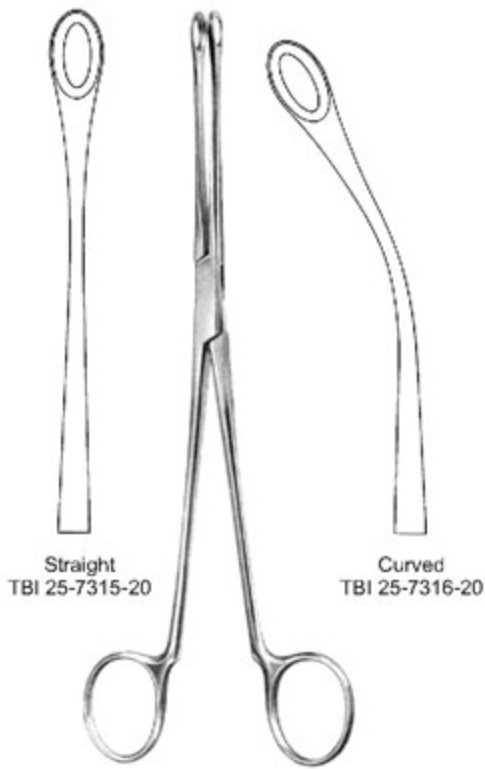

Straight
TBI 25-7315-20

Curved
TBI 25-7316-20

Blake
20 cm/8"



Straight
TBI 25-7317-20

Mayo-Blake
20 cm/8"



Curved
TBI 25-7318-20

Mayo-Blake
20 cm/8"



Czerny
TBI 25-7319-24
24.5 cm/9 3/4"



Fig. 1
TBI 25-7321-01

Fig. 2
TBI 25-7321-02

Fig. 3
TBI 25-7321-03

Fig. 4
TBI 25-7321-04

Desjardins
23 cm/9"

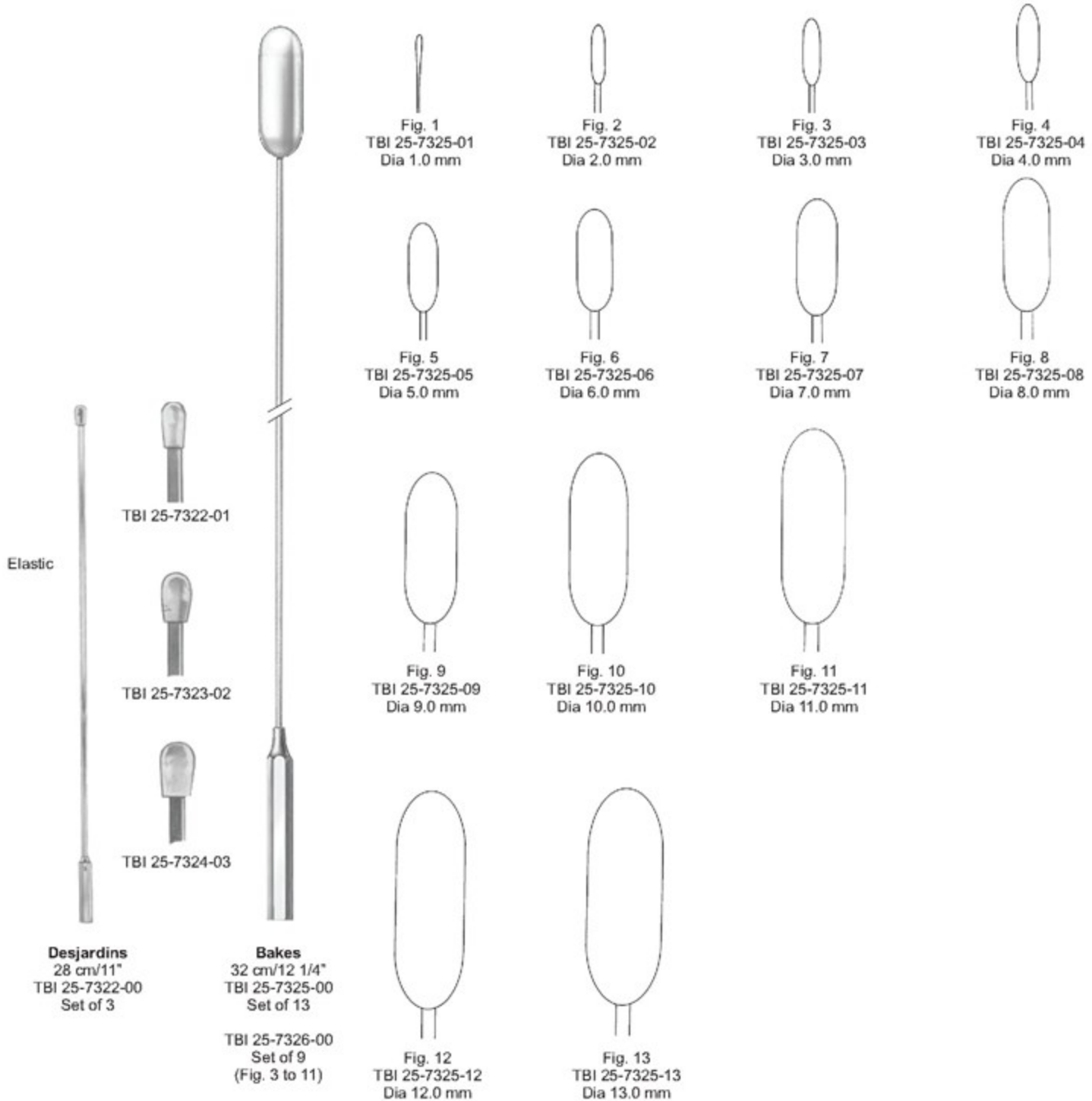

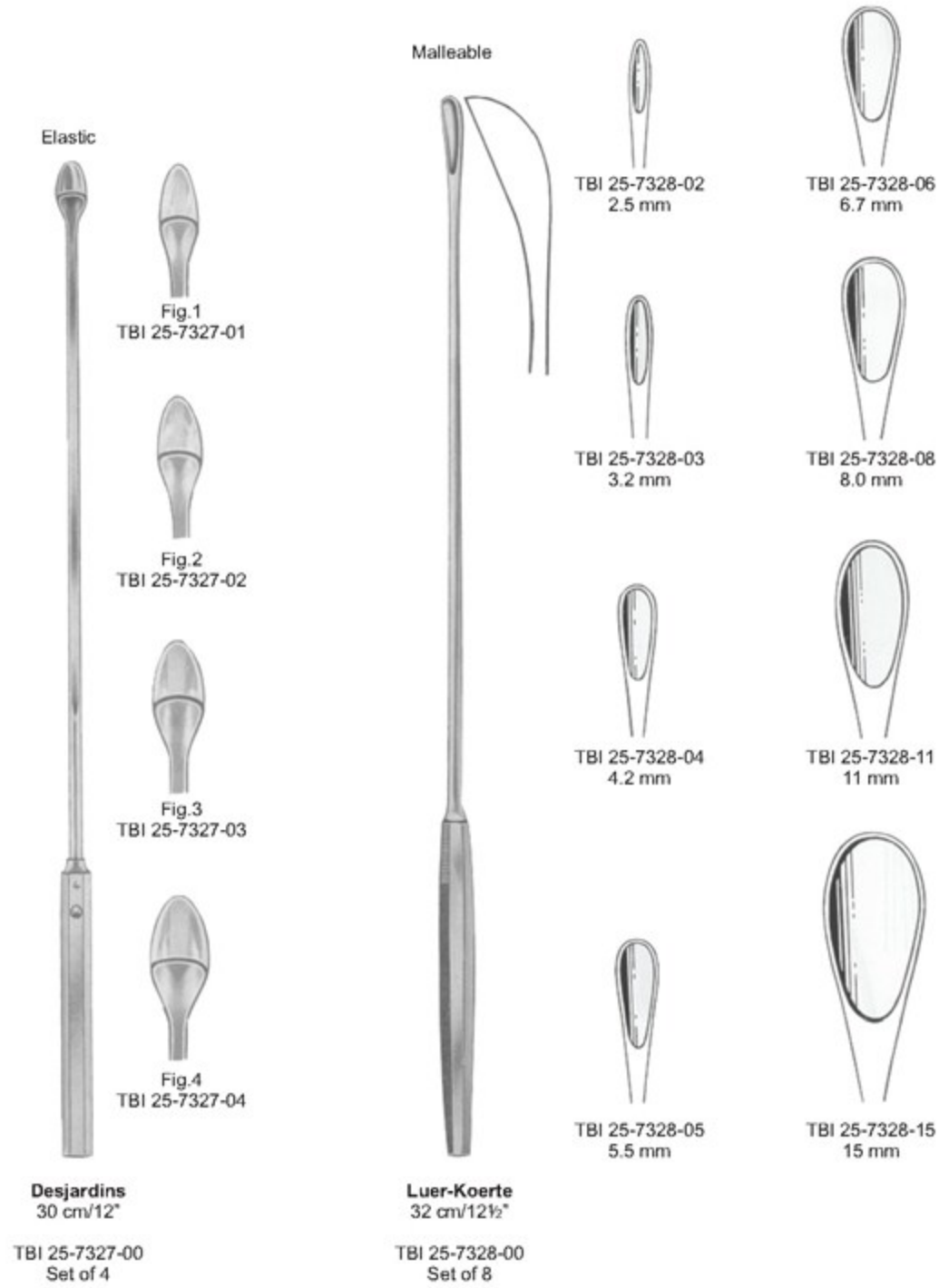

Desjardins
30 cm/12"
TBI 25-7327-00
Set of 4

Luer-Koerte
32 cm/12½"
TBI 25-7328-00
Set of 8

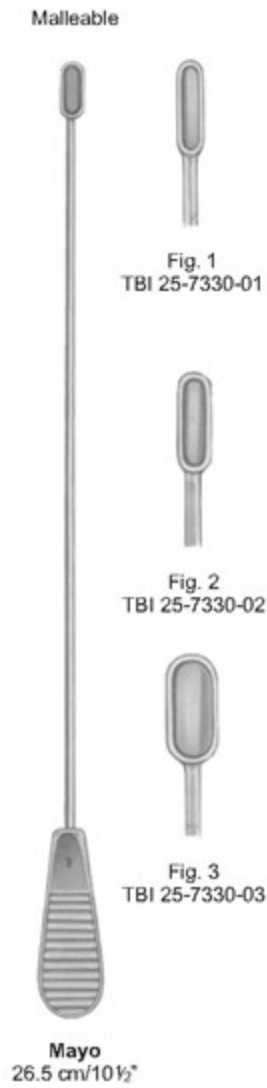



Young
TBI 25-7332-22
22 cm/8 3/4"



Young
TBI 25-7333-21
21 cm/8 1/4"



Young
TBI 25-7334-22
22 cm/8 3/4"

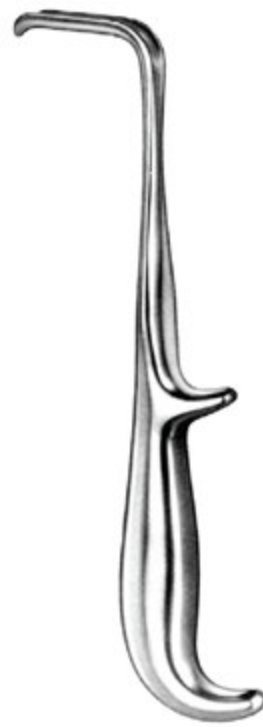

Young
TBI 25-7335-21
21 cm/8 1/4"



MILLIN
TBI 25-7336-01
24.5cm



TBI 25-7336-02 23.5cm



TBI 25-7336-03 23.0cm



TBI 25-7336-04 23.0cm



TBI 25-7336-05 24.0cm



Millin
 TBI 25-7339-00



Legueu
 TBI 25-7340-00

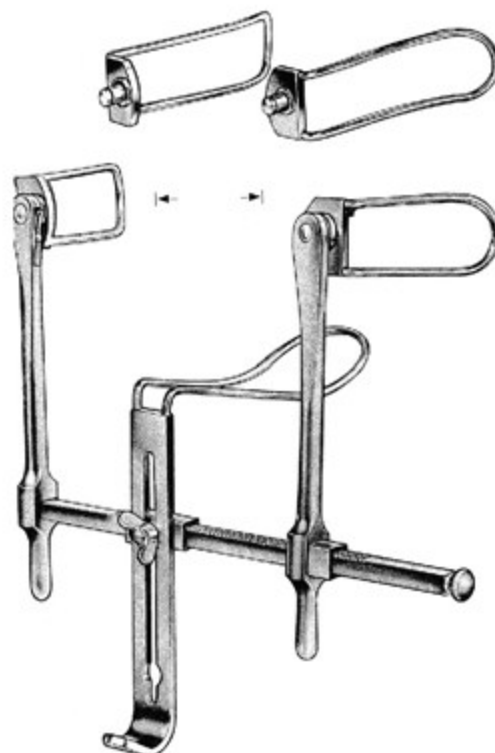

Gosset
 TBI 25-7341-00

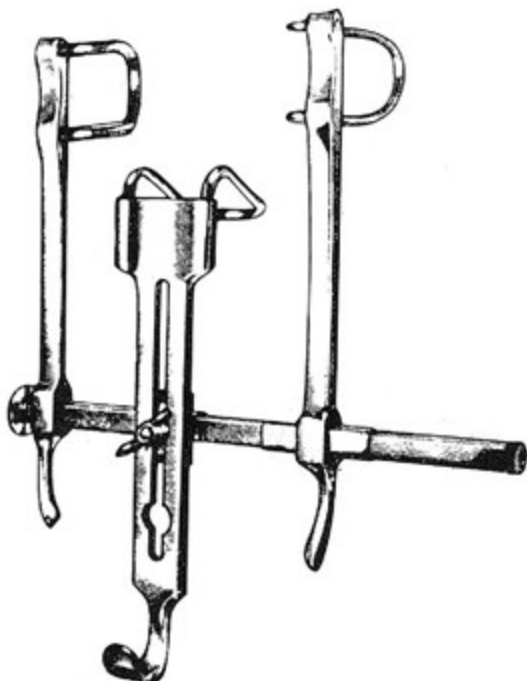

Pantings
 TBI 25-7342-00



Millin
 TBI 25-7342-01
 24 cm/9½"

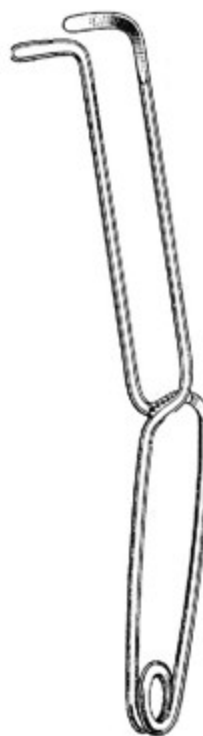

Millin
 TBI 25-7342-02
 24 cm/9½"



Millin
 TBI 25-7342-03
 24 cm/9½"



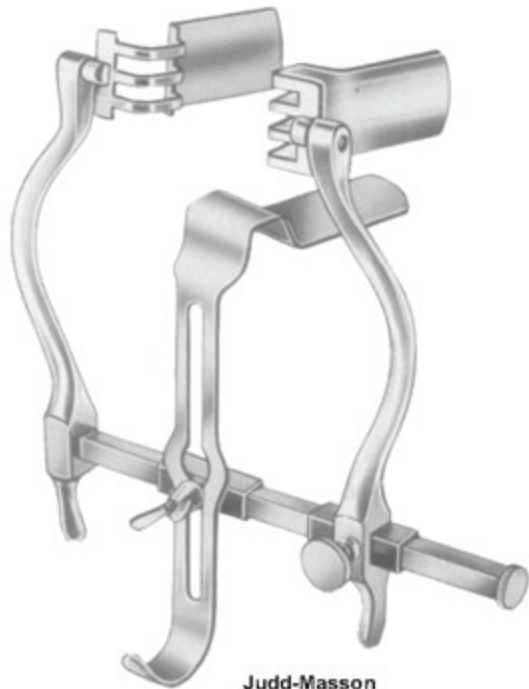

Judd-Masson
TBI 25-7343-00

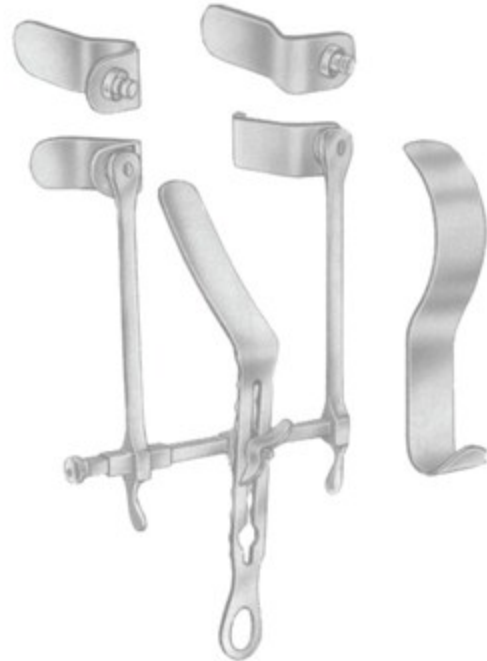

Thomson-Walker
TBI 25-7344-00



Legueu
TBI 25-7345-27
27 cm/10½"



Kocher
TBI 25-7345-26
26 cm/10¼"



Kocher
TBI 25-7346-26
26 cm/10¼"



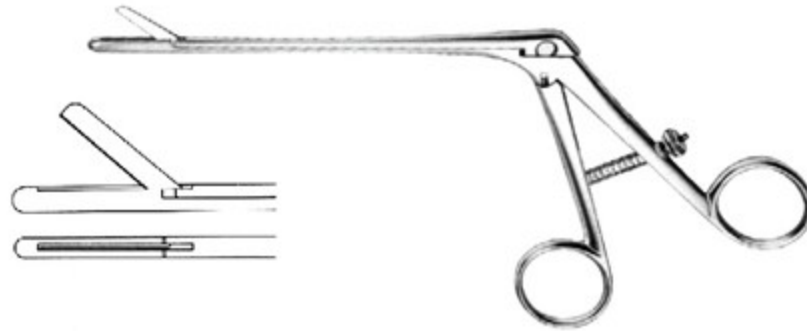

SACHSE
TBI 25-7347-12

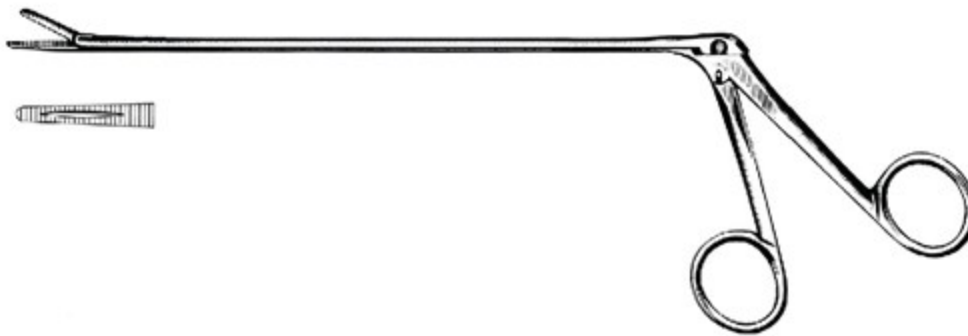

MATHIEU
TBI 25-7348-20 20.0cm
TBI 25-7348-28 28.0cm



MATHIEU
TBI 25-7349-20 20.0cm
TBI 25-7349-28 28.0cm





STOCKMANN
TBI 25-7350-08



ZIESER MEAEUS CLAMP
TBI 25-7351-10
10.0cm



STRAUSS
TBI 25-7352-11



THOMSON-WALKER
TBI 25-7353-00



LEWKOWITZ
TBI 25-7354-26
26.0cm



TBI 25-7355-26



YOUNG
TBI 25-7356-20
20.0cm



GAMCO

- TBI 25-7357-08 8mm Ø, baby size
- TBI 25-7357-11 11mm Ø, child size
- TBI 25-7357-13 13mm Ø, child size
- TBI 25-7357-16 16mm Ø, adolescent size
- TBI 25-7357-21 21mm Ø, adolescent size
- TBI 25-7357-26 26mm Ø, men's size
- TBI 25-7357-32 32mm Ø, men's size



WINKELMANN

- TBI 25-7358-12 12mm Ø
- TBI 25-7358-16 16mm Ø
- TBI 25-7358-20 20mm Ø

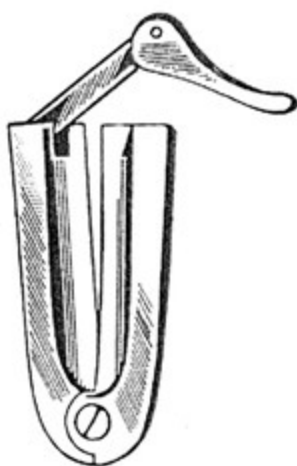

MOGEN

- TBI 25-7359-00
- 58.0162.00

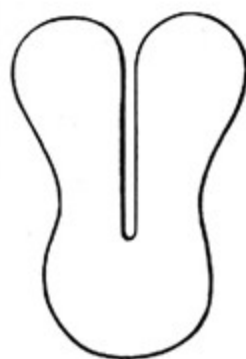

CIRCUMCISION SHIELD

- TBI 25-7360-10
- 10.0cm



CIRCUMCISION PROBE

- TBI 25-7361-15
- 15.0cm



- EN —●— Hemia Directors, Suction Tube, Cord Hook
- DE —●— Sonden, Aspirationskanulen, Haken für den Samenstrang
- ES —●— Sondas, canulas de aspiracion, gancho/el cordon



CHILD
TBI 25-7362-00



KEY
TBI 25-7363-00



TEALE
TBI 25-7364-00

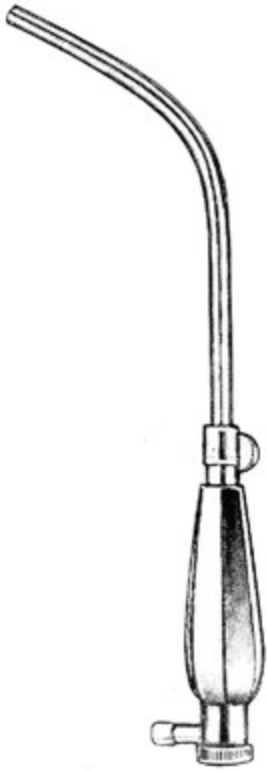

MILLIN
TBI 25-7365-00



CORD HOOK
TBI 25-7366-16
16.0cm



GUTTMANN
TBI 25-7367-26
26.0cm

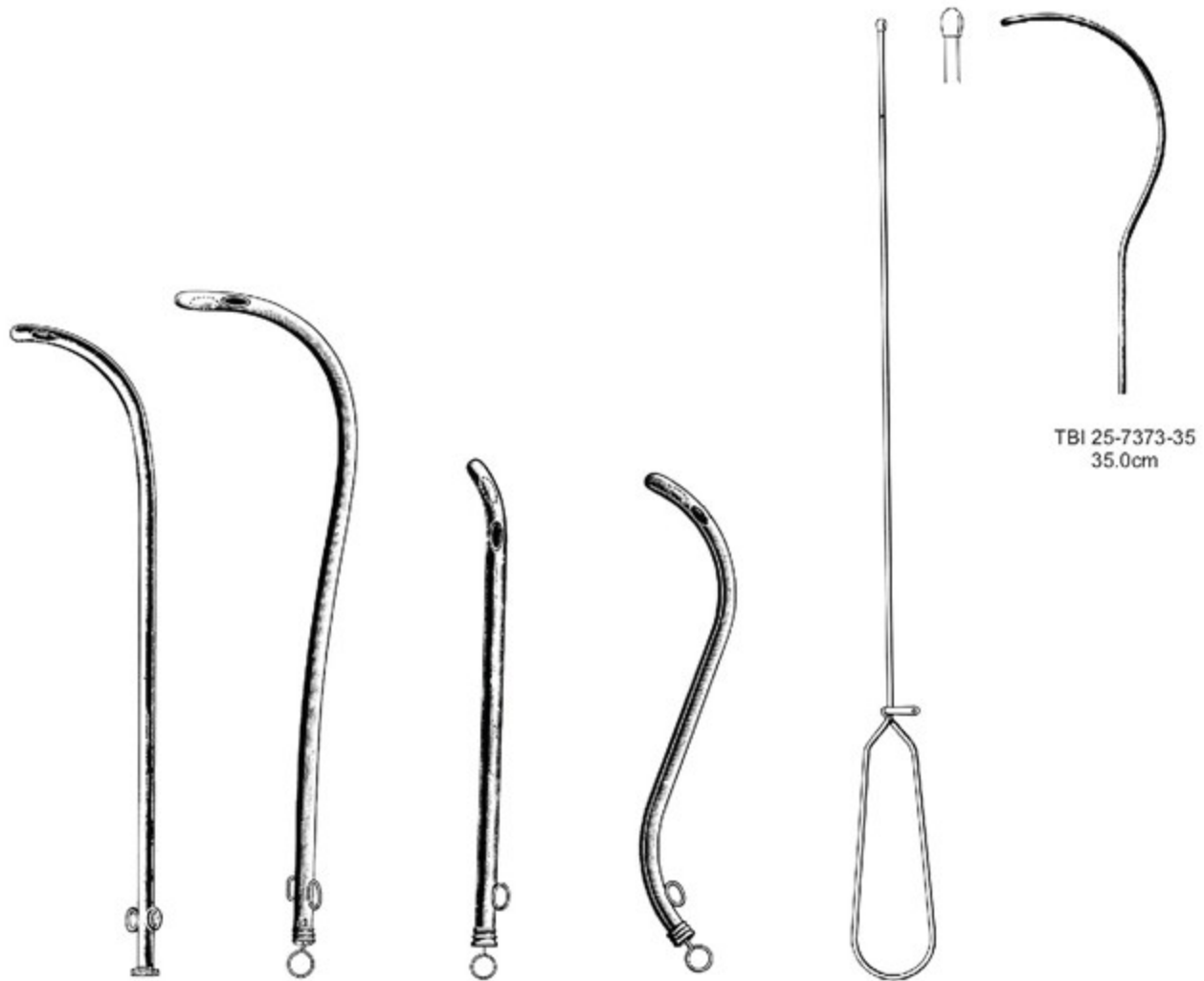

F.G.	COXETER		FEMALE 15.0cm	MALE 20.0cm
	MALE 27.0cm	28.0cm		
6	TBI 25-7368-06	TBI 25-7369-06	TBI 25-7370-06	TBI 25-7371-06
8	TBI 25-7368-08	TBI 25-7369-08	TBI 25-7370-08	TBI 25-7371-08
10	TBI 25-7368-10	TBI 25-7369-10	TBI 25-7370-10	TBI 25-7371-10
12	TBI 25-7368-12	TBI 25-7369-12	TBI 25-7370-12	TBI 25-7371-12
14	TBI 25-7368-14	TBI 25-7369-14	TBI 25-7370-14	TBI 25-7371-14
16	TBI 25-7368-16	TBI 25-7369-16	TBI 25-7370-16	TBI 25-7371-16
18	TBI 25-7368-18	TBI 25-7369-18	TBI 25-7370-18	TBI 25-7371-18
20	TBI 25-7368-20	TBI 25-7369-20	TBI 25-7370-20	TBI 25-7371-20
22	TBI 25-7368-22	TBI 25-7369-22	TBI 25-7370-22	TBI 25-7371-22
24	TBI 25-7368-24	TBI 25-7369-24	TBI 25-7370-24	TBI 25-7371-24





CLUTTON

set	TBI 25-7374-00
F.G.	
06/10	TBI 25-7374-06
08/12	TBI 25-7374-08
10/14	TBI 25-7374-10
12/16	TBI 25-7374-12
14/18	TBI 25-7374-14
16/20	TBI 25-7374-16
18/22	TBI 25-7374-18
20/24	TBI 25-7374-20
22/26	TBI 25-7374-22
24/28	TBI 25-7374-24
26/30	TBI 25-7374-26
28/32	TBI 25-7374-28

LISTER

set	TBI 25-7375-00
F.G.	
00/1	TBI 25-7375-01
0/2	TBI 25-7375-02
1/3	TBI 25-7375-03
1/4	TBI 25-7375-04
2/5	TBI 25-7375-05
3/6	TBI 25-7375-06
4/7	TBI 25-7375-07
5/8	TBI 25-7375-08
6/9	TBI 25-7375-09
7/10	TBI 25-7375-10
8/11	TBI 25-7375-11
9/12	TBI 25-7375-12
10/13	TBI 25-7375-13
11/14	TBI 25-7375-14
12/15	TBI 25-7375-15
13/16	TBI 25-7375-16
14/17	TBI 25-7375-17
15/18	TBI 25-7375-18

F.G.

06	TBI 25-7376-06
08	TBI 25-7376-08
10	TBI 25-7376-10
12	TBI 25-7376-12
14	TBI 25-7376-14
16	TBI 25-7376-16

WHEELHOUSE
TBI 25-7377-00



	VAN BUREN	GUYON	GUYON	DITTEL	DITTEL
	TBI 25-7378-00	TBI 25-7379-00	TBI 25-7380-00	TBI 25-7381-00	TBI 25-7382-00
	set No. 8-36	set No. 10-30	set No. 10-30	set No.10-30	set No.8-30
(French)					
8	TBI 25-7378-08				TBI 25-7382-08
9					TBI 25-7382-09
10	TBI 25-7378-10	TBI 25-7379-10	TBI 25-7380-10	TBI 25-7381-10	TBI 25-7382-10
11		TBI 25-7379-11	TBI 25-7380-11	TBI 25-7381-11	TBI 25-7382-11
12	TBI 25-7378-12	TBI 25-7379-12	TBI 25-7380-12	TBI 25-7381-12	TBI 25-7382-12
13		TBI 25-7379-13	TBI 25-7380-13	TBI 25-7381-13	TBI 25-7382-13
14	TBI 25-7378-14	TBI 25-7379-14	TBI 25-7380-14	TBI 25-7381-14	TBI 25-7382-14
15		TBI 25-7379-15	TBI 25-7380-15	TBI 25-7381-15	TBI 25-7382-15
16	TBI 25-7378-16	TBI 25-7379-16	TBI 25-7380-16	TBI 25-7381-16	TBI 25-7382-16
17		TBI 25-7379-17	TBI 25-7380-17	TBI 25-7381-17	TBI 25-7382-17
18	TBI 25-7378-18	TBI 25-7379-18	TBI 25-7380-18	TBI 25-7381-18	TBI 25-7382-18
19		TBI 25-7379-19	TBI 25-7380-19	TBI 25-7381-19	TBI 25-7382-19
20	TBI 25-7378-20	TBI 25-7379-20	TBI 25-7380-20	TBI 25-7381-20	TBI 25-7382-20
21		TBI 25-7379-21	TBI 25-7380-21	TBI 25-7381-21	TBI 25-7382-21
22	TBI 25-7378-22	TBI 25-7379-22	TBI 25-7380-22	TBI 25-7381-22	TBI 25-7382-22
23		TBI 25-7379-23	TBI 25-7380-23	TBI 25-7381-23	TBI 25-7382-23
24	TBI 25-7378-24	TBI 25-7379-24	TBI 25-7380-24	TBI 25-7381-24	TBI 25-7382-24
25		TBI 25-7379-25	TBI 25-7380-25	TBI 25-7381-25	TBI 25-7382-25
26	TBI 25-7378-26	TBI 25-7379-26	TBI 25-7380-26	TBI 25-7381-26	TBI 25-7382-26
27		TBI 25-7379-27	TBI 25-7380-27	TBI 25-7381-27	TBI 25-7382-27
28	TBI 25-7378-28	TBI 25-7379-28	TBI 25-7380-28	TBI 25-7381-28	TBI 25-7382-28
29		TBI 25-7379-29	TBI 25-7380-29	TBI 25-7381-29	TBI 25-7382-29
30	TBI 25-7378-30	TBI 25-7379-30	TBI 25-7380-30	TBI 25-7381-30	TBI 25-7382-30
31	TBI 25-7378-31				
32	TBI 25-7378-32				
33	TBI 25-7378-33				
34	TBI 25-7378-34				
35	TBI 25-7378-35				
36	TBI 25-7378-36				



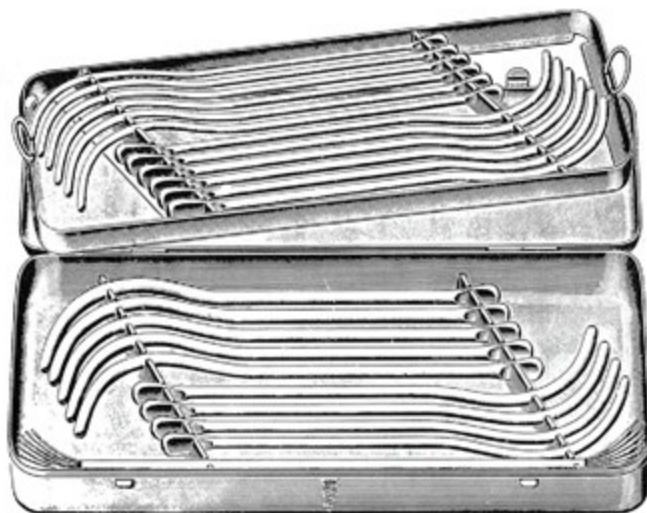

VAN BUREN
 TBI 25-7383-00
 420x175x40 mm
 set in metal case containing
 21 bougies



GUYON
 TBI 25-7384-00
 420x175x40mm
 set in metal case containing
 21 bougies
 6 liliform in metal tube

- EN** Dermatology
- DE** Dermatologie
- ES** Dermatología

Page 639 to 640

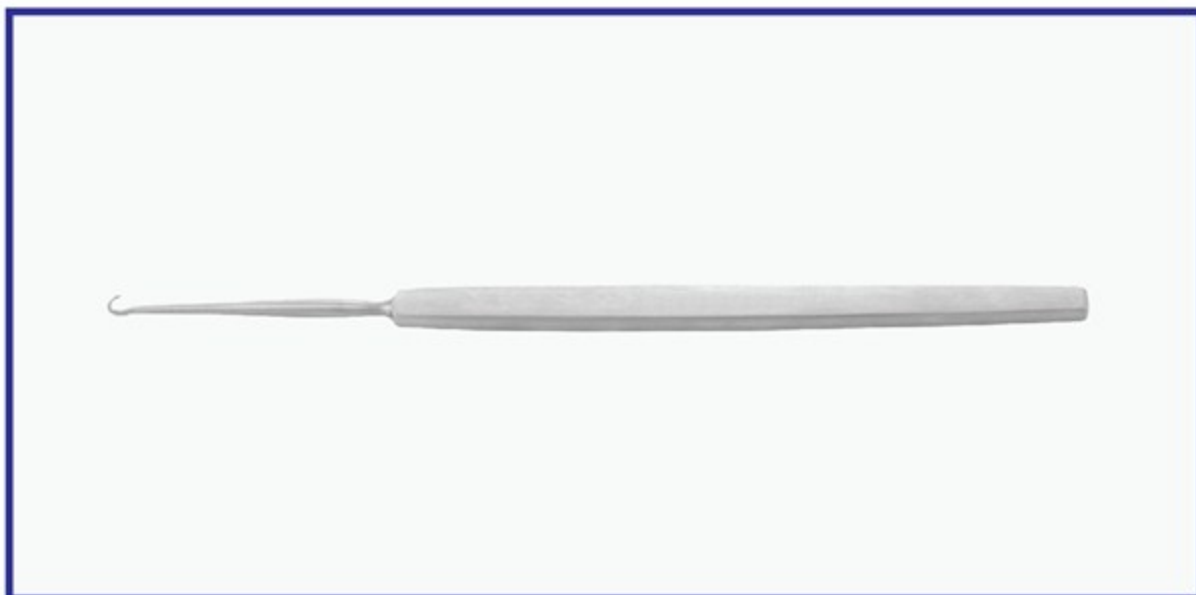



Comedone Extractors

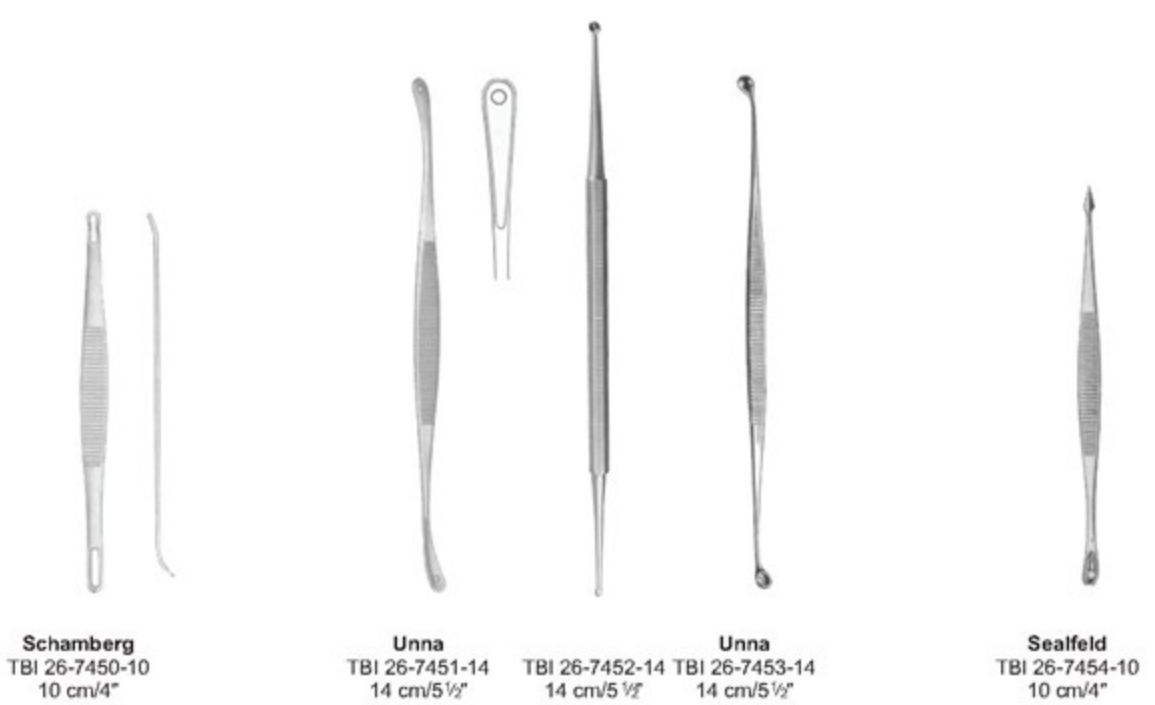

Schamberg
TBI 26-7450-10
10 cm/4"

Unna
TBI 26-7451-14
14 cm/5½"

TBI 26-7452-14
14 cm/5½"

Unna
TBI 26-7453-14
14 cm/5½"

Sealfield
TBI 26-7454-10
10 cm/4"

Skin Curettes



Saalfeld
TBI 26-7455-14
14 cm/5½"

Katsch
TBI 26-7456-14
11.5 cm

Unna-Vidal
TBI 26-7457-18
18 cm/7"

Gillesberger
TBI 26-7458-14
14.5cm

Piffard
14.5cm/5¾"

Fig. 1 TBI 26-7459-01

Fig. 2 TBI 26-7459-02

Fig. 3 TBI 26-7459-03

Lupus Currettes

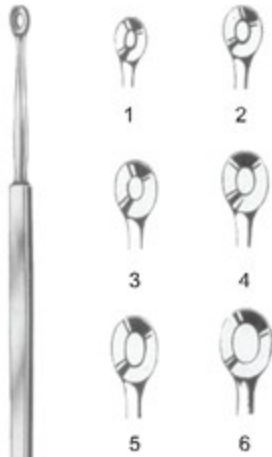

Wolff
 14 cm/5 1/2"

- Fig.
 1 TBI 26-7460-01
 2 TBI 26-7460-02
 3 TBI 26-7460-03
 4 TBI 26-7460-04
 5 TBI 26-7460-05
 6 TBI 26-7460-06

Lupus Currettes Lupus Scraper

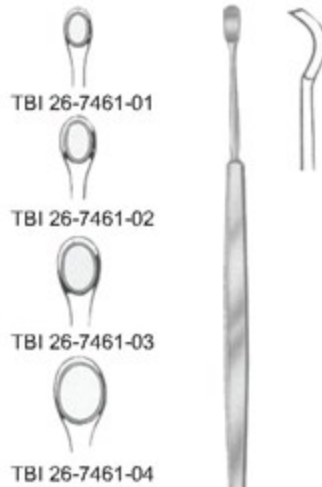

Fox
 14 cm/5 1/2"

Vidal
 TBI 26-7462-14
 14 cm/5 1/2"

Moncorps Knife



Moncorps
 TBI 26-7463-14
 14 cm/5 1/2"

Cutaneous Hook



Gillies
 Fig. 1 TBI 26-7464-01
 Fig. 2 TBI 26-7464-02
 18 cm/7"

Kilner
 TBI 26-7465-15
 15 cm/6"



KEYS
 10.0cm

- 1 ○ TBI 26-7466-02 2mm
- 2 ○ TBI 26-7466-03 3mm
- 3 ○ TBI 26-7466-04 4mm
- 4 ○ TBI 26-7466-05 5mm
- 5 ○ TBI 26-7466-06 6mm
- 6 ○ TBI 26-7466-07 7mm
- 7 ○ TBI 26-7466-08 8mm



TBI 26-7467-00
 Biopsy set for taking skin specimen
 core drills 1.5, 3.0, 4.5mm ø



TBI 26-7468-13
 13.0cm

TBI 26-7469-13
 13.0cm



EN Tracheotomy

DE Tracheotomie

ES Traqueotomía

Page 641 to 650





UCKERMANN
13.0cm



TBI 27-7501-07 7.5mm Ø
 TBI 27-7501-09 9mm Ø



TROUSSEAU
 TBI 27-7502-12 12.0cm
 TBI 27-7502-14 14.0cm



LABORDE
 TBI 27-7503-14
 14.0cm



WEERDA
 TBI 27-7504-09
 19.0cm



TBI 27-7506-01

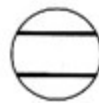

TBI 27-7506-02

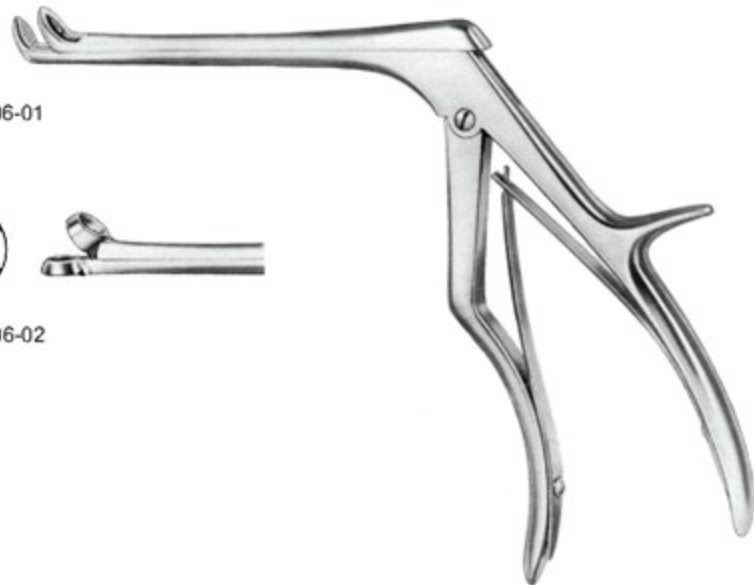

BOSE
 TBI 27-7505-07
 7.0cm



LUKENS
 TBI 27-7507-17
 17.0cm



JACKSON
 TBI 27-7508-17
 17.0cm



JACKSON
 sharp blunt
 TBI 27-7509-18 18.0cm TBI 27-7510-18



TBI 27-7511-01 sharp
 TBI 27-7511-02 blunt
 18.0cm



TBI 27-7512-01 sharp
 TBI 27-7512-02 blunt
 18.0cm



SCHOENBORN
 TBI 27-7513-21
 21.0cm





ROSE
TBI 27-7514-13
13.0cm



LUER
TBI 27-7515-11
11.0cm



JACKSON
TBI 27-7516-15
15.0cm



TBI 27-7517-15
15.0cm



ITERSON
16.0cm



TBI 27-7518-01
Sharp



TBI 27-7518-02
Blunt

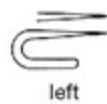

left

BOSE
TBI 27-7519-16
16.0cm



right

BOSE
TBI 27-7520-16
16.0cm

International scale

Fig.	0	1	2	3	4	5	6	7	8	9
Diameter	④	⑤	⑥	⑦	⑧	⑨	⑩	⑪	⑫	⑬mm
Length of outer tube N	45	50	55	60	65	70	75	80	85	90mm



LUER

Fig	mmØ	45-90mm	95mm	105mm
0	4			
1	5			
2	6			
3	7			
4	8			
5	9			
6	10			
7	11			
8	12			
9	13			
			TBI 27-7522-08	TBI 27-7523-08
			TBI 27-7522-09	TBI 27-7523-09
			TBI 27-7522-10	TBI 27-7523-10
			TBI 27-7522-11	TBI 27-7523-11
			TBI 27-7522-12	TBI 27-7523-12
			TBI 27-7522-13	TBI 27-7523-13



CHEVALIER-JACKSON

Fig	mmØ	45-90mm
0	4	TBI 27-7524-04
1	5	TBI 27-7524-05
2	6	TBI 27-7524-06
3	7	TBI 27-7524-07
4	8	TBI 27-7524-08
5	9	TBI 27-7524-09
6	10	TBI 27-7524-10
7	11	TBI 27-7524-11
8	12	TBI 27-7524-12
9	13	TBI 27-7524-13





KRISHABER

Fig	mm	
0	4	TBI 27-7525-04
1	5	TBI 27-7525-05
2	6	TBI 27-7525-06
3	7	TBI 27-7525-07
4	8	TBI 27-7525-08
5	9	TBI 27-7525-09
6	10	TBI 27-7525-10
7	11	TBI 27-7525-11
8	12	TBI 27-7525-12



KRISHABER-LUER

Fig	mm	
0	4	TBI 27-7526-04
1	5	TBI 27-7526-05
2	6	TBI 27-7526-06
3	7	TBI 27-7526-07
4	8	TBI 27-7526-08
5	9	TBI 27-7526-09
6	10	TBI 27-7526-10
7	11	TBI 27-7526-11
8	12	TBI 27-7526-12



PARKER

Fig	F.G	
1	16	TBI 27-7527-16
2	18	TBI 27-7527-18
3	20	TBI 27-7527-20
4	22	TBI 27-7527-22
5	24	TBI 27-7527-24
6	26	TBI 27-7527-26
7	28	TBI 27-7527-28
8	30	TBI 27-7527-30
9	32	TBI 27-7527-32



COLLIN

Fig	mm	
0	4	TBI 27-7528-04
1	5	TBI 27-7528-05
2	6	TBI 27-7528-06
3	7	TBI 27-7528-07
4	8	TBI 27-7528-08
5	9	TBI 27-7528-09
6	10	TBI 27-7528-10
7	11	TBI 27-7528-11
8	12	TBI 27-7528-12



FULLER

Fig	F.G	
1	18	TBI 27-7529-18
2	20	TBI 27-7529-20
3	22	TBI 27-7529-22
4	24	TBI 27-7529-24
5	26	TBI 27-7529-26
6	28	TBI 27-7529-28
7	30	TBI 27-7529-30
8	32	TBI 27-7529-32

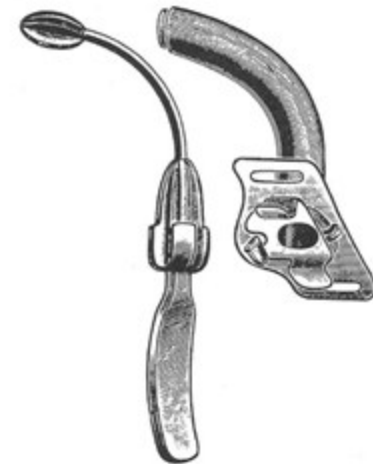

CUBLEY

Fig	F.G	
1	16	TBI 27-7530-16
2	18	TBI 27-7530-18
3	20	TBI 27-7530-20
4	22	TBI 27-7530-22
5	24	TBI 27-7530-24
6	26	TBI 27-7530-26
7	28	TBI 27-7530-28
8	30	TBI 27-7530-30
9	32	TBI 27-7530-32

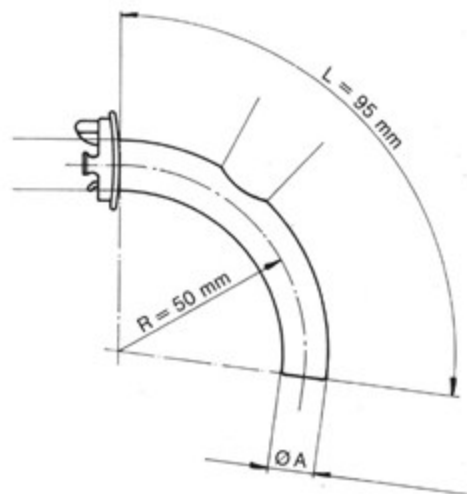
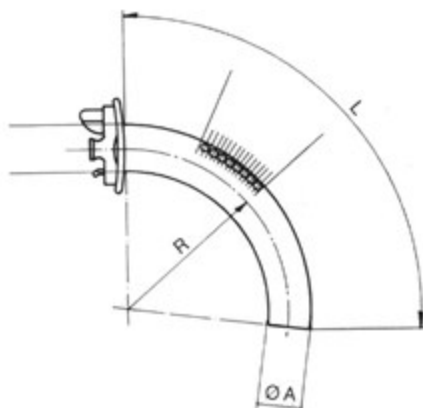

Fig		ØA	L	R
0	TBI 27-7531-08	8	65	36.5
1	TBI 27-7531-09	9	70	29
2	TBI 27-7531-10	10	75	40.5
3	TBI 27-7531-11	11	80	41.5
4	TBI 27-7531-12	12	85	43
5	TBI 27-7531-13	13	90	47.5

Fig		ØA	L	R
0	TBI 27-7532-08	8	95	50
1	TBI 27-7532-09	9	95	50
2	TBI 27-7532-10	10	95	50
3	TBI 27-7532-11	11	95	50
4	TBI 27-7532-12	12	95	50
5	TBI 27-7532-13	13	95	50



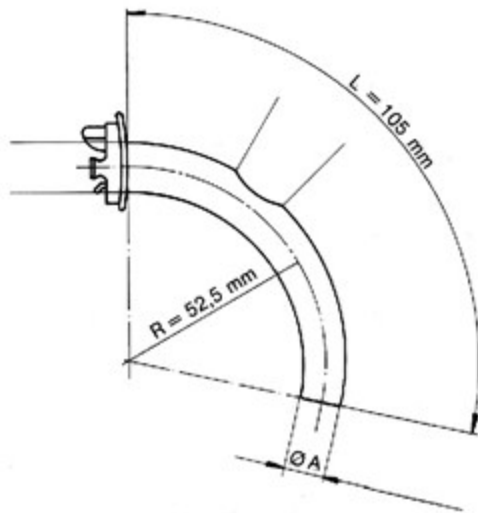
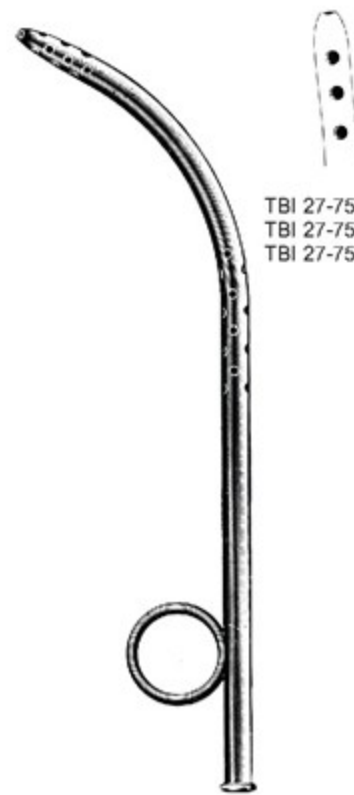

Fig		ØA	L	R
0	TBI 27-7533-08	8	105	52.5
1	TBI 27-7533-09	9	105	52.5
2	TBI 27-7533-10	10	105	52.5
3	TBI 27-7533-11	11	105	52.5
4	TBI 27-7533-12	12	105	52.5
5	TBI 27-7533-13	13	105	52.5

12mm Ø



TBI 27-7534-26
26.0cm



WAGENER-MOSHER
20.0cm

- TBI 27-7535-05 5mm Ø
- TBI 27-7535-07 7mm Ø
- TBI 27-7535-09 9mm Ø

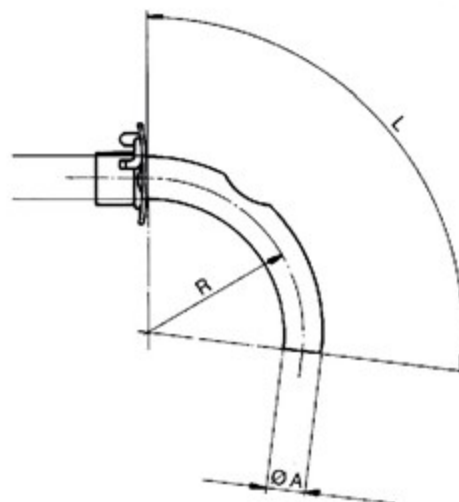

KOENIG

Fig	mmØ	50-80mm
1	5	TBI 27-7536-05
2	6	TBI 27-7536-06
3	7	TBI 27-7536-07
4	8	TBI 27-7536-08
5	9	TBI 27-7536-09
6	10	TBI 27-7536-10
7	11	TBI 27-7536-11

Fig	ØA	L	R	
0	TBI 27-7537-08	8	65	36.5
1	TBI 27-7537-09	9	70	39
2	TBI 27-7537-10	10	75	40.5
3	TBI 27-7537-11	11	80	41.5
4	TBI 27-7537-12	12	85	43
5	TBI 27-7537-13	13	90	47.5



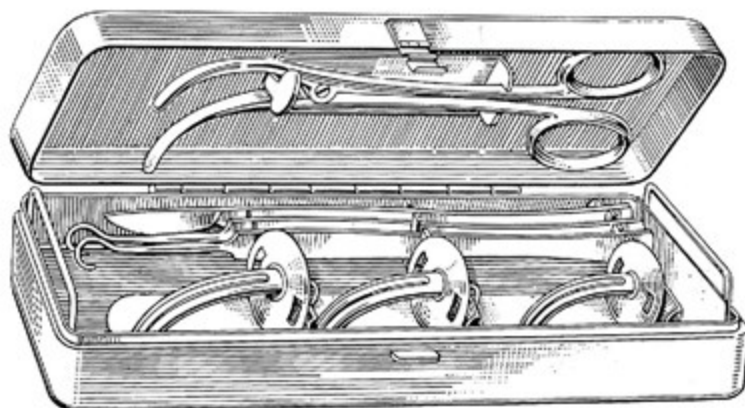

TBI 27-7538-00

TRACHEOTOMY SET

TBI 27-7538-00

complete in stainless steel case comprising:

- Fuller tracheotomy tube, 18
- Fuller tracheotomy tube, 22
- Fuller tracheotomy tube, 26
- Tracheal hook, sharp
- Tracheal hook, blunt
- Scalpel, stainless, 3cm
- Trousseau, tracheal, dilating forcep

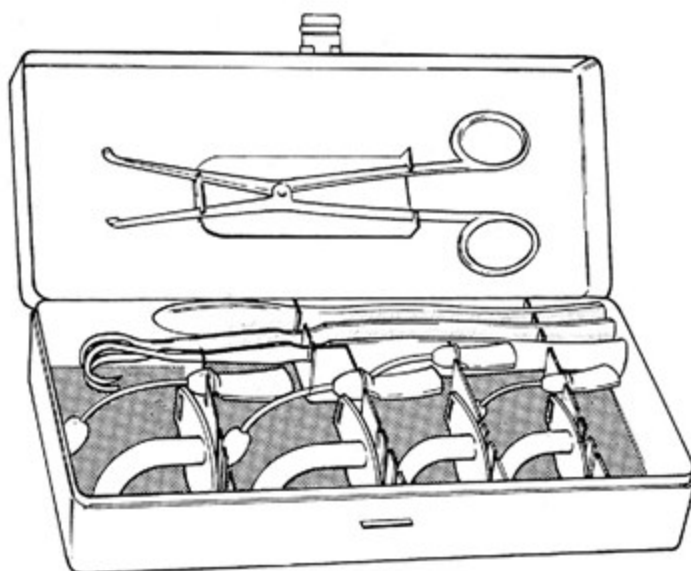

TBI 27-7539-00

TRACHEOTOMY SET

TBI 27-7539-00

complete in stainless steel case comprising:

- Parker tracheotomy tube, 18
- Parker tracheotomy tube, 22
- Parker tracheotomy tube, 24
- Parker tracheotomy tube, 26
- Tracheal hook, sharp.
- Tracheal hook, double blunt.
- Scalpel, stainless, 3cm
- Trousseau, tracheal, dilating forcep

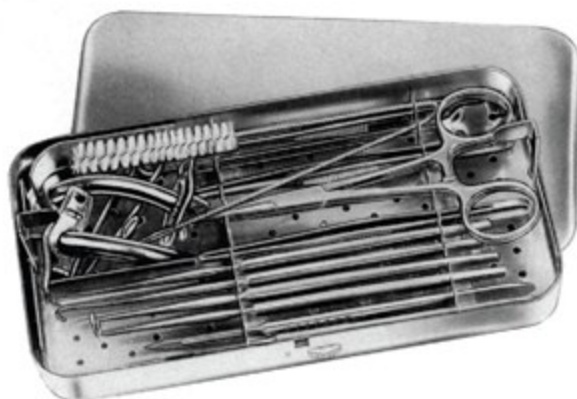

TBI 27-7540-00
 200 x 105 x 30mm

TRACHEOTOMY SET

TBI 27-7540-00
 complete in metal case, consisting of:

- 1 Handle with 1 blade, Fig. 20
- 1 Handle with 1 blade, Fig. 23
- 1 Thumb forceps, 13.0cm
- 1 Tissue forcep, 13.0cm 1 x 2 teeth
- 2 Pean Artery Forceps, 13.0cm
- 1 Grooved Director, 14.0cm
- 1 Trachea Dilator
- 2 Iterson Trachea Retractors, blunt
- 1 Bose Trachea Retractor, sharp left hand side
- 1 ditto, right hand side
- 1 Luer Trachea Tube, Standard
- 1 ditto
- 1 Cleaning Brush

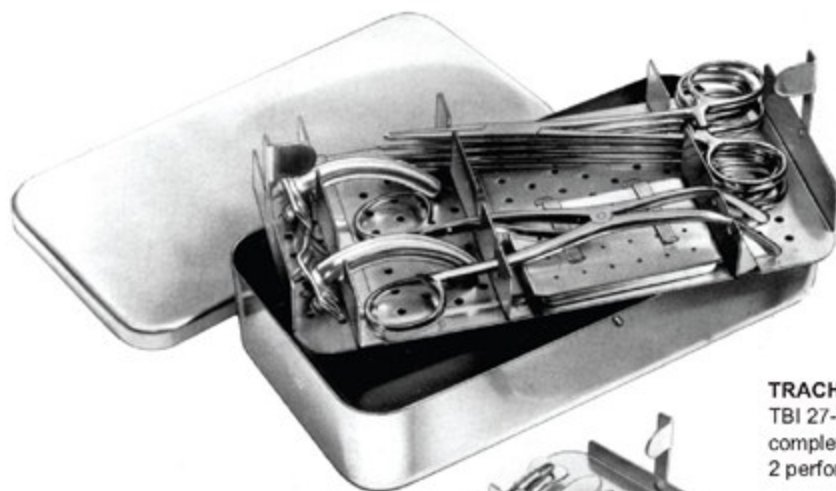

TBI 27-7541-00
 200 x 100 x 40mm

TRACHEOTOMY SET

TBI 27-7541-00
 complete in metal case 200 x 100 x 40 mm, with
 2 perforated trays of 18/8 s/s containing the following instruments:

- 1 Scalpel Handle No. 4, with blade No. 20
- 1 Scalpel Handle No. 4, with blade No. 23
- 3 Scalpel Blades, assorted, in perforated small case.
- 1 Small case for above Scalpel Blades
- 1 Dressing Forceps, serrated, 13.0cm
- 2 Tissue Forceps, 1 x 2 teeth, 13.0cm
- 4 Crile Artery Forceps, straight, 14.0cm
- 1 Grooved Director, 14.0cm
- 1 Trousseau Trachea Dilator, 14.0cm
- 2 Iterson Trachea Hooks, blunt
- 1 Bose Hook, sharp, left hand side, 16.0cm
- 1 ditto, right hand side, 16.0cm
- 1 Luer Trachea Tube, size 2.6mm diam.
 German Silver.
- 1 ditto, size 4.8mm diam, German Silver.
- 1 Cleaning Brush, 12mm diam. 26.0cm



- EN** Ophthalmology
- DE** Ophthalmologie
- ES** Oftalmología

Page 651 to 681

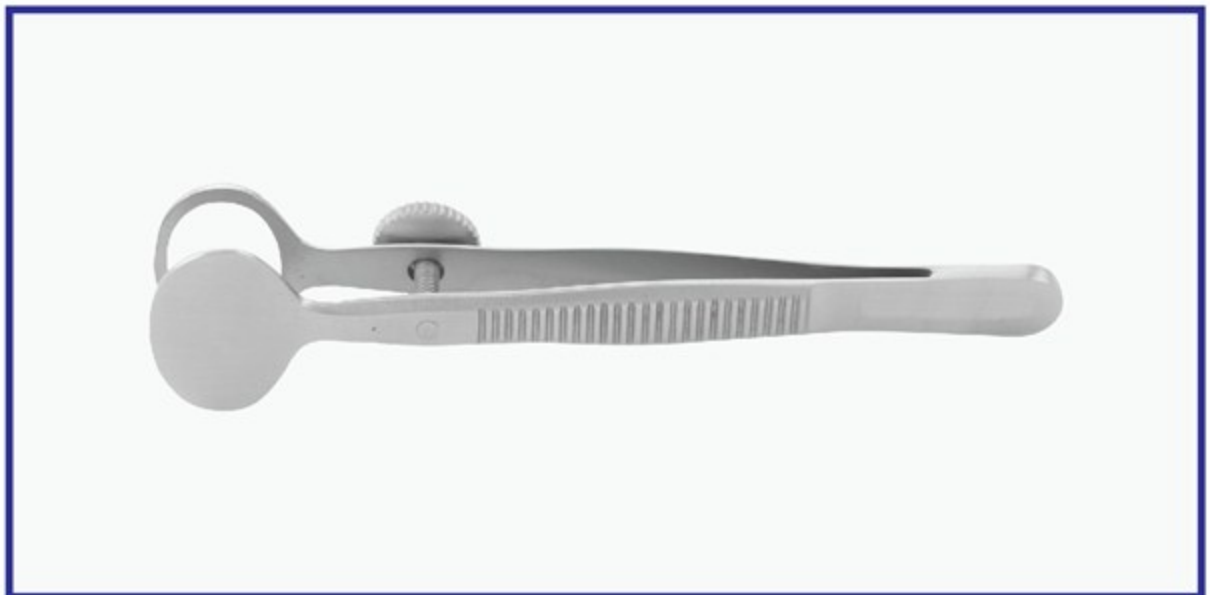



Children **Weiss** Adults
TBI 28-7601-07 TBI 28-7602-09
7 cm/2¾" 9 cm/3½"



Children **Weiss** Adults
TBI 28-7603-07 TBI 28-7604-09
7 cm/2¾" 9 cm/3½"



Park
TBI 28-7605-08
8 cm/3¼"



Park-Guyton
TBI 28-7606-08
8 cm/3¼"



Park-Maunenee
TBI 28-7607-08
8 cm/3¼"



Barraquer (Colibri)
Children Adults
TBI 28-7608-03 TBI 28-7609-04
3 cm/1¼" 4 cm/1½"



Sauer
TBI 28-7612-03
3 cm/1¼"



Barraquer
TBI 28-7610-04
4 cm/1½"



Bowman
TBI 28-7611-07
7 cm/2¾"



Goldstein
TBI 28-7613-03
3 cm/1¼"



Pley
TBI 28-7614-06
6 cm/2¼"

For left eye

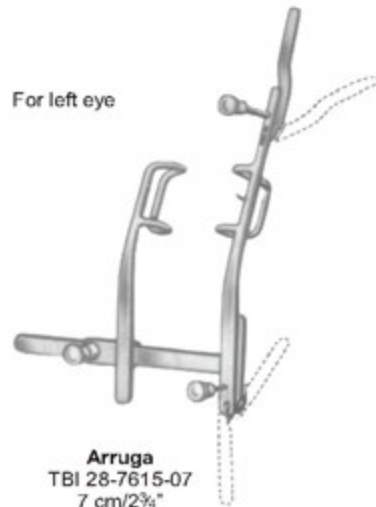

Arruga
TBI 28-7615-07
7 cm/2¾"

For right eye

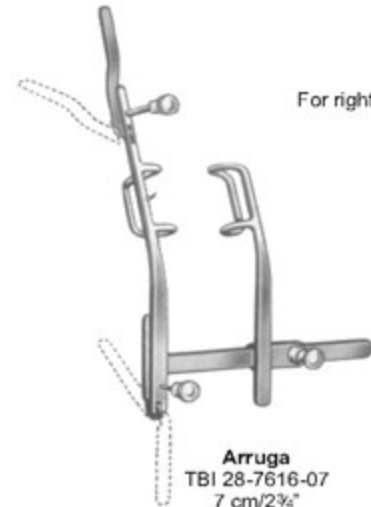

Arruga
TBI 28-7616-07
7 cm/2¾"



Mellinger-Axenfeld
 TBI 28-7617-07
 7 cm/2 3/4"



Mellinger-Axenfeld
 TBI 28-7618-07
 7 cm/2 3/4"



Mellinger
 Children TBI 28-7619-05 5 cm/2 3/4"
 Adults TBI 28-7620-07 7 cm/2 3/4"



Mellinger Beard
 Children TBI 28-7621-05 5 cm/2"
 Adults TBI 28-7622-07 7 cm/2 3/4"



Knapp Clark
 TBI 28-7623-08
 8 cm/3 1/4"



Graefe
 Children TBI 28-7624-06 6 cm/2 1/2"
 Adults TBI 28-7625-09 9 cm/3 1/2"



Lancaster
 TBI 28-7626-08
 8 cm/3 1/4"



Williams
 Children TBI 28-7627-07 7 cm/2 3/4"
 Adults TBI 28-7628-08 8 cm/3 1/4"



Lister-Burch
 TBI 28-7629-08
 8 cm/3 1/4"



Weiss
 TBI 28-7630-08
 8 cm/3 1/4"



Murdock
 TBI 28-7631-05
 5 cm/2"



Mueller
 TBI 28-7632-07
 7 cm/2 3/4"



Critchett
 TBI 28-7633-06
 6 cm/2 1/2"



Castroviejo
 TBI 28-7634-08
 8 cm/3 1/4"





Schepens
TBI 28-7635-13
13 cm/5"



Desmarres
TBI 28-7636-13
13 cm/5"



Conway
TBI 28-7637-13
13 cm/5"

8 mm



Desmarres
13 cm/5"

TBI 28-7638-12
12 mm

TBI 28-7638-14
14 mm

TBI 28-7638-16
16 mm

TBI 28-7638-18
18 mm

Lid plate



Jaeger
TBI 28-7639-11
11 cm/4 1/2"

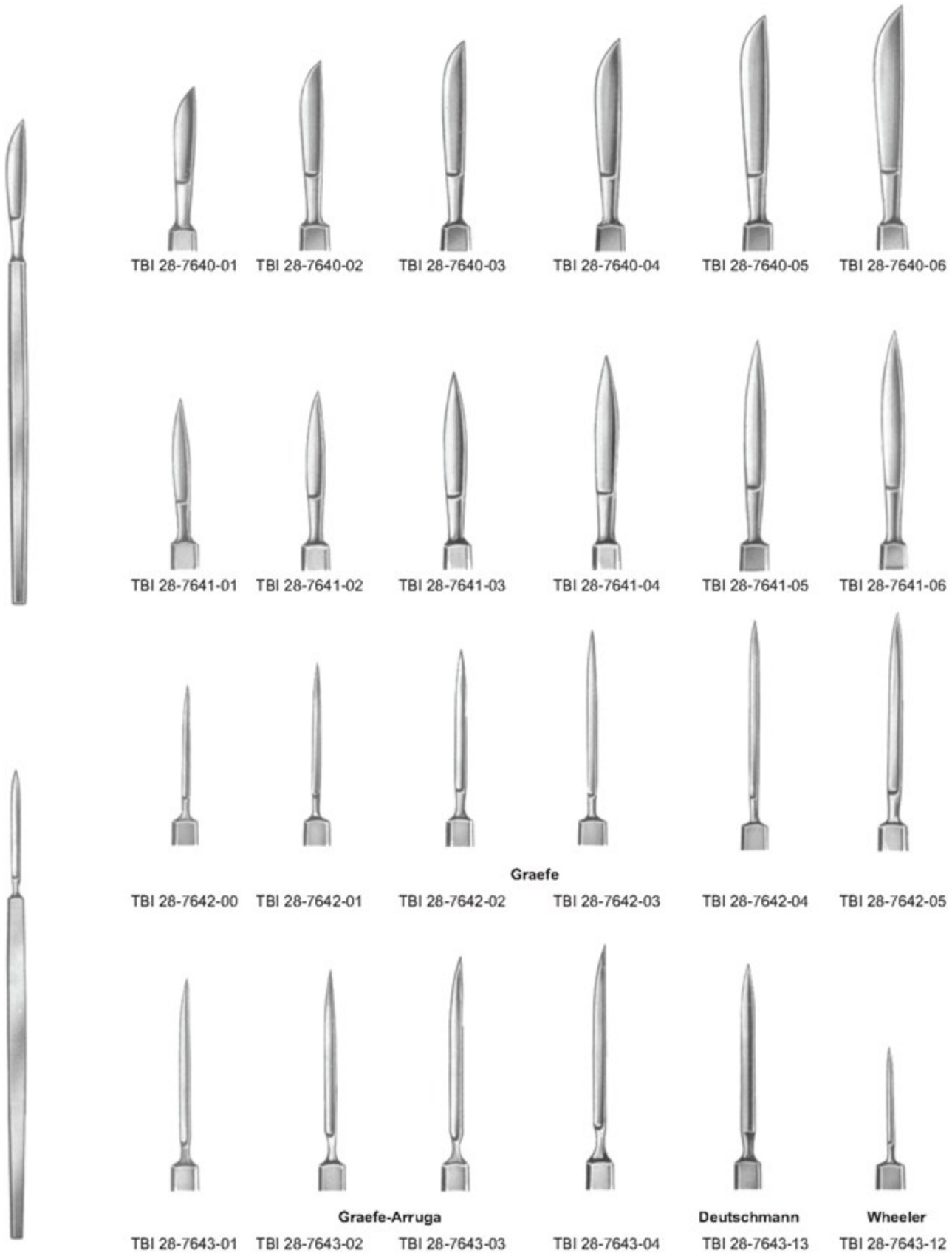



Jaeger
TBI 28-7644-01



TBI 28-7644-02



TBI 28-7644-03



TBI 28-7644-04



TBI 28-7645-01



TBI 28-7645-02



TBI 28-7645-03



TBI 28-7645-04



TBI 28-7646-01



TBI 28-7646-02



TBI 28-7646-03



TBI 28-7646-04



TBI 28-7647-01



TBI 28-7647-02



TBI 28-7647-03



TBI 28-7647-04



TBI 28-7648-01



TBI 28-7648-02



TBI 28-7648-03



TBI 28-7648-04

Jaeger-Grieshaber

Jaeger-Grieshaber





Mod. Hamburg
TBI 28-7657-12



Graefe
TBI 28-7658-13



TBI 28-7659-01



Weber
TBI 28-7659-02



TBI 28-7659-03



Bowman
TBI 28-7660-04
0.4 mm



Bowman
TBI 28-7660-05
0.5 mm



Bowman
TBI 28-7660-06
0.6 mm



Bowman
TBI 28-7660-07
0.7 mm



Bowman
TBI 28-7660-08
0.8 mm



Left **Bowman** Right
TBI 28-7661-01 TBI 28-7661-02



TBI 28-7662-01



Knapp
TBI 28-7662-02



TBI 28-7662-03



TBI 28-7663-05
5 mm



Ziegler
TBI 28-7663-06
6 mm



TBI 28-7663-07
7 mm





Guthrie
TBI 28-7681-12



Guthrie
TBI 28-7682-13



Berens
TBI 28-7683-12



Knapp Blunt
TBI 28-7684-13



Rollet Sharp
TBI 28-7685-12



Rollet
TBI 28-7686-12



Fink Blunt
TBI 28-7687-12



10.5 cm/4 1/4"

Right
TBI 28-7688-01

Left
TBI 28-7688-02



Knapp-Rollet
TBI 28-7689-02



Flexible
TBI 28-7689-03



TBI 28-7689-04



Axenfeld

Sharp
TBI 28-7690-14

Blunt
TBI 28-7691-14



Axenfeld

Sharp
TBI 28-7692-14

Blunt
TBI 28-7693-14



Paul
TBI 28-7694-12



Sautter
TBI 28-7695-01



Sautter
TBI 28-7696-02



Sautter
TBI 28-7697-03



Arruga
TBI 28-7698-13



Stevens
TBI 28-7699-14



Stevens
TBI 28-7700-12



Graefe
TBI 28-7701-01



Graefe
TBI 28-7702-02



Graefe
TBI 28-7703-03



Wecker
TBI 28-7704-13



Wecker
TBI 28-7705-13



Stock
TBI 28-7706-13



Stock
TBI 28-7707-13



Culler
TBI 28-7708-13



Suker
TBI 28-7709-14





Enucleation Scoops

Small
TBI 28-7710-16

Large
TBI 28-7710-20

Wells

Chalazion Curettes



Meyhoefer

TBI 28-7711-05 0.5 mm Ø TBI 28-7711-10 1.0 mm Ø TBI 28-7711-15 1.5 mm Ø TBI 28-7711-18 1.8 mm Ø TBI 28-7711-20 2.0 mm Ø TBI 28-7711-25 2.5 mm Ø TBI 28-7711-35 3.5 mm Ø

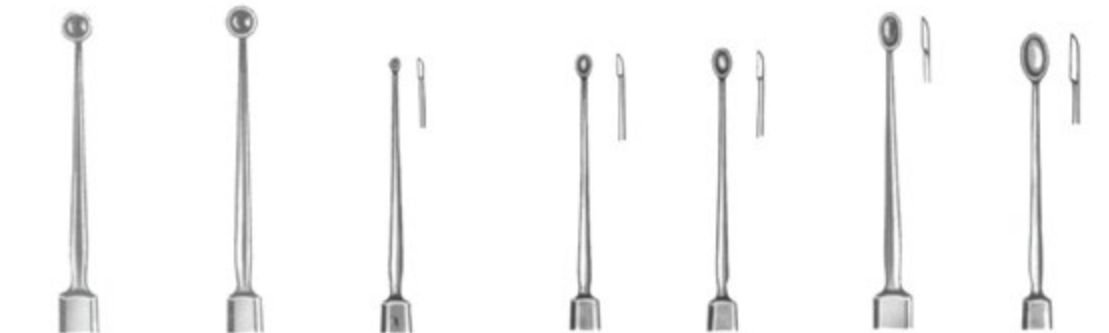

Meyhoefer TBI 28-7711-40 4.0 mm Ø Meyhoefer TBI 28-7711-45 4.5 mm Ø Hebra TBI 28-7712-10 1.0 mm Ø Hebra TBI 28-7712-20 2.0 mm Ø Hebra TBI 28-7712-25 2.5 mm Ø Hebra TBI 28-7712-30 3.0 mm Ø Hebra TBI 28-7712-35 3.5 mm Ø

Exenteration Scoops



TBI 28-7713-01



TBI 28-7713-02



Bunge
 TBI 28-7713-03



TBI 28-7713-04



TBI 28-7713-05



Chalazion Curette, Double

Axenfeld
 TBI 28-7714-13
 13 cm/5"



Lachrymal Sac Dissector

Lang
 TBI 28-7715-13
 13 cm/5"





Irrigating Cannulas

Straight



Binkhorst
TBI 28-7716-01
22 gauge

Right



Binkhorst
TBI 28-7717-02
22 gauge

Left



Binkhorst
TBI 28-7718-03
22 gauge



Bonn
TBI 28-7719-04
20 gauge



Bonn
TBI 28-7720-05
19 gauge

Probe Point



Hamburg
TBI 28-7721-06
23 gauge

Irrigation/Aspiration Cannulas



Simcoe
TBI 28-7722-01
23 gauge

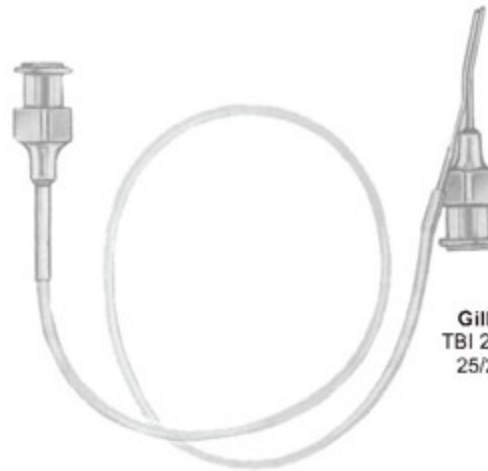

stotome Cannulas
Gills-Welsh
TBI 28-7723-02
25/23 gauge

Lens Manipulation Cannulas



Knolle-Kelmann
TBI 28-7724-01
22 gauge



Nevyas
TBI 28-7725-02
22 gauge



Kratz
TBI 28-7726-03
22 gauge



Freeman
TBI 28-7727-01
27 gauge



Irrigating Vectis Cannulas



Cortex Aspiration Cannulas



Capsule Polishing Cannulas





Castroviejo
TBI 28-7736-15



Castroviejo
TBI 28-7737-20
20 mm



Holth
TBI 28-7738-01



Haitz
TBI 28-7739-02



West
TBI 28-7740-16
16 cm/6 1/4"



West
TBI 28-7741-16
16 cm/6 1/4"



Connin-Amsler
TBI 28-7742-13
13 cm/5"



Wilder
TBI 28-7743-01



Wilder
TBI 28-7744-02



Wilder
TBI 28-7745-03



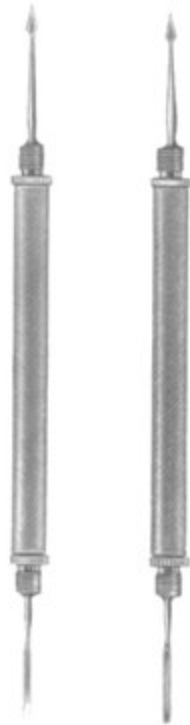

TBI 28-7746-13 TBI 28-7747-13

Needle Only
 TBI 28-7748-01

Chisel Only
 TBI 28-7748-02

Gouge Only
 TBI 28-7748-03



TBI 28-7749-13

Instrumentation for D. B. Kirby Operations



TBI 28-7750-10



Teeth
 TBI 28-7751-10 1:2 Teeth
 TBI 28-7752-10 2:3 Teeth



TBI 28-7753-10
 1 : 2



Kirby
 TBI 28-7754-10
 10 cm/4"



Kirby
 TBI 28-7755-10
 10 cm/4"



TBI 28-7756-10



TBI 28-7757-10





Tuebingen
TBI 28-7758-10
10 cm/4"



TBI 28-7759-08
8.5 cm/3 1/2"



Paufigue
TBI 28-7760-10
10 cm/4"



Barraquer
TBI 28-7761-10
10.5 cm/4 1/4"



McPherson
TBI 28-7762-10
10 cm/4"



McPherson
TBI 28-7763-07
7.5 cm/3"



McCullough
TBI 28-7764-09
9.5 cm/3 ¾"



McCullough
TBI 28-7765-09
9.5 cm/3 ¾"



Bonaccoito
TBI 28-7766-10
10 cm/4"



Bonaccoito
TBI 28-7767-10
10 cm/4"



TBI 28-7768-11
11 cm/4 ½"



11 cm/4 ½"

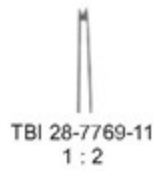

TBI 28-7769-11
1 : 2



TBI 28-7770-11
2 : 3



Nugent
10 cm/4"



TBI 28-7771-01



TBI 28-7772-02



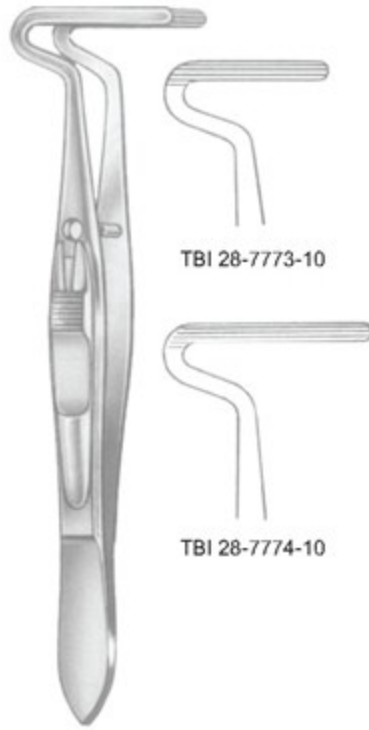

Berke
10 cm/4"

TBI 28-7773-10

TBI 28-7774-10



Blascovics
TBI 28-7775-09
9 cm/3 1/2"



Blascovics
TBI 28-7776-09
9 cm/3 1/2"



Worth
TBI 28-7777-10
10 cm/4"



Worth
TBI 28-7778-10
10 cm/4"



Jameson
TBI 28-7779-10
10 cm/4"



Jameson
TBI 28-7780-10
10 cm/4"



Prince
TBI 28-7781-10
10 cm/4"



Prince
TBI 28-7782-10
10 cm/4"



Snellen
TBI 28-7783-10
10 cm/4"



Snellen
TBI 28-7784-10
10 cm/4"



Erhardt
TBI 28-7785-09
9 cm/3 1/2"



Barraquer
TBI 28-7786-05
5.5 cm/2 1/4"



Barraquer
TBI 28-7787-05
5.5 cm/2 1/4"



Barraquer
TBI 28-7788-05
5.5 cm/2 1/4"







Graefe
 10 cm/4"



TBI 28-7796-10



TBI 28-7797-10



TBI 28-7798-10



TBI 28-7799-10



TBI 28-7800-10



TBI 28-7801-10

Conjunctival forceps



Stevens
 10.5 cm/4 1/4"



TBI 28-7802-10



TBI 28-7803-10



TBI 28-7804-10



TBI 28-7805-10



TBI 28-7806-10



TBI 28-7807-10



O'Connor
 TBI 28-7808-10
 10 cm/4"



Stevens
 TBI 28-7809-11
 11 cm/4 1/2"



Stevens
 TBI 28-7810-11
 11 cm/4 1/2"





Fischer
TBI 28-7811-07
7 cm/2 3/4"



Fischer-Arit
TBI 28-7812-07
7 cm/2 3/4"



Hess
TBI 28-7813-07
7 cm/2 3/4"



Hess
TBI 28-7814-07
7 cm/2 3/4"



Smooth **Chandler** Serrated
TBI 28-7815-017 cm/2 3/4 TBI 28-7816-02



Fuchs
TBI 28-7817-07
7 cm/2 3/4"



Gill-Hess
TBI 28-7818-07
7.5 cm/3"



Gill-Hess Teeth Below
TBI 28-7819-07
7.5 cm/3"
Teeth on side

Teeth Below
TBI 28-7820-07



Barraquer-Katzin
(Colibri)
TBI 28-7821-07
7 cm/2 3/4"



Fuchs
 TBI 28-7822-07
 7 cm/2 ¾"



Kalt
 TBI 28-7823-10
 10 cm/4"



Terson
 TBI 28-7824-09
 9.5 cm/3 ¾"



Arruga-Nizetic
 TBI 28-7825-10
 10 cm/4"



Castroviejo
 TBI 28-7826-10
 10 cm/4"



Castroviejo
 TBI 28-7827-10
 10 cm/4"



Elschnig
 TBI 28-7828-10
 10 cm/4"

For Len Implantation



Binkhorst
 TBI 28-7829-07
 7 cm/2 ¾"



Arruga
 TBI 28-7830-09
 9.5 cm/3 ¾"



Arruga
 TBI 28-7831-09
 9.5 cm/3 ¾"





Knapp
TBI 28-7832-11
11 cm/4¼"



Ayer
TBI 28-7833-09
9 cm/3½"



Ayer
TBI 28-7834-09
9 cm/3½"



Lambert
TBI 28-7835-09
9 cm/3½"



Desmarres
9 cm/3½"



TBI 28-7836-01



TBI 28-7837-02



TBI 28-7838-03



Fig. 1



Fig. 2



Fig. 3

Noyes
 Fig.1 TBI 28-7839-01
 Fig.2 TBI 28-7839-02
 Fig.3 TBI 28-7839-03
 12 cm/4 3/4"



Noyes
 TBI 28-7840-12
 12 cm/4 3/4"



Wecker
 11.5 cm/4 1/2"



TBI 28-7841-01



TBI 28-7842-02



Barraquer
 TBI 28-7843-05
 5.5 cm/2 1/4"



TBI 28-7844-09
 9 cm/3 1/2"



TBI 28-7845-09



TBI 28-7846-09



TBI 28-7847-09



TBI 28-7848-09



TBI 28-7849-09





Vannas
TBI 28-7850-08
8 cm/3 1/4"



Vannas
TBI 28-7851-08
8 cm/3 1/4"



Vannas
TBI 28-7852-08
8 cm/3 1/4"



Vannas
TBI 28-7853-08
8 cm/3 1/4"



TBI 28-7854-08
8.5 cm/3 1/4"

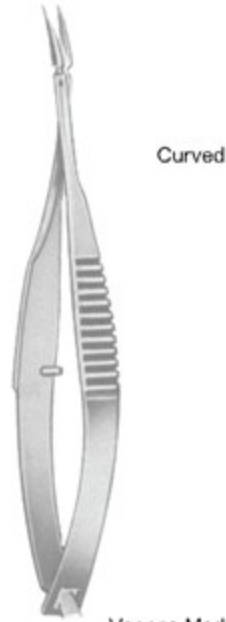

Vannas Mod. Tubingen
TBI 28-7855-08
8.5 cm/3 1/4"

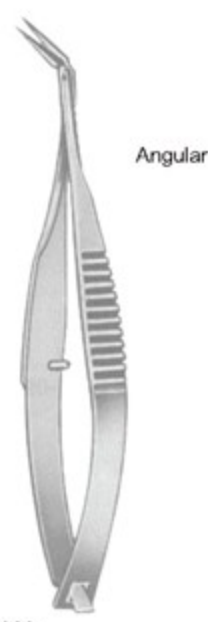

TBI 28-7856-08
8.5 cm/3 1/4"

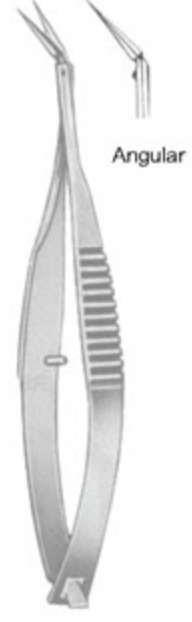

TBI 28-7857-08
8.5 cm/3 1/4"



TBI 28-7858-10
 10 cm/4"



TBI 28-7859-10
 10 cm/4"



Castroviejo
 TBI 28-7860-10
 10 cm/4"



Castroviejo
 TBI 28-7861-10
 10 cm/4"



Aebli
 TBI 28-7862-10
 10 cm/4"



Castroviejo
 TBI 28-7863-10
 10 cm/4"



Castroviejo
 TBI 28-7864-10
 10 cm/4"



Troutman-Barraquer
 TBI 28-7865-10
 10 cm/4"



Troutman-Barraquer
 TBI 28-7866-10
 10 cm/4"



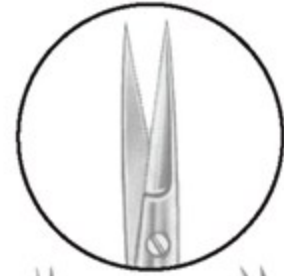

Saw Edge

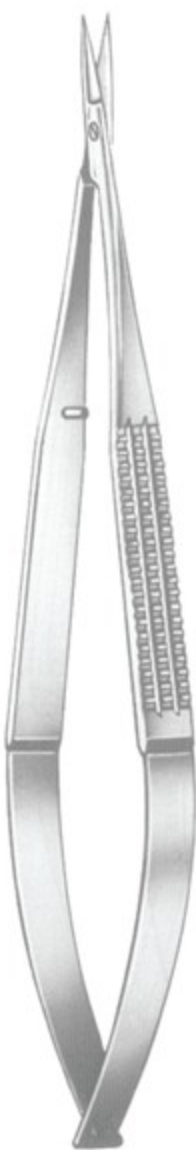

Straight
TBI 28-7867-16
16cm/6 1/4"

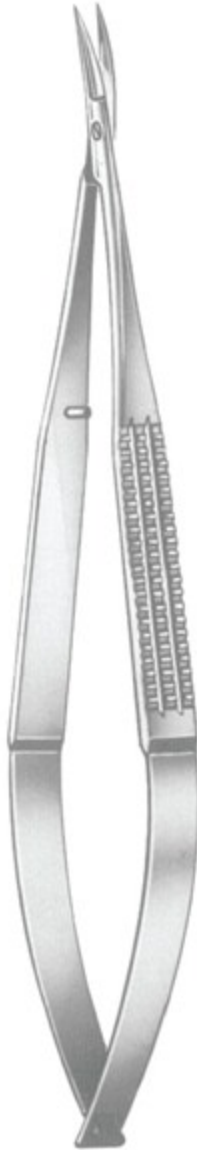

Curved
TBI 28-7868-16
16cm/6 1/4"



Straight
TBI 28-7869-16
16cm/6 1/4"



Curved
TBI 28-7870-16
16cm/6 1/4"



Millesi
Straight
TBI 28-7871-16
16cm/6 1/4"



Millesi
Curved
TBI 28-7872-16
16cm/6 1/4"



Straight
TBI 28-7873-18
18.5cm/7 1/4"



Curved
TBI 28-7874-18
18.5cm/7 1/4"



Angular
TBI 28-7875-18
18.5cm/7 1/4"



Straight
TBI 28-7876-23
23cm/9"





Straight
TBI 28-7877-14
14.5cm/5 3/4"



Curved
TBI 28-7878-14
14.5cm/5 3/4"

Dissecting Scissors



Curved
TBI 28-7879-14
14.5cm/5 3/4"

EN Gynecology

DE Gynäkologie

ES Ginecología

Page 682 to 722



**CUSCO**

TBI 29-8001-01 75 x 17mm
TBI 29-8001-02 75 x 32mm
TBI 29-8001-03 85 x 35mm
TBI 29-8001-04 100 x 37mm

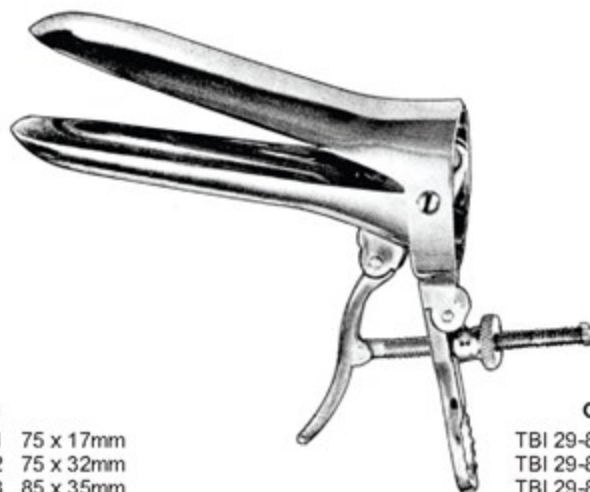
**CUSCO**

TBI 29-8002-01 75 x 17mm
TBI 29-8002-02 75 x 32mm
TBI 29-8002-03 80 x 32mm
TBI 29-8002-04 85 x 35mm
TBI 29-8002-05 110 x 35mm
TBI 29-8002-06 115 x 37mm

**CUSCO**

TBI 29-8003-01 75 x 32mm
TBI 29-8003-02 85 x 35mm
TBI 29-8003-03 100 x 35mm
TBI 29-8003-04 85 x 35mm (with cold light carrier)
TBI 29-8003-05 (cold light carrier only)

**CUSCO**

TBI 29-8004-01 75 x 17mm
TBI 29-8004-02 85 x 17mm
TBI 29-8004-03 100 x 17mm

**CUSCO (Swiss pattern)**

TBI 29-8005-01 80 x 22mm
TBI 29-8005-02 100 x 25mm
TBI 29-8005-03 105 x 27mm
TBI 29-8005-04 115 x 27mm

**CUSCO'S**

TBI 29-8006-01 (LL)
TBI 29-8006-02 (L)
TBI 29-8006-03 (M)
TBI 29-8006-04 (S)
TBI 29-8006-05 (SS)
TBI 29-8006-06 (SSS)



for children

COLLIN
 TBI 29-8007-01 55 x 10mm



COLLIN
 TBI 29-8007-02 65 x 20mm

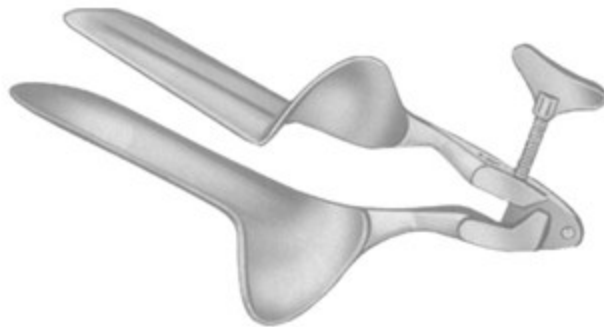

Collin-Landau
 Medium TBI 29-8007-03 35 x 100 mm



Collin
 Small TBI 29-8007-12 30 x 85 mm
 Medium TBI 29-8007-13 35 x 100 mm
 Large TBI 29-8007-14 40 x 110 mm

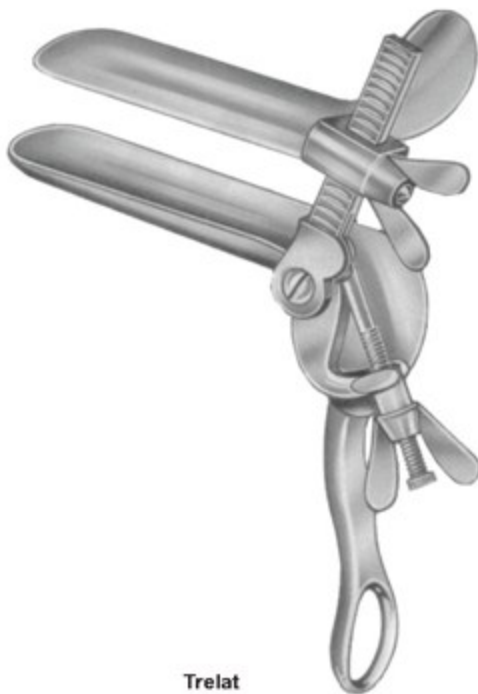

Trelat

	a	b
	mm	mm
TBI 29-8008-01	85	33
TBI 29-8008-02	95	35
TBI 29-8008-03	115	43



Grave (Standard)

	a	b
	mm	mm
TBI 29-8009-01	75	20
TBI 29-8009-02	95	35
TBI 29-8009-03	115	35
TBI 29-8009-04	125	35





Grave	a mm	b mm
TBI 29-8010-01	75	20
TBI 29-8010-02	95	35
TBI 29-8010-03	115	35
TBI 29-8010-04	130	25



Grave	a mm	b mm
Angled 135°		
TBI 29-8011-00	101	35



Fergusson	
TBI 29-8011-01	25mm Ø
TBI 29-8011-02	30mm Ø
TBI 29-8011-03	35mm Ø
TBI 29-8011-04	40mm Ø

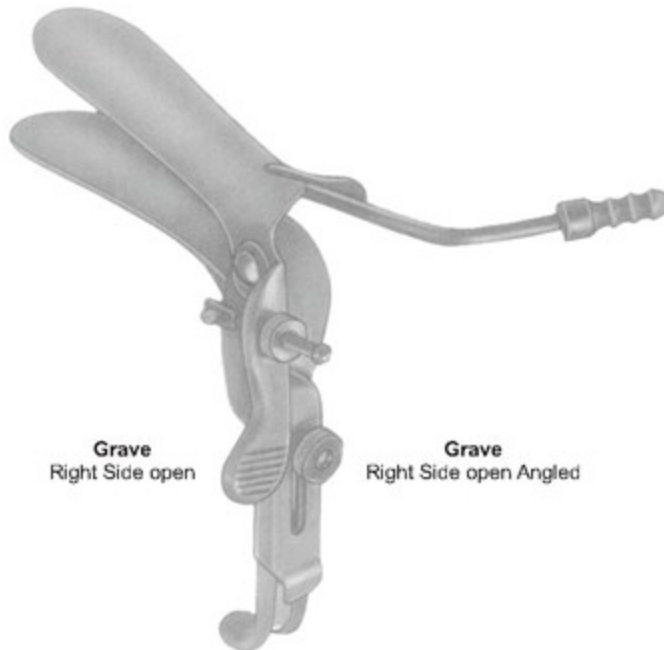

Grave
Right Side open

Grave
Right Side open Angled

	a mm	b mm
TBI 29-8012-01	101	
TBI 29-8012-02		35

Lateral Specula



TBI 29-8013-00



Pederson

	a	b
	mm	mm
TBI 29-8014-01	75	13
TBI 29-8014-02	100	22
TBI 29-8014-03	120	25
TBI 29-8014-04	130	25



Semm

	a	b
	mm	mm
TBI 29-8015-01	90	14/18
TBI 29-8015-02	100	17/20
TBI 29-8015-03	100	25/30



Nott

	a	b
	mm	mm
TBI 29-8016-01	90	30
TBI 29-8016-02	110	30

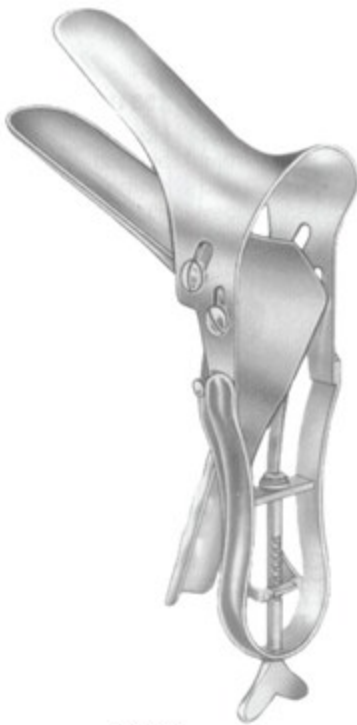

Seyffert

	a	b
	mm	mm
TBI 29-8017-01100	17	
TBI 29-8017-02110	33	

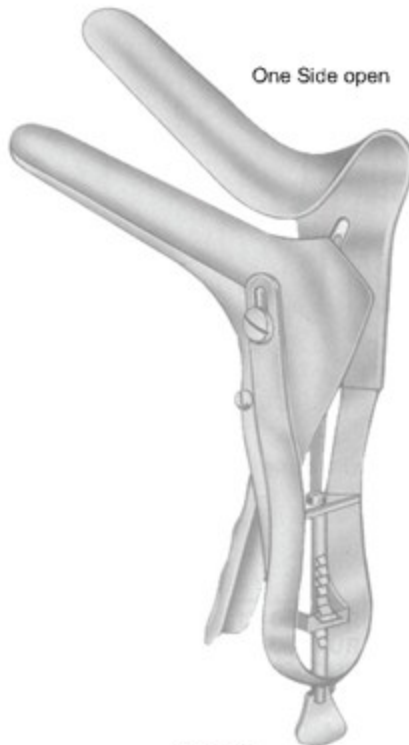

One Side open

Seyffert

	a	b
	mm	mm
TBI 29-8018-00	110	33



SAKURAI'S

TBI 29-8018-01 (LL)
TBI 29-8018-02 (L)
TBI 29-8018-03 (M)
TBI 29-8018-04 (S)





Sims (single ended)
TBI 29-8019-01 63 x 32 mm
TBI 29-8019-02 76 x 32 mm
TBI 29-8019-03 89 x 38 mm



Sims (double ended)
TBI 29-8020-01 65 x 25 mm (70 x 30 mm)
TBI 29-8020-02 70 x 35 mm (70 x 35 mm)
TBI 29-8020-03 85 x 35 mm (90 x 40 mm)
TBI 29-8020-04 100 x 35 mm x 40 mm
TBI 29-8020-05 120 x 35 mm x 40 mm



SIMS
TBI 29-8020-11 60 x 25mm
TBI 29-8020-12 70 x 30mm
TBI 29-8020-13 80 x 35mm



Jackson

Fig.	a mm	b mm
TBI 29-8021-01	1	75 X 35
TBI 29-8021-02	2	90 X 35
TBI 29-8021-03	3	100 X 35
TBI 29-8021-04	4	75 X 40
TBI 29-8021-05	5	90 x 40
TBI 29-8021-06	6	100 x 40



Eastman

Fig.	a mm	b mm
TBI 29-8022-01	1	75 X 35
TBI 29-8022-02	2	90 X 35
TBI 29-8022-03	3	100 X 35
TBI 29-8022-04	4	75 X 40
TBI 29-8022-05	5	90 x 40
TBI 29-8022-06	6	100 x 40

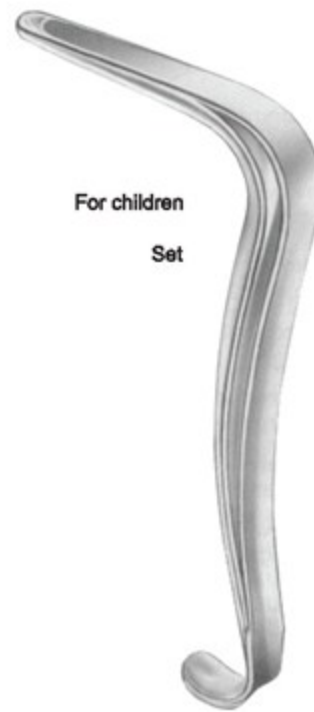

For children
Set

Kristeller
TBI 29-8023-00
70x15 mm

Specula

Set of 1 specula and 1 retractor

Fig. 1 TBI 29-8024-00
 Fig. 2 TBI 29-8025-00
 Fig. 3 TBI 29-8026-00

Specula

	Fig.	a mm	b mm
TBI 29-8027-01	1	70	27
TBI 29-8028-01	2	75	30
TBI 29-8029-01	3	90	36

Retractors

	Fig.	a mm	b mm
TBI 29-8030-02	1	75	23
TBI 29-8031-02	2	80	26
TBI 29-8032-02	3	95	32



Kristeller (Standard)

With conically shaped blades for virgins

Set of 1 specula and 1 retractor

Fig. 00 TBI 29-8033-00
 Fig. 0 TBI 29-8034-00

Specula

	Fig.	a mm	b mm
TBI 29-8035-01	00	110	18
TBI 29-8036-01	0	110	21

Retractors

	Fig.	a mm	b mm
TBI 29-8037-02	00	115	14
TBI 29-8038-02	0	115	17

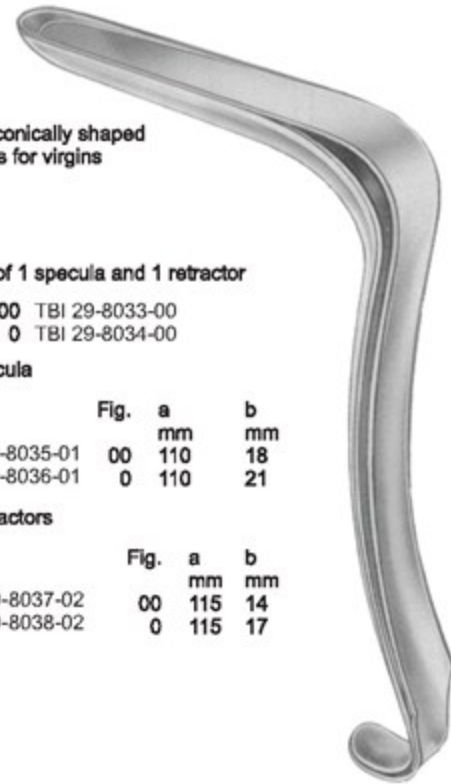

Kristeller

With extra long blades

Set of 1 specula and 1 retractor

Fig. 1 TBI 29-8039-00
 Fig. 2 TBI 29-8040-00
 Fig. 3 TBI 29-8041-00

Specula

	Fig.	a mm	b mm
TBI 29-8042-01	1	110	27
TBI 29-8043-01	2	110	30
TBI 29-8044-01	3	110	36

Retractors

	Fig.	a mm	b mm
TBI 29-8045-02	1	115	23
TBI 29-8046-02	2	115	26
TBI 29-8047-02	3	115	32

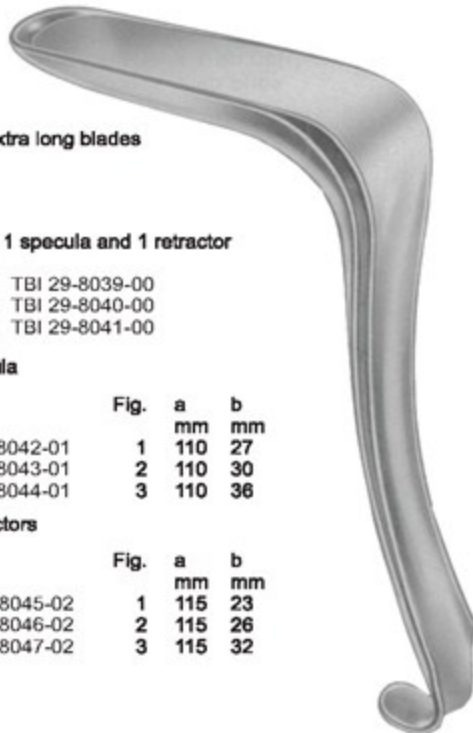

Kristeller (Standard)

With flat hollow specula



Set of 1 specula and 1 retractor

Fig. 1 TBI 29-8048-00
 Fig. 2 TBI 29-8049-00
 Fig. 3 TBI 29-8050-00

Specula

	Fig.	a mm	b mm
TBI 29-8051-011		105	26
TBI 29-8052-012		105	28
TBI 29-8053-013		105	33

Retractors

	Fig.	a mm	b mm
TBI 29-8054-021		115	22
TBI 29-8055-022		115	24
TBI 29-8056-023		115	29

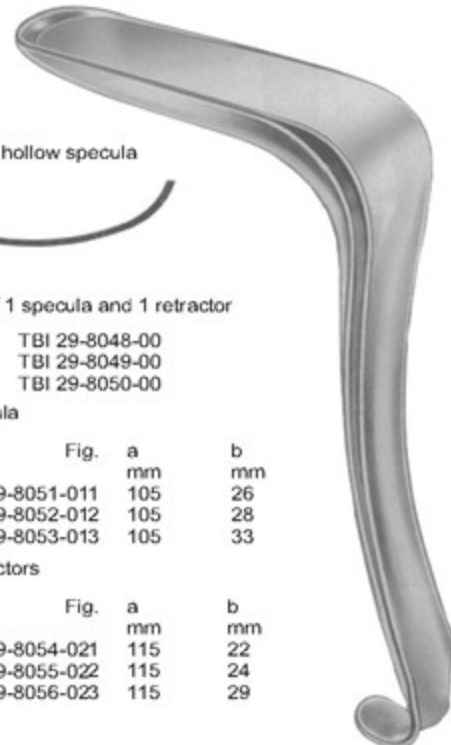

Kristeller



	a mm	b mm
TBI 29-8057-20	100	20
TBI 29-8057-25	100	25
TBI 29-8057-30	100	30
TBI 29-8057-35	100	35
TBI 29-8057-40	100	40
TBI 29-8058-20	130	20
TBI 29-8058-25	130	25
TBI 29-8058-30	130	30
TBI 29-8058-35	130	35
TBI 29-8058-40	130	40

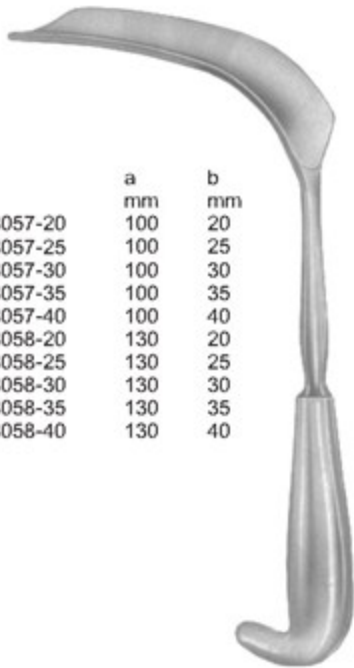

Matzenauer



Braun
TBI 29-8059-18
18 cm/7"
56x13 mm



Braun
TBI 29-8060-18
18 cm/7"
60x10 mm



Ulrich
TBI 29-8061-19
19.5 cm/7½"
80x20 mm



TBI 29-8062-19
19 cm/7½"
85x17 mm

Set	
TBI 29-8063-00	Fig. 1
TBI 29-8064-00	Fig. 2

Specula			
	Fig.	a mm	b mm
TBI 29-8065-01	1	70	40
TBI 29-8066-01	2	90	40

Retractors			
	Fig.	a mm	b mm
TBI 29-8067-02	1	70	33
TBI 29-8068-02	2	90	33

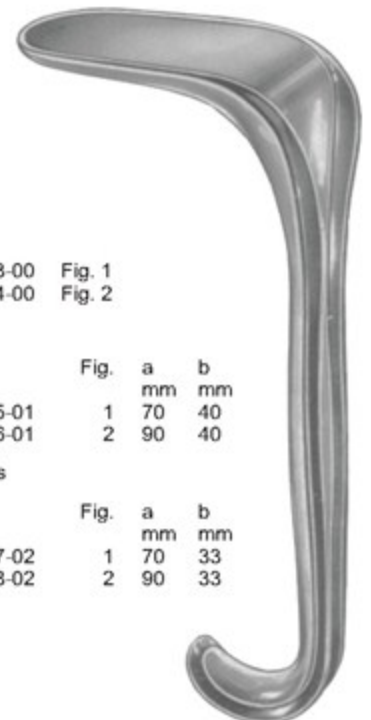

Kallmorgen

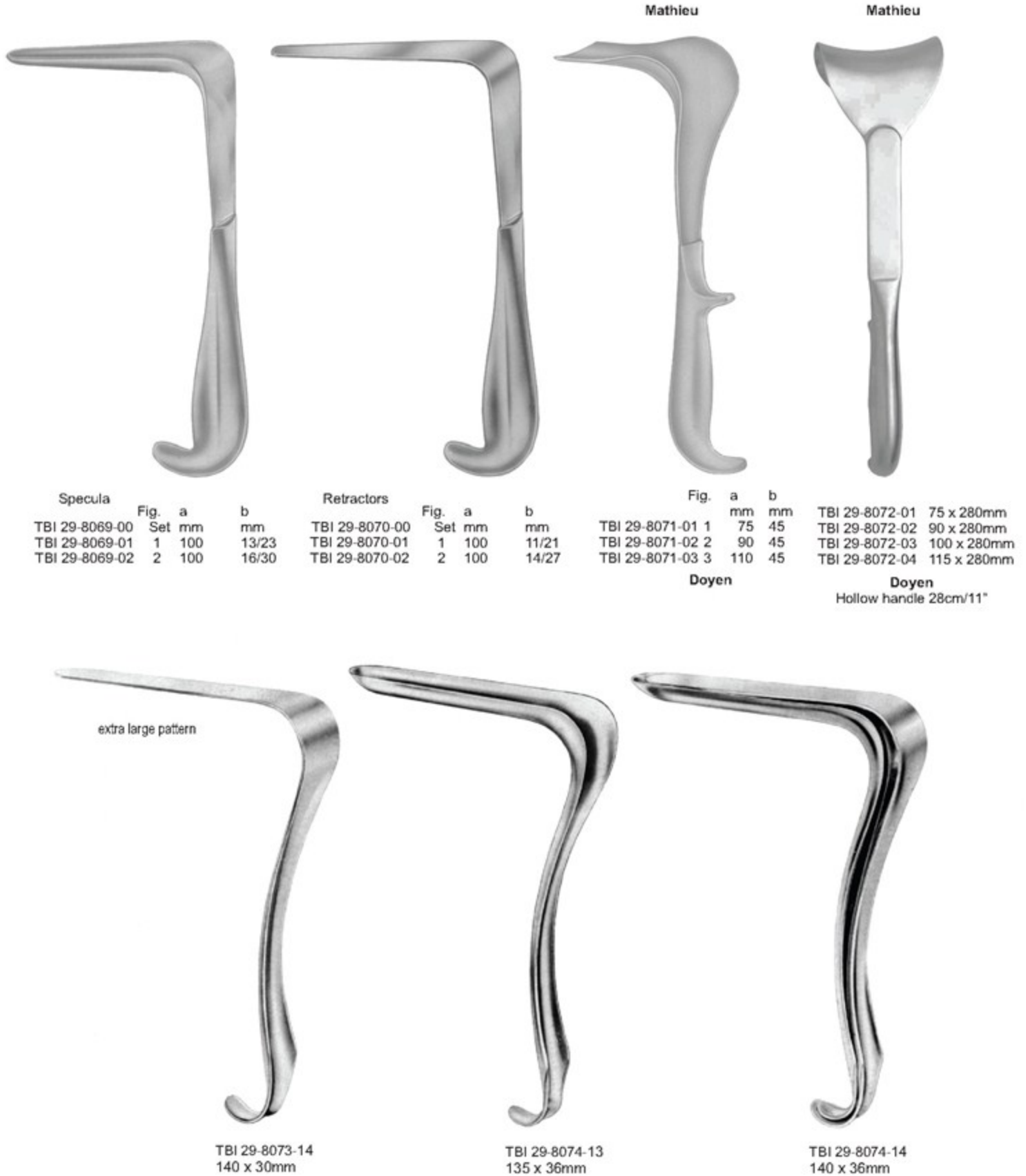

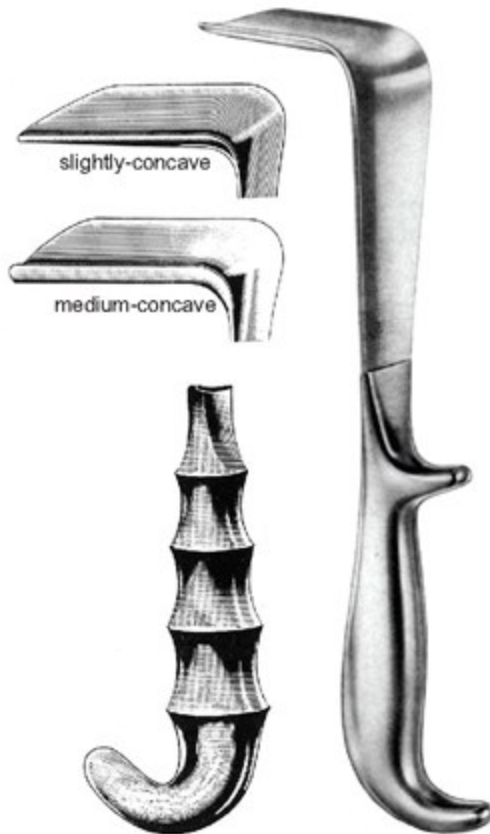
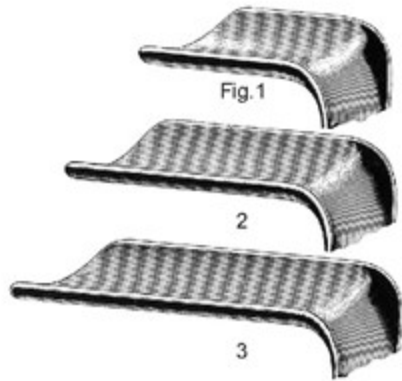

Fig	DOYEN FG		DOYEN		
	mm	mm	slightly-concave	slightly-concave	medium-concave
1	55	35	TBI 29-8075-11	TBI 29-8075-01	TBI 29-8078-01
2	85	35	TBI 29-8075-12	TBI 29-8075-02	TBI 29-8078-02
3	115	35	TBI 29-8075-13	TBI 29-8075-03	TBI 29-8078-03
1	55	45	TBI 29-8076-11	TBI 29-8076-01	TBI 29-8079-01
2	85	45	TBI 29-8076-12	TBI 29-8076-02	TBI 29-8079-02
3	115	45	TBI 29-8076-13	TBI 29-8076-03	TBI 29-8079-03
1	55	60	TBI 29-8077-11	TBI 29-8077-01	TBI 29-8080-01
2	85	60	TBI 29-8077-12	TBI 29-8077-02	TBI 29-8080-02
3	115	60	TBI 29-8077-13	TBI 29-8077-03	TBI 29-8080-03

DOYEN
TBI 29-8080-11 75 x 45mm
TBI 29-8080-12 90 x 45mm
TBI 29-8080-13 110 x 45mm

Doyen
25 cm/10"

	a mm	b mm
TBI 29-8081-01	60	30
TBI 29-8081-02	70	30
TBI 29-8081-03	80	30



AUVARD
 TBI 29-8082-01 80 x 38mm 2 lbs
 TBI 29-8082-02 80 x 38mm 2.5 lbs
 TBI 29-8082-03 80 x 38mm 3 lbs



AUVARD
 TBI 29-8082-00 68 x 40mm 3 lbs



AUVARD
 TBI 29-8082-04 2.5 lbs
 TBI 29-8082-05 3 lbs



Steiner-Auvard
 TBI 29-8083-01 140 x 35mm 2.5 lbs
 TBI 29-8083-02 140 x 35mm 2.5 lbs
 laser pattern



Henrotin
 TBI 29-8083-03 80 x 35mm 3 lbs
 30° blade angled down



Landau

	a	b
	mm	mm
TBI 29-8084-01	105	28
TBI 29-8084-02	105	38



Dunkel
 TBI 29-8084-22

95 x 45 cm



Breisky

	a	b
	mm	mm
TBI 29-8085-20	100	20
TBI 29-8085-25	100	25
TBI 29-8085-30	100	30
TBI 29-8085-35	100	35
TBI 29-8085-40	100	40
TBI 29-8086-20	130	20
TBI 29-8086-25	130	25
TBI 29-8086-30	130	30
TBI 29-8086-35	130	35
TBI 29-8086-40	130	40
TBI 29-8087-20	160	20
TBI 29-8087-25	160	25
TBI 29-8087-30	160	30
TBI 29-8087-35	160	35
TBI 29-8087-40	160	40
TBI 29-8088-20	180	20
TBI 29-8088-25	180	25
TBI 29-8088-30	180	30
TBI 29-8088-35	180	35
TBI 29-8088-40	180	40
TBI 29-8088-50	155	40



Berliind-Auvard
 TBI 29-8083-04
 105 x 40mm 2.5 lbs





A
TBI 29-8089-00
handle only

70 x 30mm
TBI 29-8089-01

80 x 35mm
TBI 29-8089-02

90 x 35mm
TBI 29-8089-03

100 x 35mm
TBI 29-8089-04

80 x 30mm
TBI 29-8089-05

85 x 33mm
TBI 29-8089-06

100 x 35mm
TBI 29-8089-07

110 x 42mm
TBI 29-8089-08

B
TBI 29-8089-10
handle only

BOZEMANN
TBI 29-8089-20 compl. set with handle A, B and 8 blades
TBI 29-8089-30 compl. set with handle A and 8 blades
TBI 29-8089-40 compl. set with handle B and 8 blades

Friedman
TBI 29-8090-20
10 cm/4"

Comyn Berkeley
Vulva self retaining
TBI 29-8090-15
15.5cm/6"

Joll
Thyroid self retaining
TBI 29-8091-15
15.5cm/6"

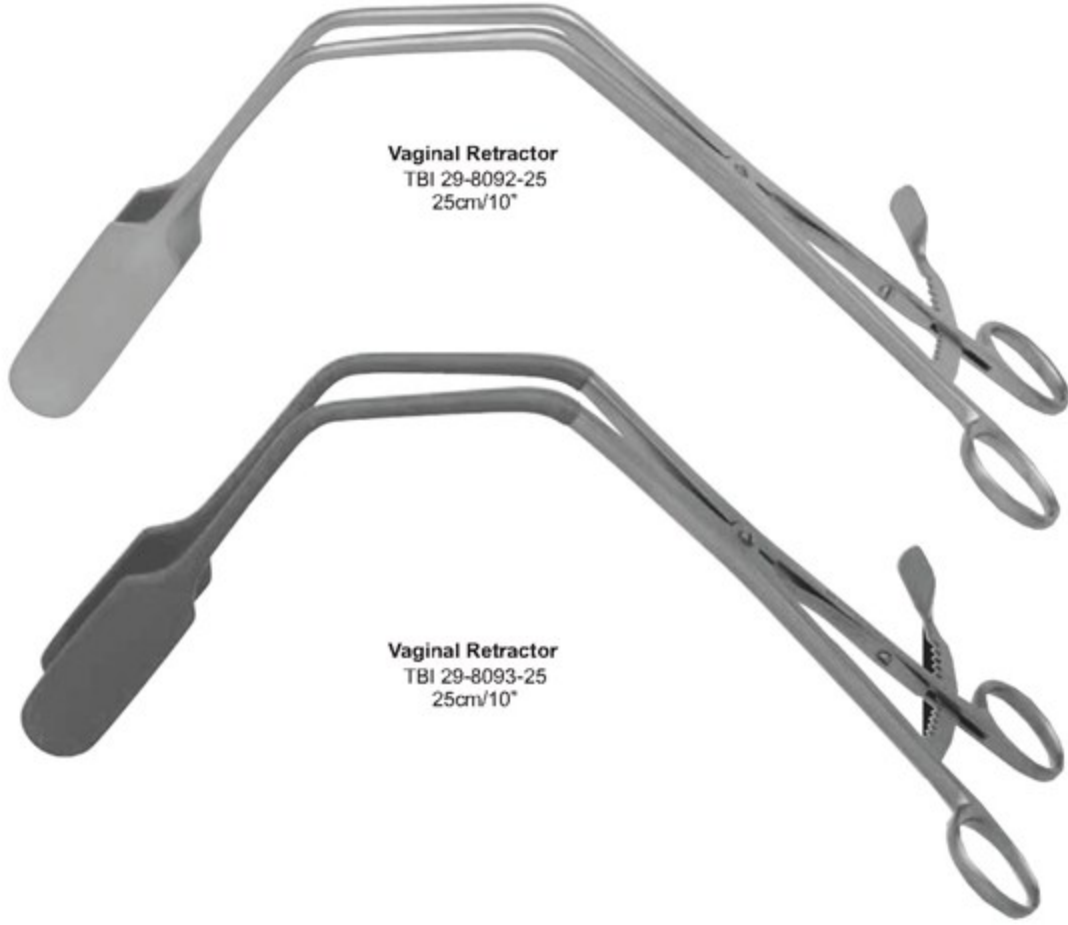
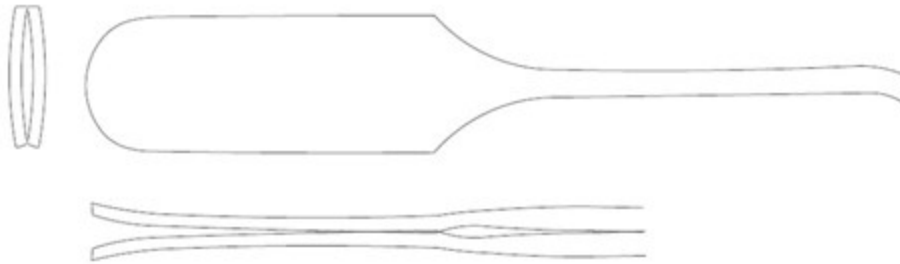

Vaginal Retractor
TBI 29-8092-25
25cm/10"

Vaginal Retractor
TBI 29-8093-25
25cm/10"





Scherbak
TBI 29-8094-00 Complete
TBI 29-8094-10 Handle only



TBI 29-8094-01
80x30 mm



TBI 29-8094-02
85x35 mm



TBI 29-8094-03
90x40 mm



TBI 29-8094-04
55x40/60 mm



TBI 29-8094-05
70x45/70 mm



Fig.	a mm	b mm
TBI 29-8095-01 1	45	17
TBI 29-8095-02 2	90	37
TBI 29-8095-03 3	90	45



O'Sullivan-O'Connor
TBI 29-8095-00
Complete



Hegar
 single ended
 18.5 cm long

mm Ø	TBI 29-8096-01	TBI 29-8096-51	mm dia.
1.0	TBI 29-8096-01	TBI 29-8096-51	1.5
2.0	TBI 29-8096-02	TBI 29-8096-52	2.5
3.0	TBI 29-8096-03	TBI 29-8096-53	3.5
4.0	TBI 29-8096-04	TBI 29-8096-54	4.5
5.0	TBI 29-8096-05	TBI 29-8096-55	5.5
6.0	TBI 29-8096-06	TBI 29-8096-56	6.5
7.0	TBI 29-8096-07	TBI 29-8096-57	7.5
8.0	TBI 29-8096-08	TBI 29-8096-58	8.5
9.0	TBI 29-8096-09	TBI 29-8096-59	9.5
10.0	TBI 29-8096-10	TBI 29-8096-60	10.5
11.0	TBI 29-8096-11	TBI 29-8096-61	11.5
12.0	TBI 29-8096-12	TBI 29-8096-62	12.5
13.0	TBI 29-8096-13	TBI 29-8096-63	13.5
14.0	TBI 29-8096-14	TBI 29-8096-64	14.5
15.0	TBI 29-8096-15	TBI 29-8096-65	15.5
16.0	TBI 29-8096-16	TBI 29-8096-66	16.5
17.0	TBI 29-8096-17	TBI 29-8096-67	17.5
18.0	TBI 29-8096-18	TBI 29-8096-68	18.5
19.0	TBI 29-8096-19	TBI 29-8096-69	19.5
20.0	TBI 29-8096-20	TBI 29-8096-70	20.5
21.0	TBI 29-8096-21	TBI 29-8096-71	21.5
22.0	TBI 29-8096-22	TBI 29-8096-72	22.5
23.0	TBI 29-8096-23	TBI 29-8096-73	23.5
24.0	TBI 29-8096-24	TBI 29-8096-74	24.5
25.0	TBI 29-8096-25	TBI 29-8096-75	25.5
26.0	TBI 29-8096-26	TBI 29-8096-76	26.5
27.0	TBI 29-8096-27	TBI 29-8096-77	27.5
28.0	TBI 29-8096-28	TBI 29-8096-78	28.5
29.0	TBI 29-8096-29	TBI 29-8096-79	29.5
30.0	TBI 29-8096-30	TBI 29-8096-80	30.5



Pieces per set

TBI 29-8097-10	14	4 - 17 mm
TBI 29-8097-20	26	1 - 26 mm
TBI 29-8097-30	30	1 - 30 mm



Pieces per set

TBI 29-8098-40	14	4 - 17 mm
TBI 29-8098-50	26	1 - 26 mm
TBI 29-8098-60	30	1 - 30 mm



Hegar
 double ended
 20 cm long

Ø mm	TBI 29-8099-02
1/2	TBI 29-8099-02
3/4	TBI 29-8099-04
5/6	TBI 29-8099-06
7/8	TBI 29-8099-08
9/10	TBI 29-8099-10
11/12	TBI 29-8099-12
13/14	TBI 29-8099-14
15/16	TBI 29-8099-16
17/18	TBI 29-8099-18
19/20	TBI 29-8099-20
21/22	TBI 29-8099-22
23/24	TBI 29-8099-24
25/26	TBI 29-8099-26

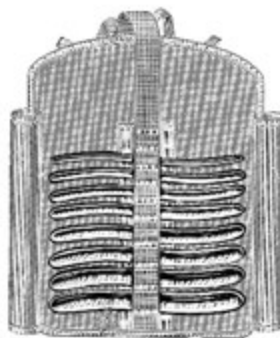

Pieces per set set

TBI 29-8100-00	08	3/4 - 17/18 mm	TBI 29-8100-30
TBI 29-8100-01	13	1/2 - 25/26 mm	TBI 29-8100-31





mm	
3/6	TBI 29-8102-03
4/7	TBI 29-8102-04
5/8	TBI 29-8102-05
6/9	TBI 29-8102-06
7/10	TBI 29-8102-07
8/11	TBI 29-8102-08
9/12	TBI 29-8102-09
10/13	TBI 29-8102-10
11/14	TBI 29-8102-11
12/15	TBI 29-8102-12
13/16	TBI 29-8102-13
14/17	TBI 29-8102-14
15/18	TBI 29-8102-15
16/19	TBI 29-8102-16
17/20	TBI 29-8102-17
18/21	TBI 29-8102-18

Hawkin Ambler

TBI 29-8101-12 Set of 12 3/6 - 14/17
TBI 29-8101-16 Set of 16 3/6 - 18/21
17 cm long



Hank
TBI 29-8103-30

mm	
9/10	TBI 29-8104-10
11/12	TBI 29-8104-12
13/14	TBI 29-8104-14
15/16	TBI 29-8104-16
17/18	TBI 29-8104-18
19/20	TBI 29-8104-20

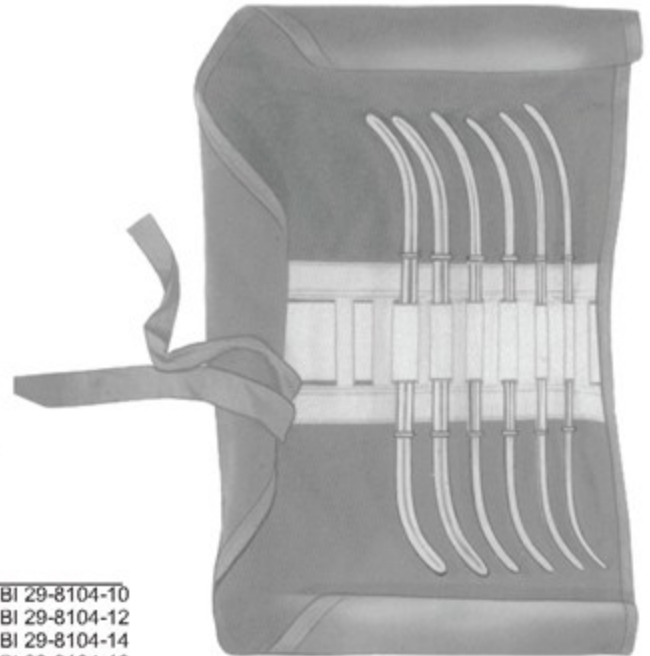

Set
TBI 29-8105-00
double ended
27 cm



mm	
13/15	TBI 29-8106-15
17/19	TBI 29-8106-19
21/23	TBI 29-8106-23
25/27	TBI 29-8106-27
29/31	TBI 29-8106-31
33/35	TBI 29-8106-35
37/39	TBI 29-8106-39
41/43	TBI 29-8106-43

Pratt

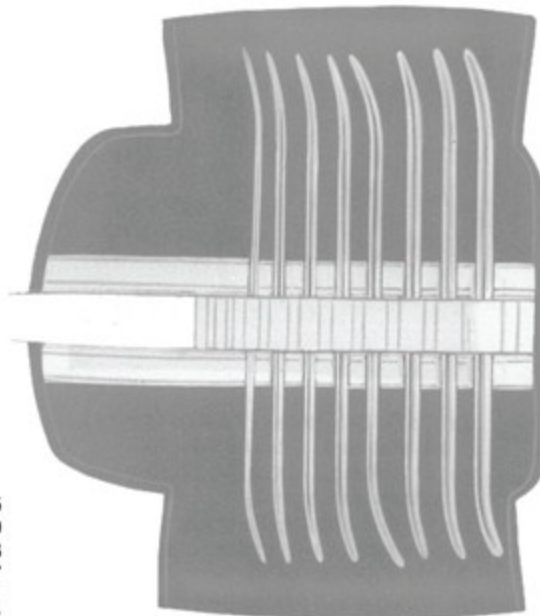

Set
TBI 29-8106-00
double ended
29 cm



Jolly

TBI 29-8107-00 set of 5
TBI 29-8107-01 3-7 mm dia
TBI 29-8107-02 5-9 mm dia
TBI 29-8107-03 7-12 mm dia
TBI 29-8107-04 9-15 mm dia
TBI 29-8107-05 12-18 mm dia

Tip 4 mm



Sims
 32 cm/12½"
 cm
 TBI 29-8108-01 s/s



Martin (Simpson)
 32 cm/12½"
 cm
 TBI 29-8109-01 s/s



Valleix
 TBI 29-8110-25
 25 cm/10"



Collin
 TBI 29-8111-28
 28 cm/11"

Uterine Depressor



Braun
 TBI 29-8112-28
 28 cm/11"

Rigid

Malleable

cm / in
 TBI 29-8108-02 s/s
 TBI 29-8108-03 c/p

cm / in
 TBI 29-8109-02 s/s
 TBI 29-8109-03 c/p





SIMS
TBI 29-8113-26
26.0cm



FANO
TBI 29-8114-22
22.0cm



RAPID
TBI 29-8115-01 200 x 8mm
TBI 29-8115-02 250 x 10mm
TBI 29-8115-03 250 x 12mm



SIMS
TBI 29-8116-27
27.0cm

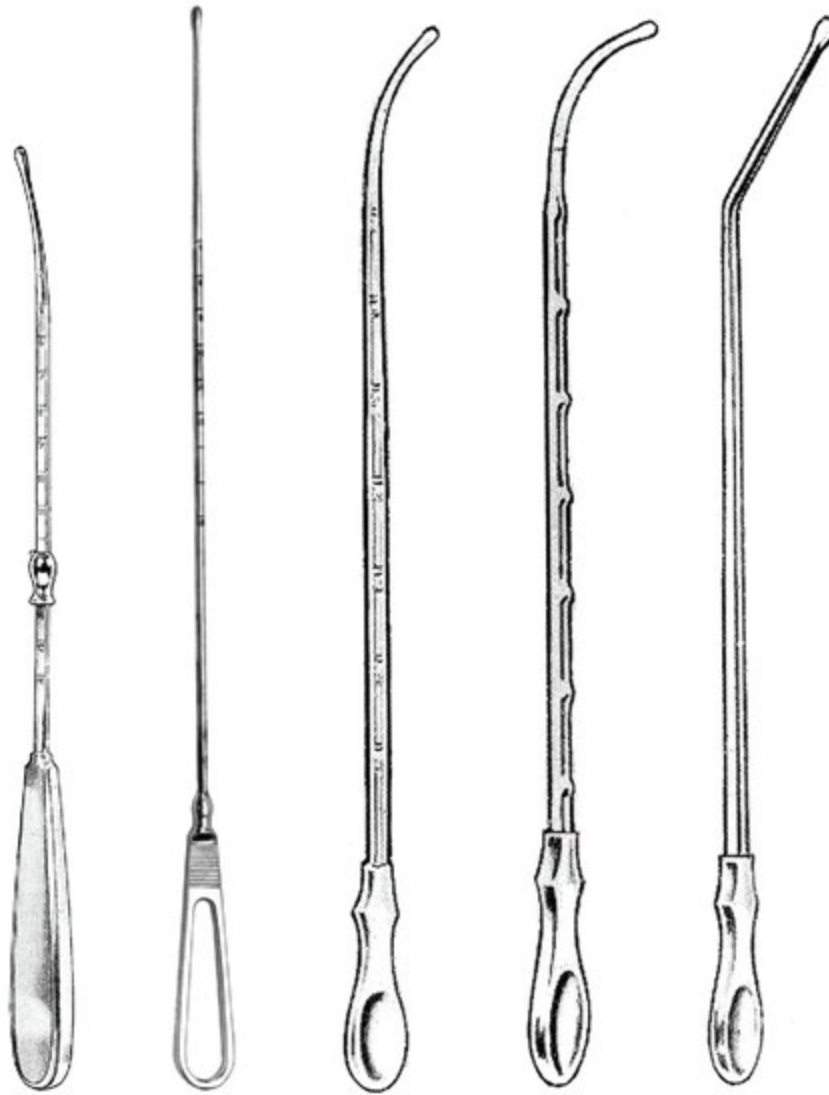

VALLEIX
 TBI 29-8117-25
 25.0cm

TBI 29-8118-30
 30.5cm

GALABIN
 TBI 29-8119-32
 32.0cm

HORROCKS
 TBI 29-8120-32
 32.0cm

SIMPSON
 TBI 29-8121-32
 32.0cm



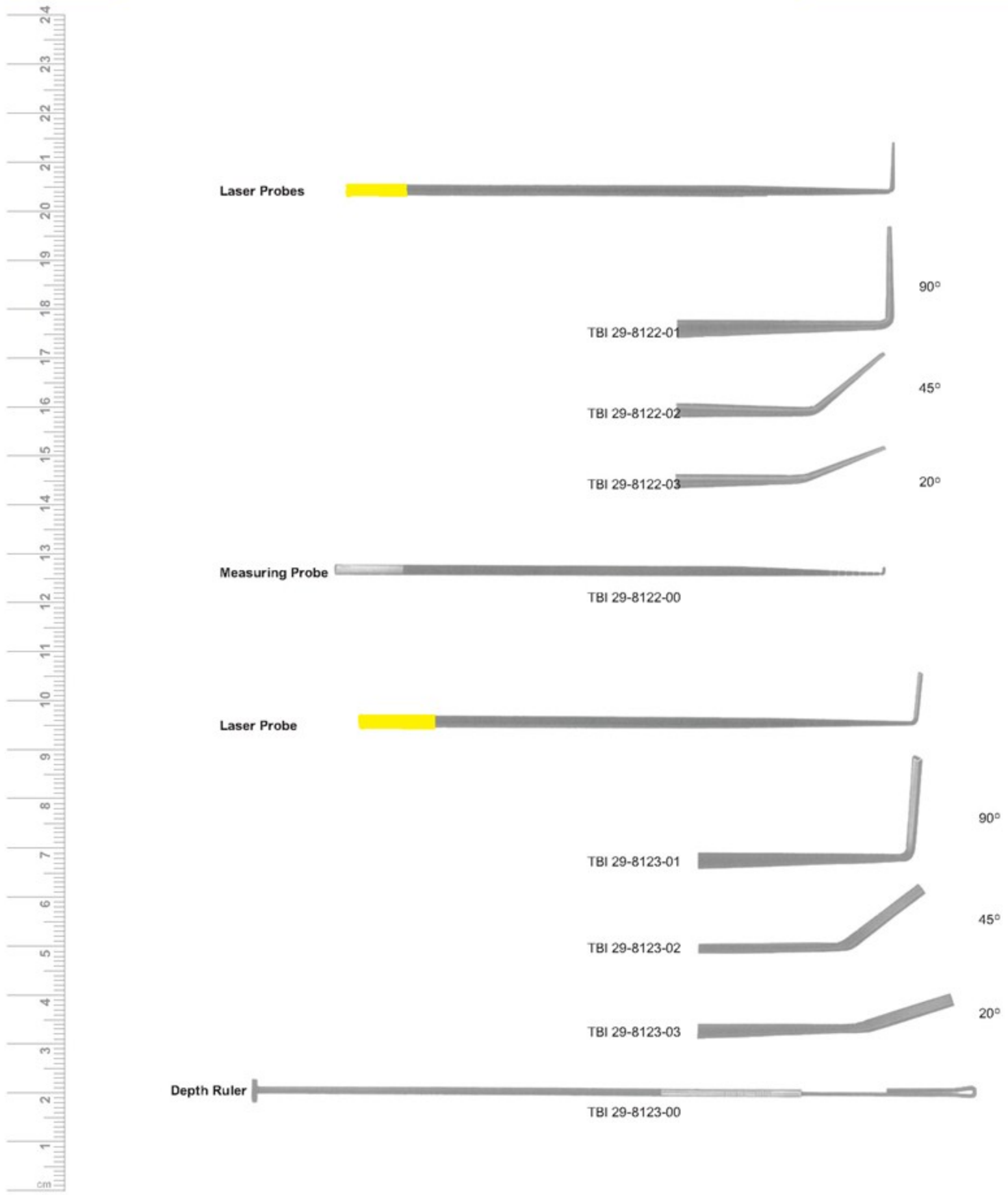

Measuring Instruments



Hooks

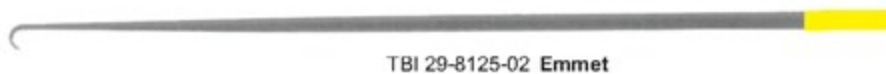
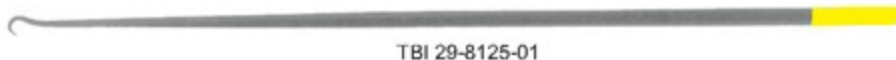

- Corn Knives, Fistula Hooks, Myoma Instruments
- Konusmesser, Fistelhaken, Myom-instrumente
- Bisturi p. conos de atraccion, Ganchos p. fistulas



Ayre
TBI 29-8128-23
23 cm/9"



Simon
TBI 29-8129-22
22 cm/8¾"



Simon
TBI 29-8130-22
22 cm/8¾"



Emmet
22 cm/8¾"



TBI 29-8131-01



TBI 29-8131-02



TBI 29-8131-03



TBI 29-8131-04



TBI 29-8131-05



TBI 29-8132-24
24.0cm



Doyen
TBI 29-8132-17 T-Handle
TBI 29-8132-18 Loop-Handle
17 cm/6¾"



Doyen
TBI 29-8133-17 T-Handle
TBI 29-8133-18 Loop-Handle
17 cm/6¾"



Segond
TBI 29-8134-27
27 cm/10½"

Secretion Spoon



TBI 29-8135-27
 27 cm/10½"



Muenchen
 27 cm/10½"



TBI 29-8136-04
 4 mm



TBI 29-8136-05
 5 mm



Randall
 24 cm/9½"

4 mmØ

- TBI 29-8137-01 1 mm
- TBI 29-8137-02 2 mm
- TBI 29-8137-03 3 mm
- TBI 29-8137-04 4 mm



Novak
 23 cm/9"

- TBI 29-8138-01 1 mm
- TBI 29-8138-02 2 mm
- TBI 29-8138-03 3 mm
- TBI 29-8138-04 4 mm



Novak-Schoeckaert
 TBI 29-8139-24
 24 cm/9"





Kevorkian malleable
 TBI 29-8140-30 TBI 29-8141-30
 30 cm/12" 30 cm/12"



Kevorkian malleable
 TBI 29-8142-30 TBI 29-8143-30
 30 cm/12" 30 cm/12"



Townsend malleable
 TBI 29-8144-30 TBI 29-8145-30
 31 cm/12 1/4" 31 cm/12 1/4"



Duncan
 TBI 29-8146-31
 31 cm/12 1/4"



Duncan
 TBI 29-8147-31
 31 cm/12 1/4"



Goodell
TBI 29-8148-34
34 cm/13 1/2"



Kogan-Laser
24 cm

Black Insulated



TBI 29-8149-28



TBI 29-8150-28



TBI 29-8151-28
28 cm/11"



Kogan
TBI 29-8152-24 24 cm
TBI 29-8152-48 48 cm

Kogan
TBI 29-8153-24 24 cm
TBI 29-8153-48 48 cm



Kogan
28 cm/11"



TBI 29-8154-28



TBI 29-8155-28





Martin
 TBI 29-8156-27
 27 cm/10½"



Staude-Moore
 TBI 29-8157-17
 17 cm/6¾"



Barrett
 TBI 29-8158-18
 18 cm/7"



Schroeder
 TBI 29-8159-10
 25 cm/10"



Teale
 TBI 29-8159-18 18.0cm
 TBI 29-8159-23 23.0cm
 TBI 29-8159-25 25.0cm



Braun
 TBI 29-8160-25
 25 cm/10"



Collin-Pozzi
 TBI 29-8161-25
 25 cm/10"



Pozzi
 TBI 29-8162-01
 25.5 cm/10¼"



Pozzi
 TBI 29-8162-02
 25.0cm



Duplay
 TBI 29-8163-28
 28 cm/11"

Amniotome for the
amnion Bladder



Skene
TBI 29-8164-24
24 cm/9 1/2"



Skene
TBI 29-8164-23
23.0cm



Beacham
TBI 29-8165-26
26 cm/10 1/4"



Czerny
TBI 29-8166-20
20.5 cm/8 1/4"



TBI 29-8167-26
26 cm/10 1/4"



Henrotin
TBI 29-8167-20
20.0cm



Abel
TBI 29-8168-27
27.0cm



Schroeder
TBI 29-8168-23 23 cm
TBI 29-8168-24 24 cm
TBI 29-8168-26 26 cm
Straight



Schroeder
TBI 29-8169-23
TBI 29-8169-24
TBI 29-8169-26

Curved on Flat



Schroeder
TBI 29-8170-23
TBI 29-8170-24
TBI 29-8170-26

Curved Sideway



Atrauma
TBI 29-8171-29
Vulsellum Forcep
29cm/11 1/2"



Luer
TBI 29-8172-30
Vulsellum Forcep
30.5cm/12"





Atrauma
TBI 29-8173-29
29cm/11 1/2"



Bozeman
TBI 29-8174-27
27cm/10 1/2"

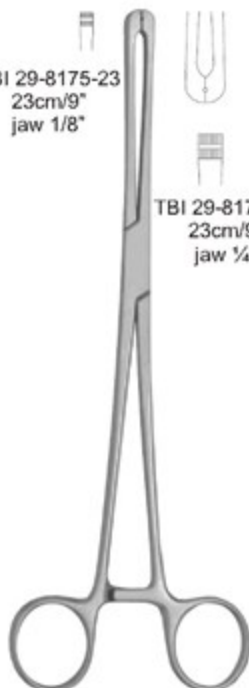

TBI 29-8175-23
23cm/9"
jaw 1/8"

TBI 29-8176-23
23cm/9"
jaw 1/4"



Rotunda
TBI 29-8177-27
27cm/10 1/2"



Bierer
TBI 29-8178-24
24cm/9 1/2"



MUSEUX 24.0cm
straight curved
sideway

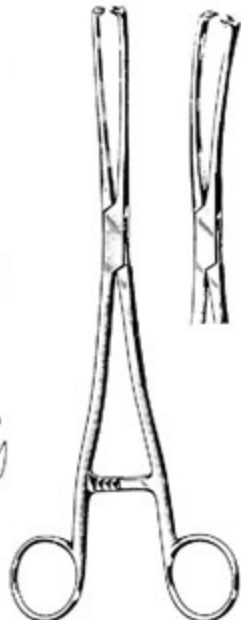

MUSEUX 24.0cm
straight curved
sideway



MUSEUX 26.0cm
straight curved
sideway

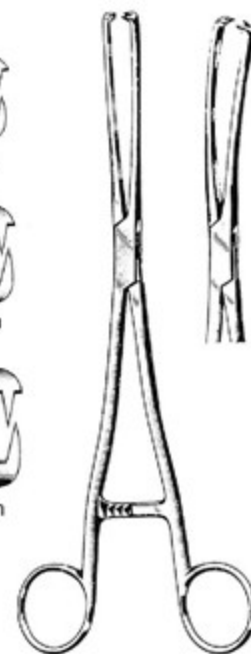

MUSEUX 26.0cm
straight curved
sideway

TBI 29-8179-06	6mm	TBI 29-8179-16	TBI 29-8180-06	6mm	TBI 29-8180-16	TBI 29-8181-09	9mm	TBI 29-8181-16	TBI 29-8182-09	9mm	TBI 29-8182-16
TBI 29-8179-08	8mm	TBI 29-8179-18	TBI 29-8180-08	8mm	TBI 29-8180-18	TBI 29-8181-11	11mm	TBI 29-8181-18	TBI 29-8182-11	11mm	TBI 29-8182-18
TBI 29-8179-10	10mm	TBI 29-8179-20	TBI 29-8180-10	10mm	TBI 29-8180-20	TBI 29-8181-13	13mm	TBI 29-8181-20	TBI 29-8182-13	13mm	TBI 29-8182-20

For the amnion Bladder



Pratt
 TBI 29-8183-28
 28 cm/11"



Iowa
 TBI 29-8184-26
 26 cm/10 1/4"



Jacobs
 Straight Curved Sideway
 TBI 29-8185-21 TBI 29-8186-21
 21 cm/8 1/4"



Bonney Polypus
 TBI 29-8187-26
 24 cm/9 1/2"



Kelly
 TBI 29-8188-32
 32 cm/12 1/2"



Heywood-Smith
 TBI 29-8189-20
 20 cm/8"



Heywood-Smith
 TBI 29-8190-25
 25 cm/10"



Noto
 TBI 29-8191-27
 27 cm/10 1/2"

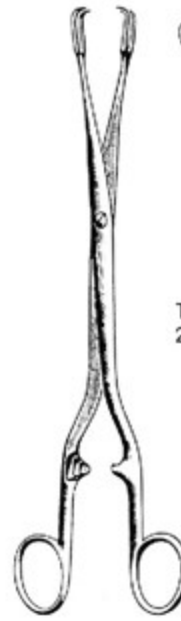

Schroeder
 TBI 29-8192-01
 26.0cm

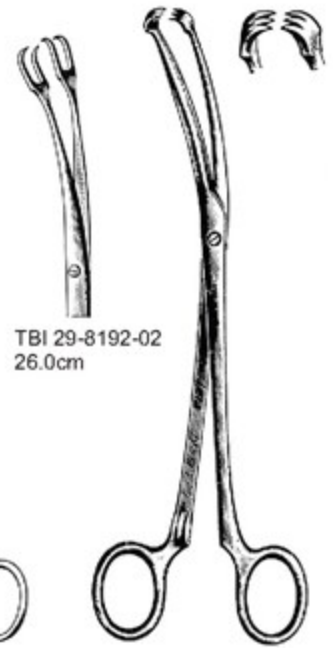

Teale
 TBI 29-8193-18 18.0cm
 TBI 29-8193-23 23.0cm





Dartigues
TBI 29-8194-27
27 cm/10½"



Sommer
TBI 29-8195-23
23 cm/9"



Collin
TBI 29-8196-25
25 cm/10"



Doyen
TBI 29-8197-18 18 cm/7"
TBI 29-8197-20 20 cm/8"

Ovarian Forceps



Pruesmann
TBI 29-8197-27
27.5cm



Bonney
TBI 29-8198-27
27 cm/11"



Bonney
TBI 29-8199-27
27 cm/10½"



Bonney
TBI 29-8200-20
20 cm/8"
curved



Bonney Berkley
TBI 29-8201-20
20 cm/8"
angled





THOMS-GAYLOR
TBI 29-8202-24
24.0cm



THOMS-GAYLOR
TBI 29-8203-22 22.0cm
TBI 29-8203-24 24.0cm



VAN DOREN
24.0cm



TBI 29-8204-01

TBI 29-8204-02



GELLHORN
TBI 29-8205-23
23.0cm



FAURE
TBI 29-8206-21
21.0cm



SCHUBERT
TBI 29-8207-26
26.0cm



SCHUBERT
TBI 29-8208-21 21.0cm
TBI 29-8208-29 29.0cm



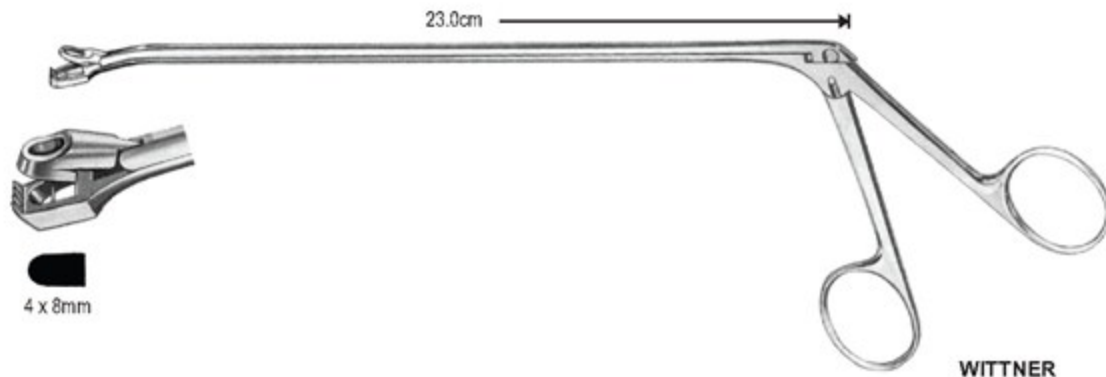

WITTNER
 TBI 29-8209-23 23.0cm (straight)
 TBI 29-8210-23 23.0cm (angled)

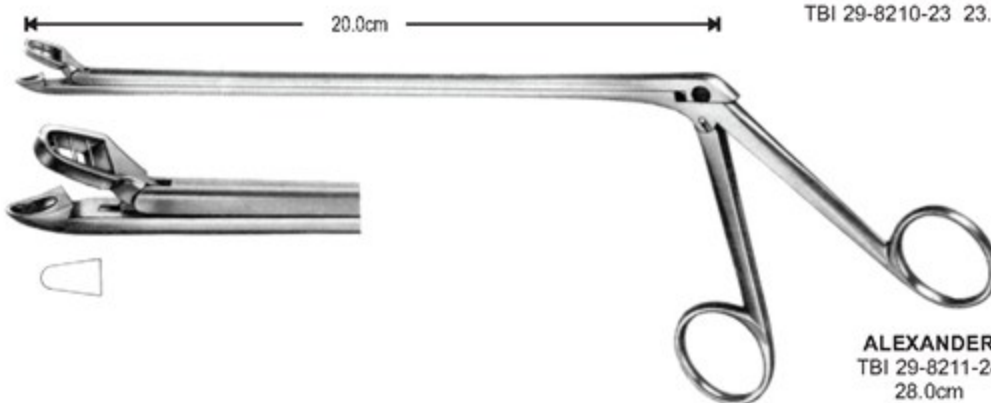

ALEXANDER
 TBI 29-8211-28
 28.0cm

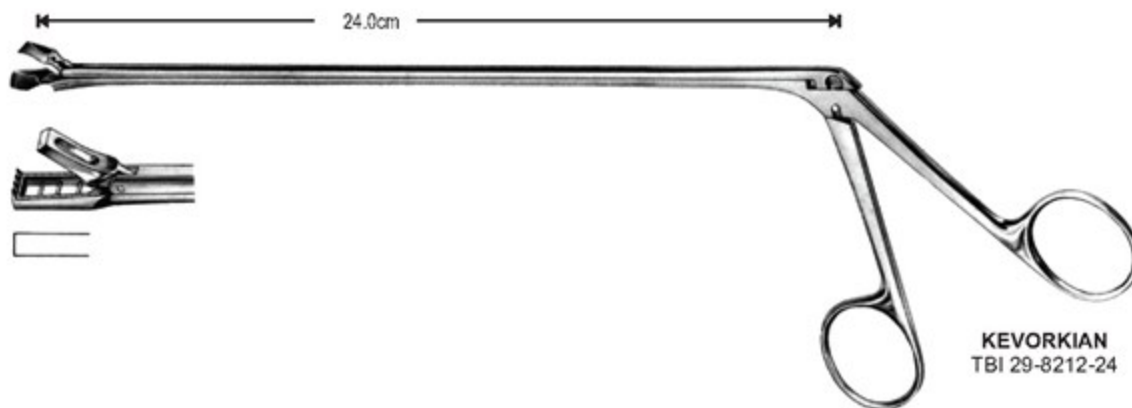

KEVORKIAN
 TBI 29-8212-24

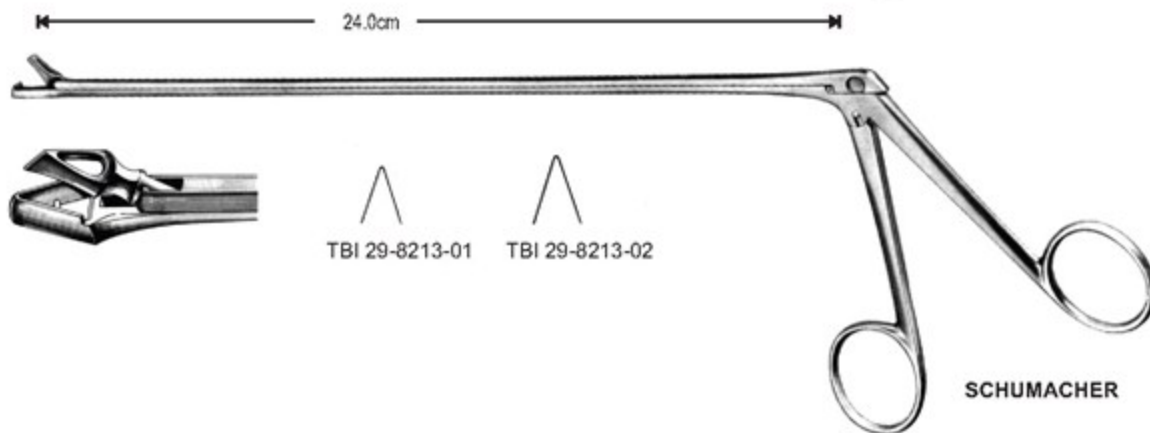

SCHUMACHER



2.3 x 4.2 mm

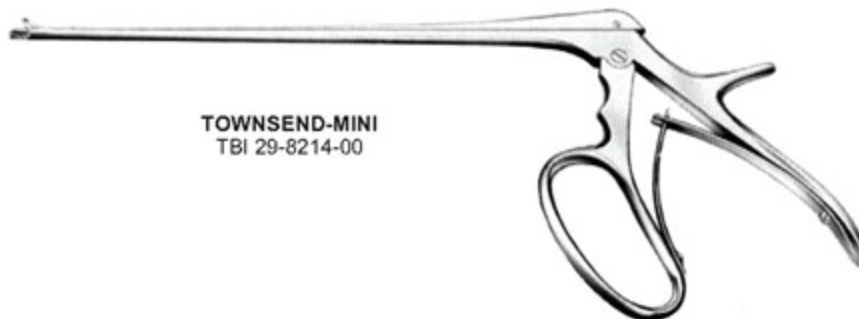

TOWNSEND-MINI
 TBI 29-8214-00



3 x 9.5 mm



TISCHLER-KEVORKIAN
 TBI 29-8215-00



4 x 6.5 mm

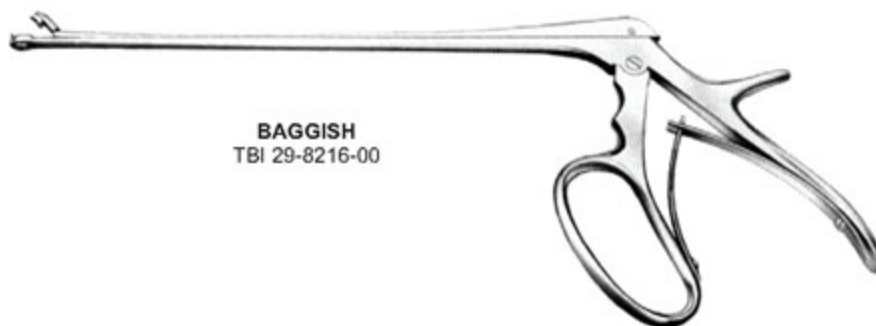

BAGGISH
 TBI 29-8216-00



4 x 8 mm

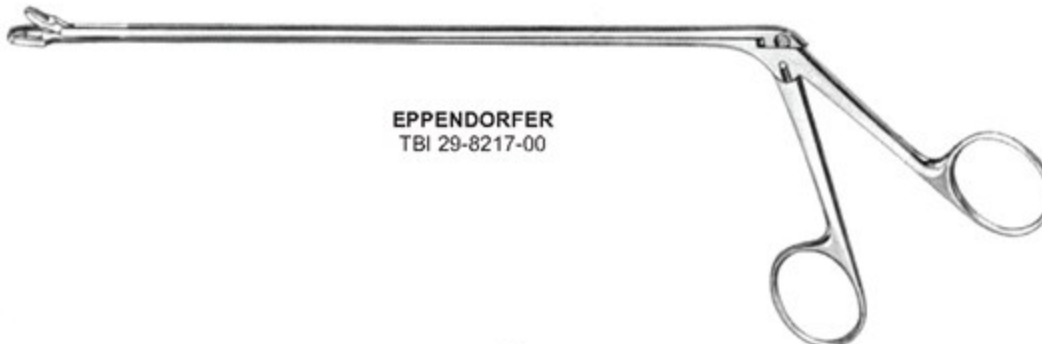

EPPENDORFER
 TBI 29-8217-00





oval
7 x 5 mm



3 x 8 mm



Fig.1

TISCHLER-MORGAN



Fig.3

oval ● 3.7 x 5 mm



Fig.4

KEVORKIAN



Fig.5

mini



Tip only



TBI 29-8221-01

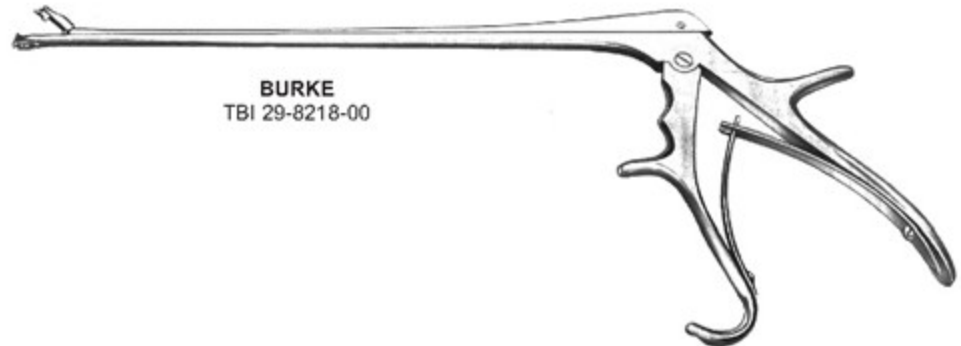

BURKE
TBI 29-8218-00

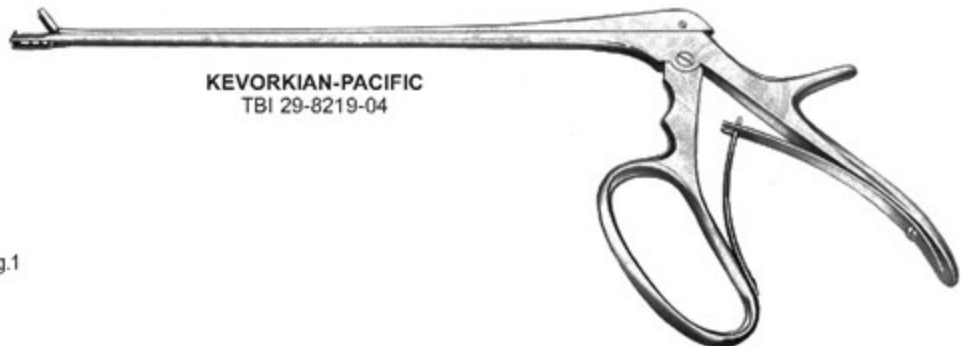

KEVORKIAN-PACIFIC
TBI 29-8219-04

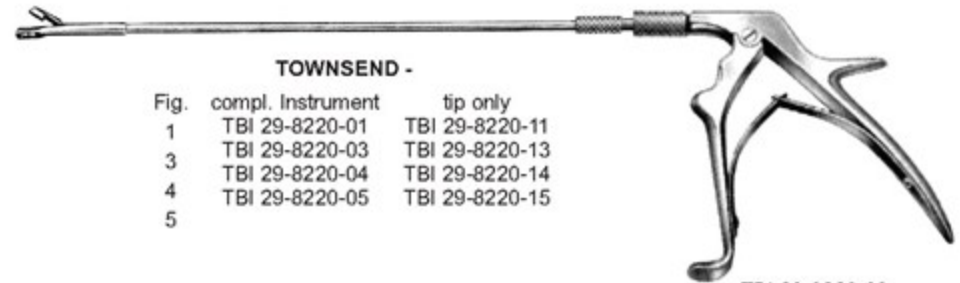

TOWNSEND -

Fig.	compl. Instrument	tip only
1	TBI 29-8220-01	TBI 29-8220-11
3	TBI 29-8220-03	TBI 29-8220-13
4	TBI 29-8220-04	TBI 29-8220-14
5	TBI 29-8220-05	TBI 29-8220-15

TBI 29-8220-99
handle only

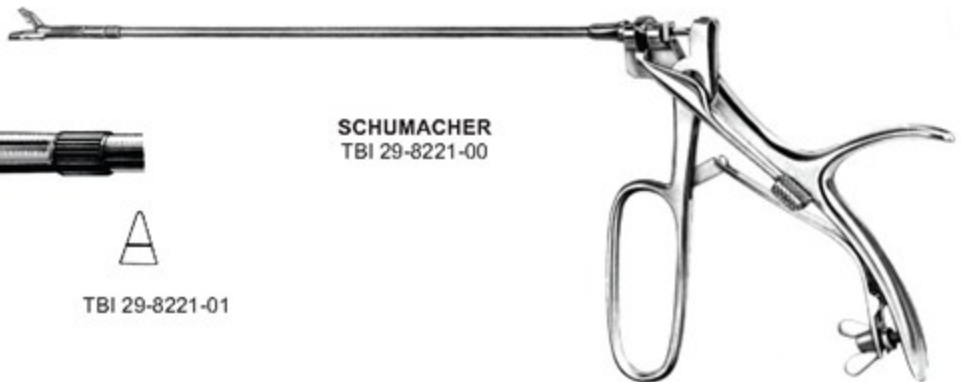

SCHUMACHER
TBI 29-8221-00



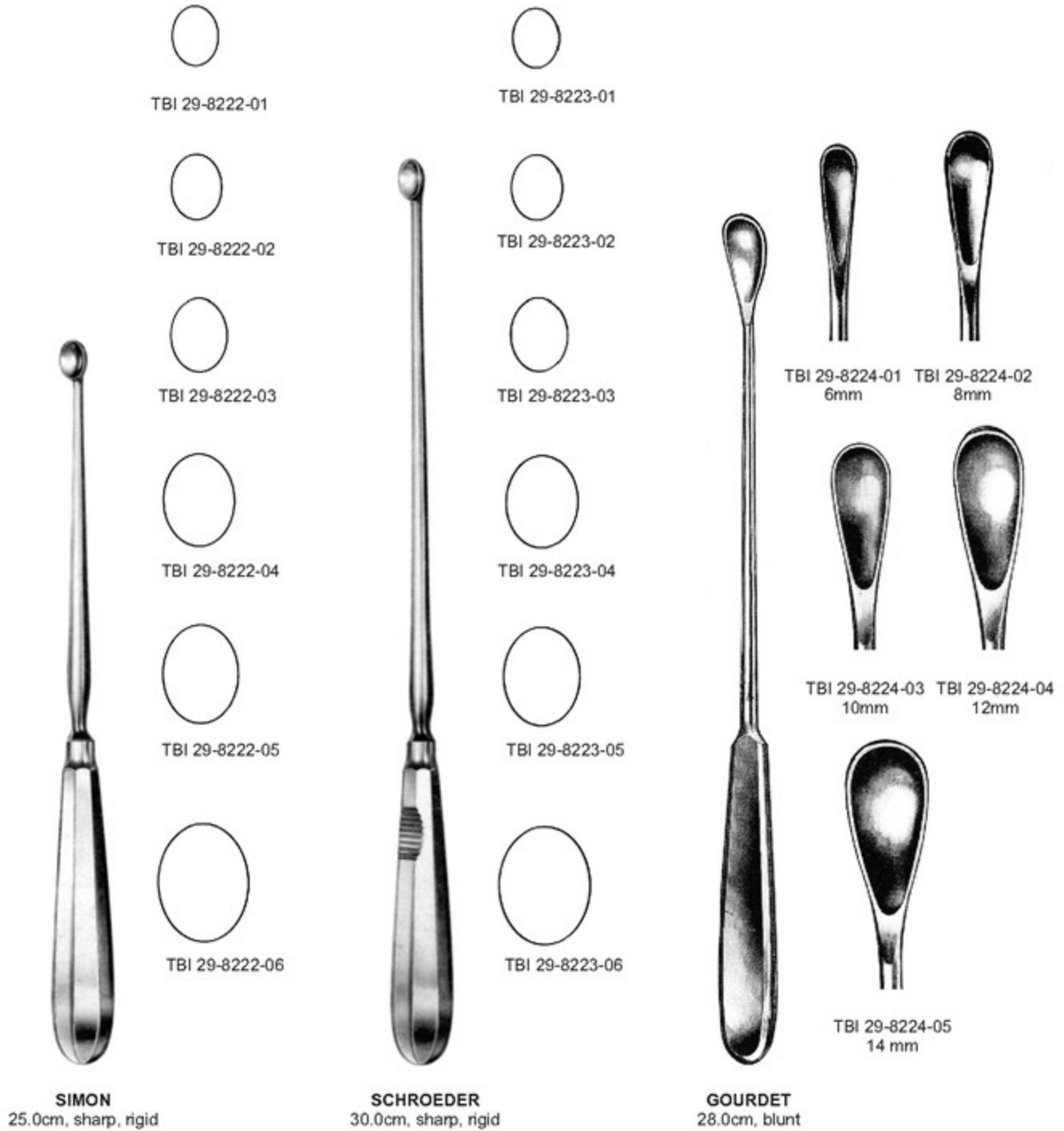

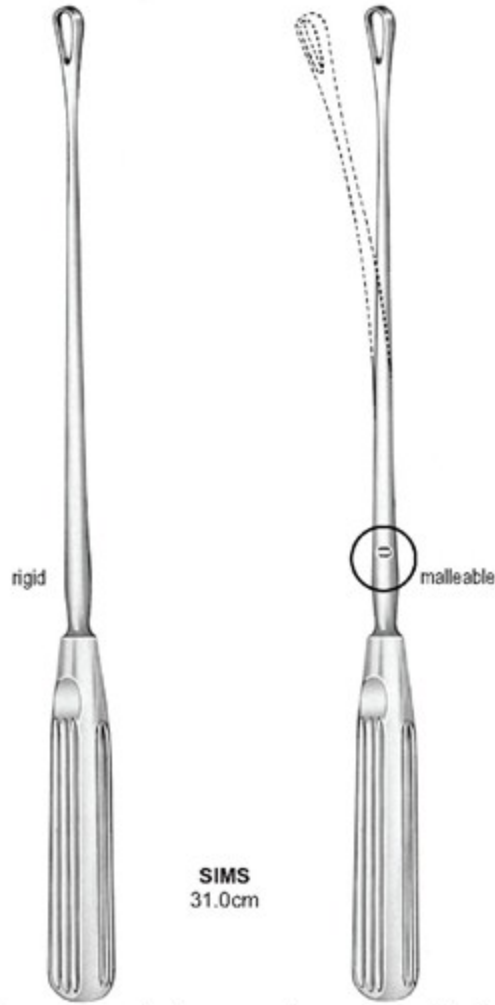

SIMS
31.0cm

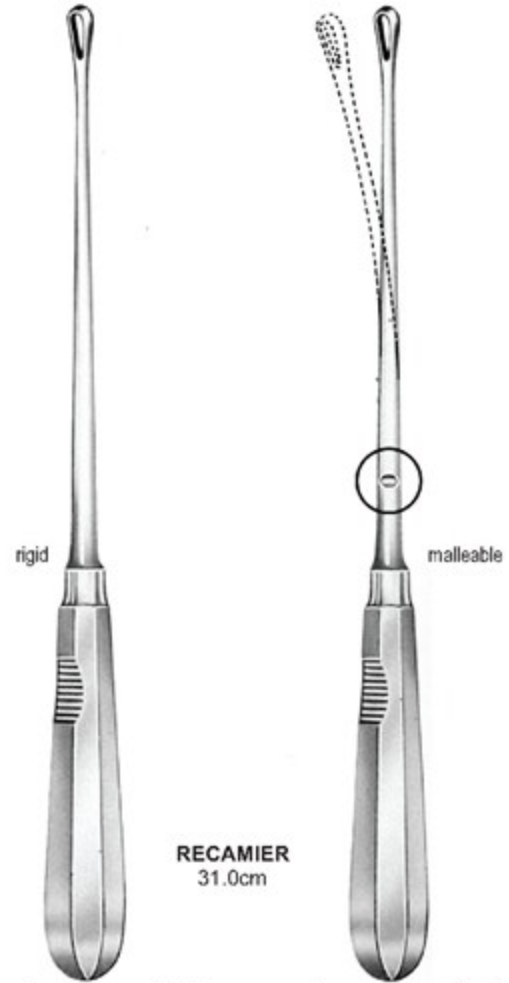

RECAMIER
31.0cm

Fig	sharp	blunt	sharp	blunt
00	TBI 29-8225-05	TBI 29-8226-05	TBI 29-8227-05	TBI 29-8228-05
0	TBI 29-8225-06	TBI 29-8226-06	TBI 29-8227-06	TBI 29-8228-06
1	TBI 29-8225-07	TBI 29-8226-07	TBI 29-8227-07	TBI 29-8228-07
2	TBI 29-8225-08	TBI 29-8226-08	TBI 29-8227-08	TBI 29-8228-08
3	TBI 29-8225-09	TBI 29-8226-09	TBI 29-8227-09	TBI 29-8228-09
4	TBI 29-8225-11	TBI 29-8226-11	TBI 29-8227-11	TBI 29-8228-11
5	TBI 29-8225-12	TBI 29-8226-12	TBI 29-8227-12	TBI 29-8228-12
6	TBI 29-8225-14	TBI 29-8226-14	TBI 29-8227-14	TBI 29-8228-14
7	TBI 29-8225-15	TBI 29-8226-15	TBI 29-8227-15	TBI 29-8228-15
8	TBI 29-8225-16	TBI 29-8226-16	TBI 29-8227-16	TBI 29-8228-16
9	TBI 29-8225-19	TBI 29-8226-19	TBI 29-8227-19	TBI 29-8228-19
10	TBI 29-8225-20	TBI 29-8226-20	TBI 29-8227-20	TBI 29-8228-20
11	TBI 29-8225-21	TBI 29-8226-21	TBI 29-8227-21	TBI 29-8228-21
12	TBI 29-8225-23	TBI 29-8226-23	TBI 29-8227-23	TBI 29-8228-23
13	TBI 29-8225-25	TBI 29-8226-25	TBI 29-8227-25	TBI 29-8228-25
14	TBI 29-8225-30	TBI 29-8226-30	TBI 29-8227-30	TBI 29-8228-30
15	TBI 29-8225-35	TBI 29-8226-35	TBI 29-8227-35	TBI 29-8228-35
16	TBI 29-8225-40	TBI 29-8226-40	TBI 29-8227-40	TBI 29-8228-40

Fig	sharp	blunt	sharp	blunt
00	TBI 29-8229-05	TBI 29-8230-05	TBI 29-8231-05	TBI 29-8232-05
0	TBI 29-8229-06	TBI 29-8230-06	TBI 29-8231-06	TBI 29-8232-06
1	TBI 29-8229-07	TBI 29-8230-07	TBI 29-8231-07	TBI 29-8232-07
2	TBI 29-8229-08	TBI 29-8230-08	TBI 29-8231-08	TBI 29-8232-08
3	TBI 29-8229-09	TBI 29-8230-09	TBI 29-8231-09	TBI 29-8232-09
4	TBI 29-8229-11	TBI 29-8230-11	TBI 29-8231-11	TBI 29-8232-11
5	TBI 29-8229-12	TBI 29-8230-12	TBI 29-8231-12	TBI 29-8232-12
6	TBI 29-8229-14	TBI 29-8230-14	TBI 29-8231-14	TBI 29-8232-14
7	TBI 29-8229-15	TBI 29-8230-15	TBI 29-8231-15	TBI 29-8232-15
8	TBI 29-8229-16	TBI 29-8230-16	TBI 29-8231-16	TBI 29-8232-16
9	TBI 29-8229-19	TBI 29-8230-19	TBI 29-8231-19	TBI 29-8232-19
10	TBI 29-8229-20	TBI 29-8230-20	TBI 29-8231-20	TBI 29-8232-20
11	TBI 29-8229-21	TBI 29-8230-21	TBI 29-8231-21	TBI 29-8232-21
12	TBI 29-8229-23	TBI 29-8230-23	TBI 29-8231-23	TBI 29-8232-23
13	TBI 29-8229-25	TBI 29-8230-25	TBI 29-8231-25	TBI 29-8232-25
14	TBI 29-8229-30	TBI 29-8230-30	TBI 29-8231-30	TBI 29-8232-30
15	TBI 29-8229-35	TBI 29-8230-35	TBI 29-8231-35	TBI 29-8232-35
16	TBI 29-8229-40	TBI 29-8230-40	TBI 29-8231-40	TBI 29-8232-40

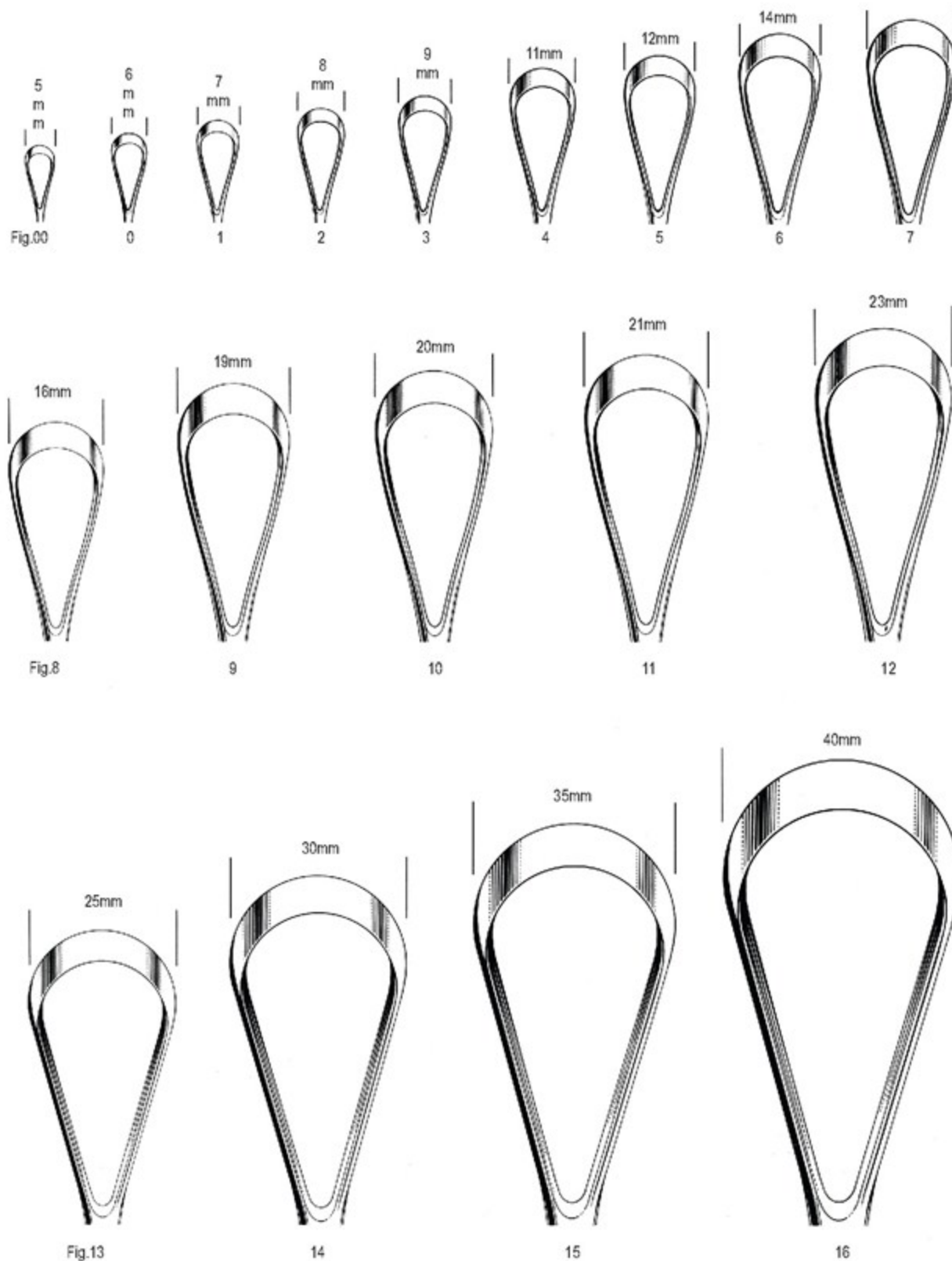

Fig.13

14

15

16



BUMM
34.0cm



Fig	sharp	blunt	sharp	blunt
13	TBI 29-8233-25	TBI 29-8234-25	TBI 29-8235-25	TBI 29-8236-25
14	TBI 29-8233-30	TBI 29-8234-30	TBI 29-8235-30	TBI 29-8236-30
15	TBI 29-8233-35	TBI 29-8234-35	TBI 29-8235-35	TBI 29-8236-35
16	TBI 29-8233-40	TBI 29-8234-40	TBI 29-8235-40	TBI 29-8236-40

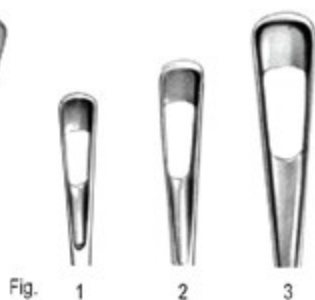

Fig.

1

2

3



4



5

28.0cm

Fig.		mm
1	TBI 29-8237-01	4.5
2	TBI 29-8237-02	6
3	TBI 29-8237-03	9
4	TBI 29-8237-04	12
5	TBI 29-8237-05	15



Fig.

1

2

3



4



5

OLSHAUSEN'S
 27.0cm

Fig.	
1	TBI 29-8238-01
2	TBI 29-8238-02
3	TBI 29-8238-03
4	TBI 29-8238-04
5	TBI 29-8238-05

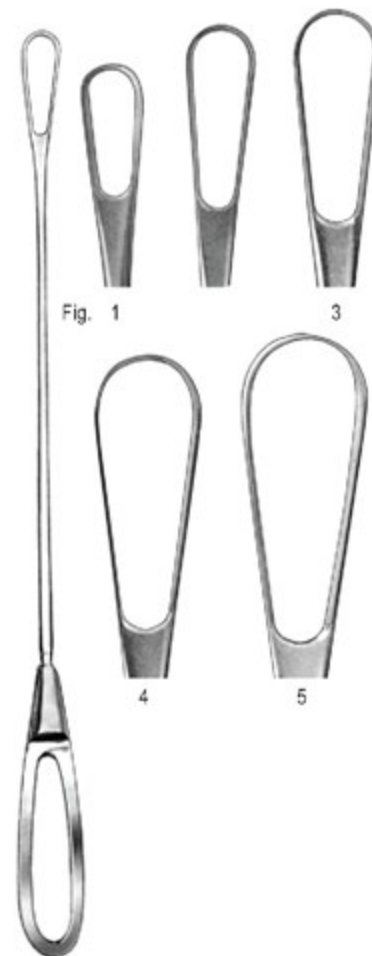

Fig.

1

2

3



4



5

BUMM'S
 28.0cm

Fig.	
1	TBI 29-8239-01
2	TBI 29-8239-02
3	TBI 29-8239-03
4	TBI 29-8239-04
5	TBI 29-8239-05



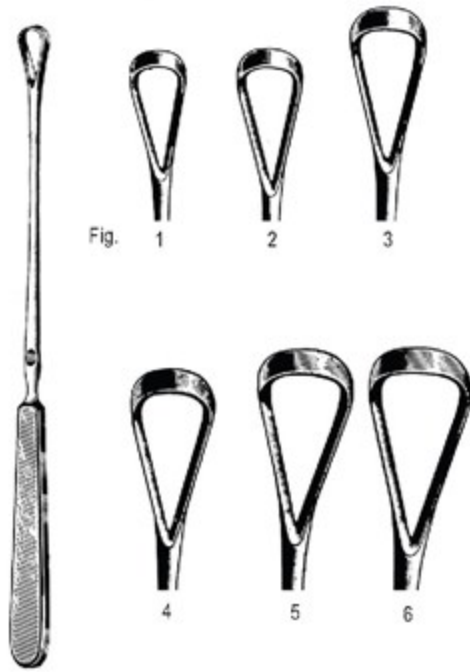

Fig.

1

2

3

4

5

6

SIMS
25.0cm

sharp

Fig

blunt

TBI 29-8240-01	1	TBI 29-8241-01
TBI 29-8240-02	2	TBI 29-8241-02
TBI 29-8240-03	3	TBI 29-8241-03
TBI 29-8240-04	4	TBI 29-8241-04
TBI 29-8240-05	5	TBI 29-8241-05
TBI 29-8240-06	6	TBI 29-8241-06

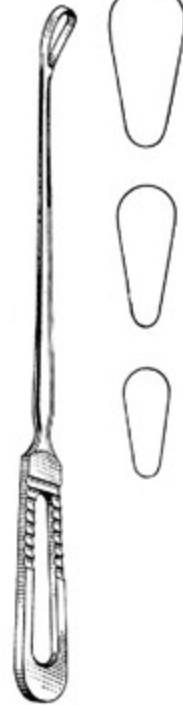

SIMS
25.0cm

sharp

Fig

blunt

TBI 29-8242-01	1	TBI 29-8243-01
TBI 29-8242-02	2	TBI 29-8243-02
TBI 29-8242-03	3	TBI 29-8243-03

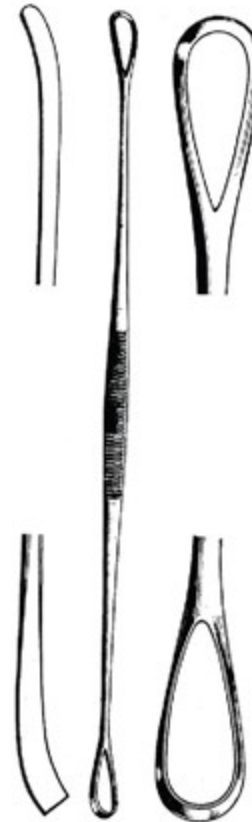

sharp / blunt

TBI 29-8244-27 27.0cm



BLAKE

sharp / blunt

TBI 29-8245-27 27.0cm



SIMS
TBI 29-8246-25
25.0cm, sharp



SIMS
TBI 29-8247-25
25.0cm, sharp / blunt



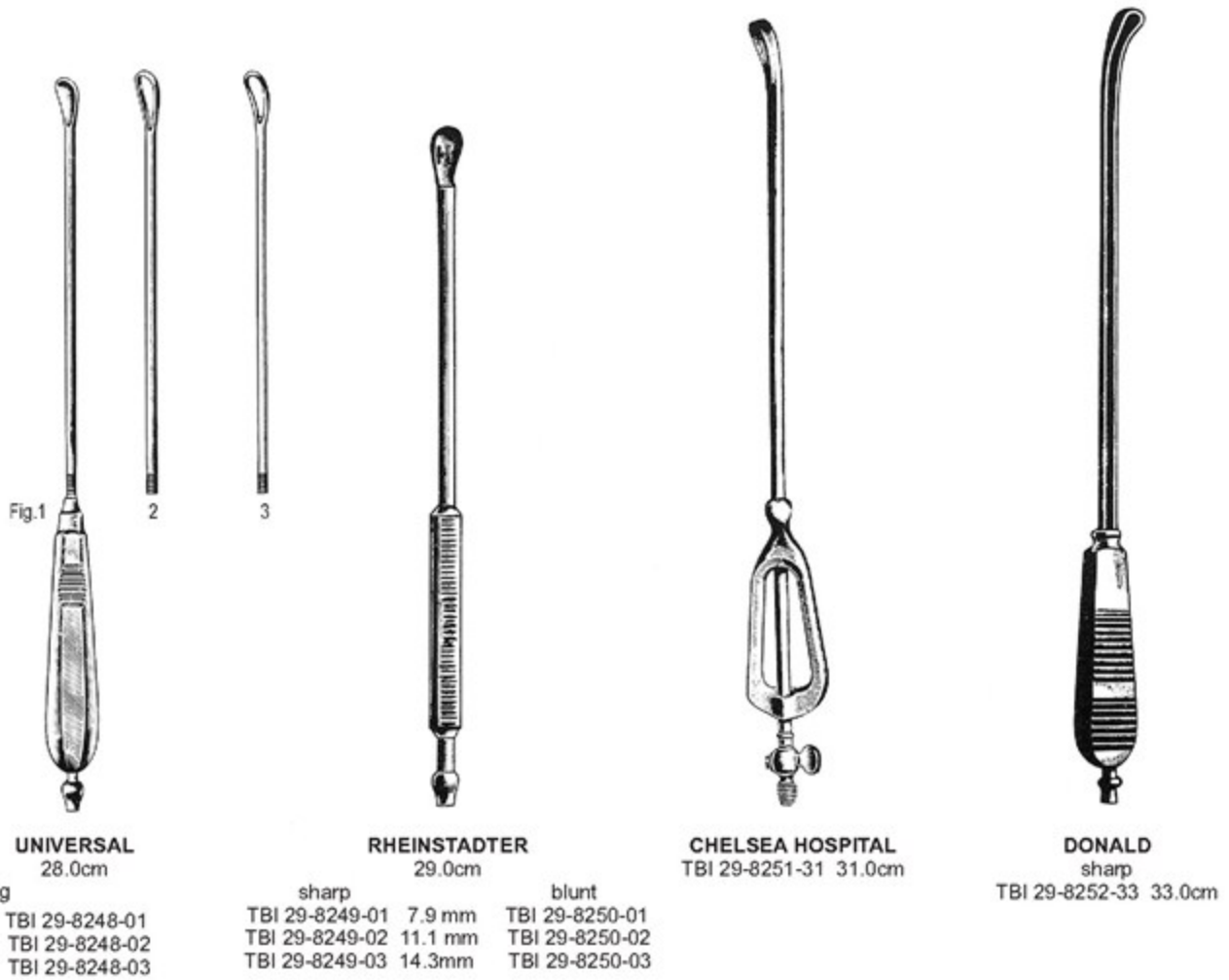



RANDALL
 24.0cm
 1mm dia. TBI 29-8253-01
 2mm dia. TBI 29-8253-02
 3mm dia. TBI 29-8253-03
 4mm dia. TBI 29-8253-04



NOVAK
 23.0cm
 TBI 29-8254-01
 TBI 29-8254-02
 TBI 29-8254-03
 TBI 29-8254-04



SHERMAN
 TBI 29-8255-23 23.0cm
 3.5mm dia.

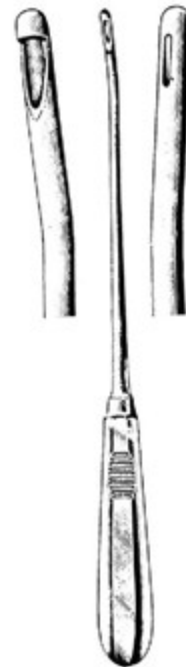

MUENCHEN
 TBI 29-8256-27 27.0cm



with basket

KEVORKIAN
 30.0cm
 TBI 29-8257-12 1.2mm TBI 29-8258-12
 TBI 29-8257-40 4.0mm TBI 29-8258-40

- EN** Obstetrics
- DE** Geburtshilfe
- ES** Obstetricia

Page 723 to 740

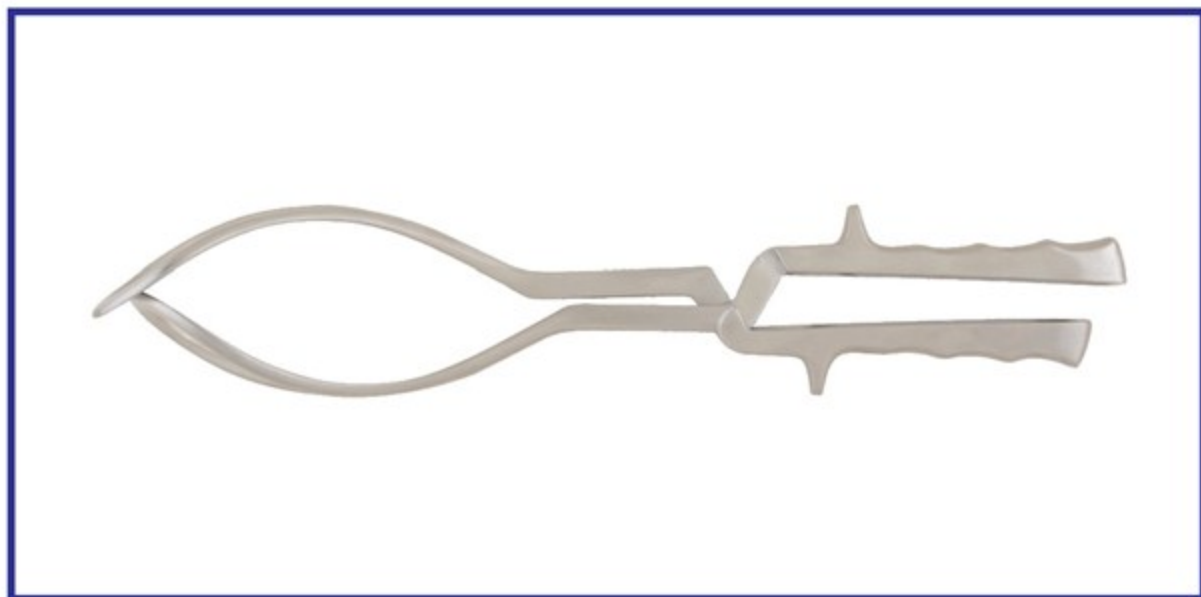



WRIGLEY
TBI 30-8401-23 23.0cm
TBI 30-8401-28 28.0cm



DE-LEE
TBI 30-8402-30
30.0cm



DE-LEE
TBI 30-8403-36
36.0cm



SIMPSON
TBI 30-8404-23 23.0cm, str.
TBI 30-8405-23 23.0cm, cvd.



SIMPSON
TBI 30-8406-23 23.0cm
TBI 30-8406-30 30.0cm



SIMPSON-BRAUN
TBI 30-8407-33 33.0cm
TBI 30-8407-36 36.0cm



KIELLAND
TBI 30-8408-41
41.0cm



PIPER
TBI 30-8409-44
44.0cm



ELLIOT
 TBI 30-8410-32 32.0cm
 TBI 30-8410-38 38.0cm



NAEGELE
 TBI 30-8411-36 36.0cm
 TBI 30-8411-40 40.0cm



KEDAR NATH DAS
 TBI 30-8412-33
 33.0cm



BOERMA
 TBI 30-8413-29
 29.0cm



LAUFE-PIPER
 TBI 30-8414-30
 30.0cm



LAUFE DIVERGENT OUTLET
 TBI 30-8415-31
 31.0cm

SIMPSON-LUIKART
 TBI 30-8416-36
 36.0cm



McLEAN
 TBI 30-8419-36
 36.0cm

KIELLAND-LUIKART
 TBI 30-8417-40
 40.0cm



McLEAN-TUCKER
 TBI 30-8420-39
 39.0cm

LUIKART
 TBI 30-8418-40
 40.0cm



McLEAN-TUCKER-LUIKART
 TBI 30-8421-40
 40.0cm



HIRST
 TBI 30-8422-26
 26.0cm



ANDERSON
 TBI 30-8423-38
 38.0cm



BARTON
 TBI 30-8424-36
 36.0cm

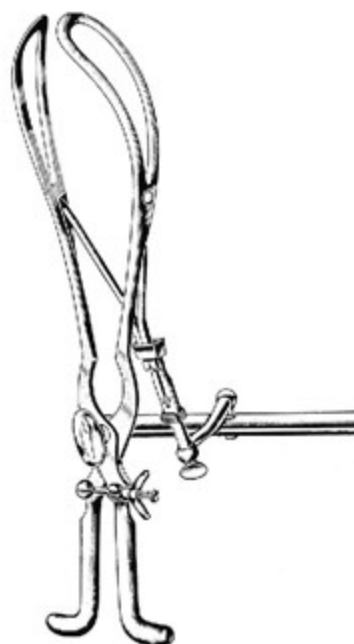

TARNIER
 TBI 30-8425-40
 40.0cm



KEDAR NATH DAS
 TBI 30-8426-38
 38.0cm



DEWEY
 TBI 30-8427-37
 37.0cm



BARNES-NEVILLE-SIMPSON
 TBI 30-8428-40
 40.0cm

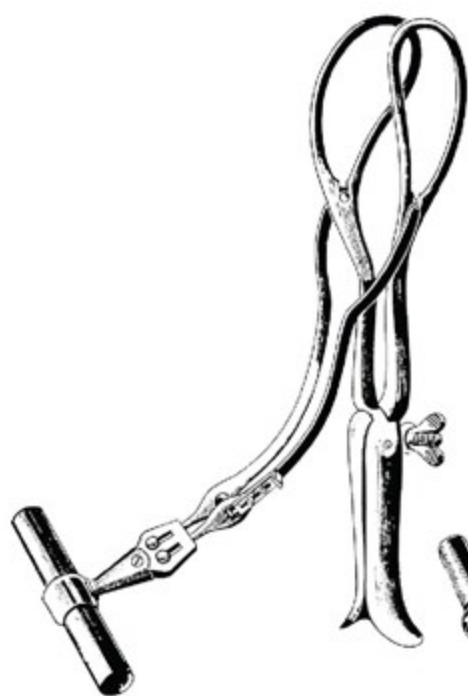

MILNE-MURRAY
TBI 30-8429-40
40.0cm



BARNES-NEVILLE
TBI 30-8430-40
40.0cm

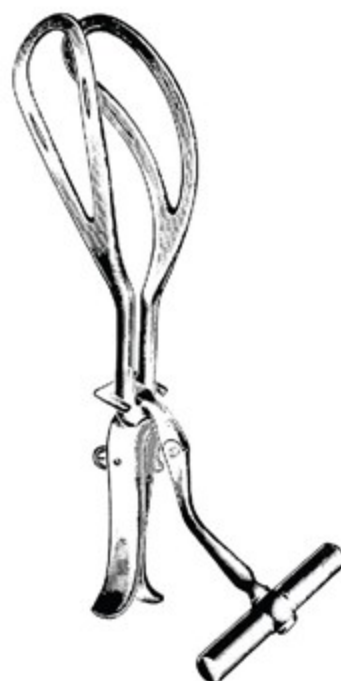

HAIG-FERGUSON
TBI 30-8431-40
40.0cm

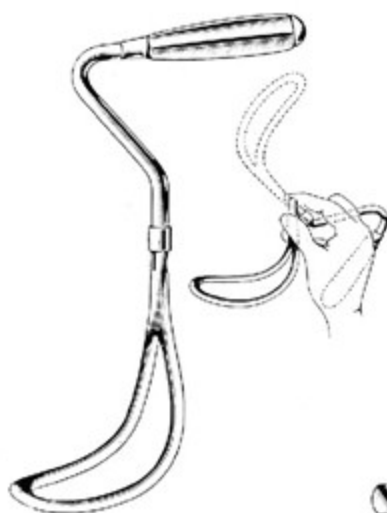

MURLESS
TBI 30-8432-26
26.0cm

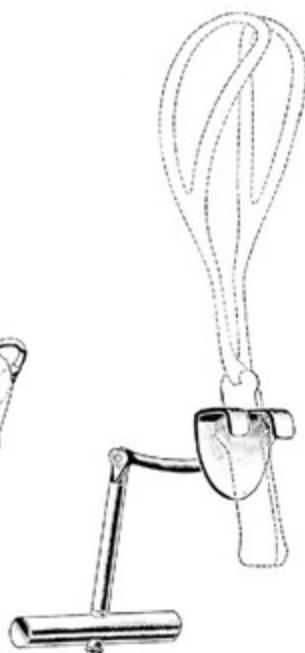

BILL
TBI 30-8433-21
21.0cm



LUIKART-BILL
TBI 30-8434-21
21.0cm



BARTON
TBI 30-8435-17
17.0cm



SMELLIE
 TBI 30-8436-25
 25.0cm



NAEGELE
 TBI 30-8437-25
 25.0cm



WINTER
 TBI 30-8438-36
 36.0cm

AUVARD-ZWEIFEL
 TBI 30-8439-42
 42.0cm

TARNIER
 TBI 30-8440-46
 46.0cm

BRAUN
 TBI 30-8441-42
 42.0cm



GREEN-ARMYTAGE
TBI 30-8442-21
21.0cm



GREEN-ARMYTAGE
TBI 30-8443-19
19.5cm



GAUSS
TBI 30-8444-26
26.0cm

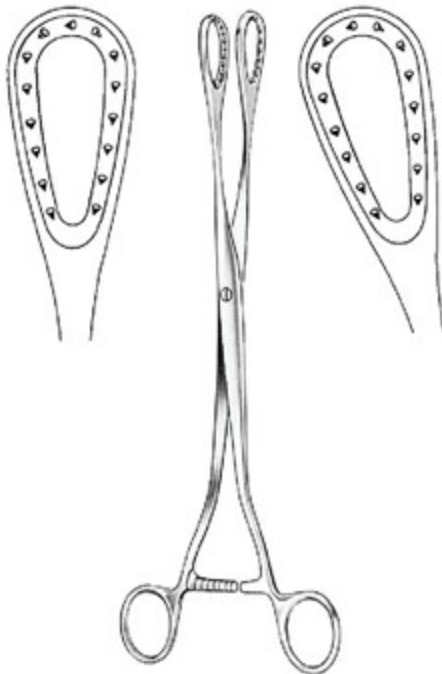

SAENGER
TBI 30-8445-27 27.0cm TBI 30-8446-27



SELLHEIM
TBI 30-8447-28
28.0cm



KANE
TBI 30-8448-08
8.5cm



COLLIN
TBI 30-8449-09
9.0cm



HEYWOOD-SMITH
 TBI 30-8450-25
 25.0cm



COREY
 TBI 30-8451-24
 24.0cm



WILLET
 TBI 30-8452-19
 19.0cm



WINTER
 28.0cm

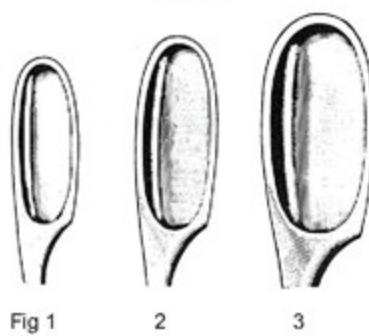
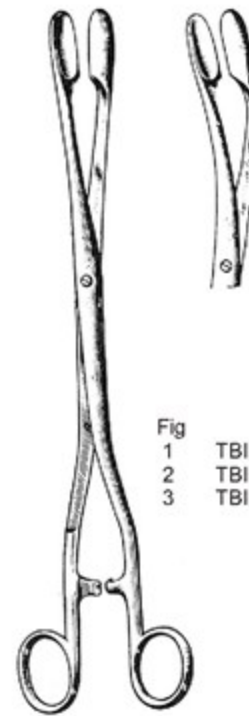

Fig	str	cur
1	TBI 30-8453-01	TBI 30-8454-01
2	TBI 30-8453-02	TBI 30-8454-02
3	TBI 30-8453-03	TBI 30-8454-03



WINTER-NASSAUER
 28.0cm

Fig	str	cur
1	TBI 30-8455-01	TBI 30-8456-01
2	TBI 30-8455-02	TBI 30-8456-02
3	TBI 30-8455-03	TBI 30-8456-03



Mc CLINTOCK
 TBI 30-8457-24
 24.0cm

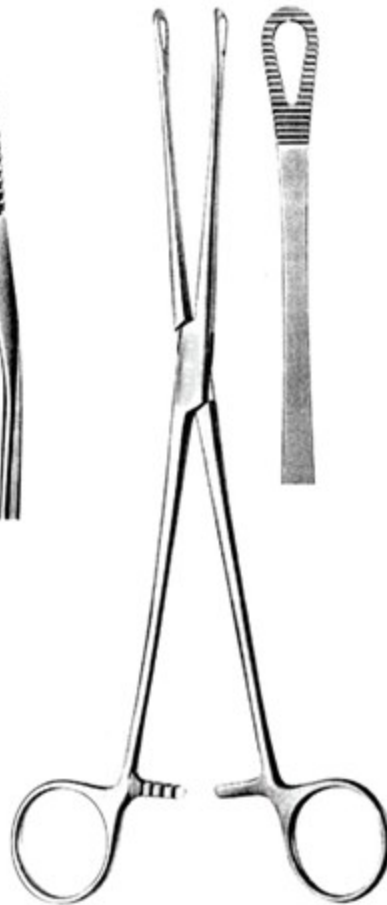

BONNEY
 TBI 30-8458-24
 24.0cm



VANT'S
 TBI 30-8459-24 24.0cm
 TBI 30-8459-27 27.0cm

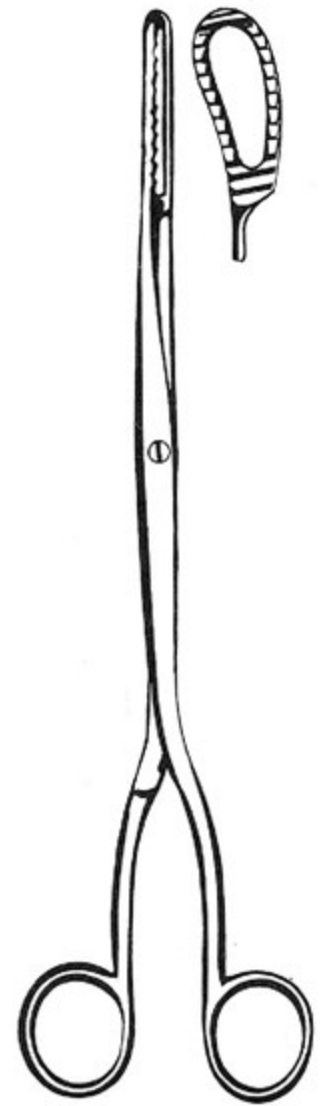

BIERER
 TBI 30-8460-28
 28.0cm

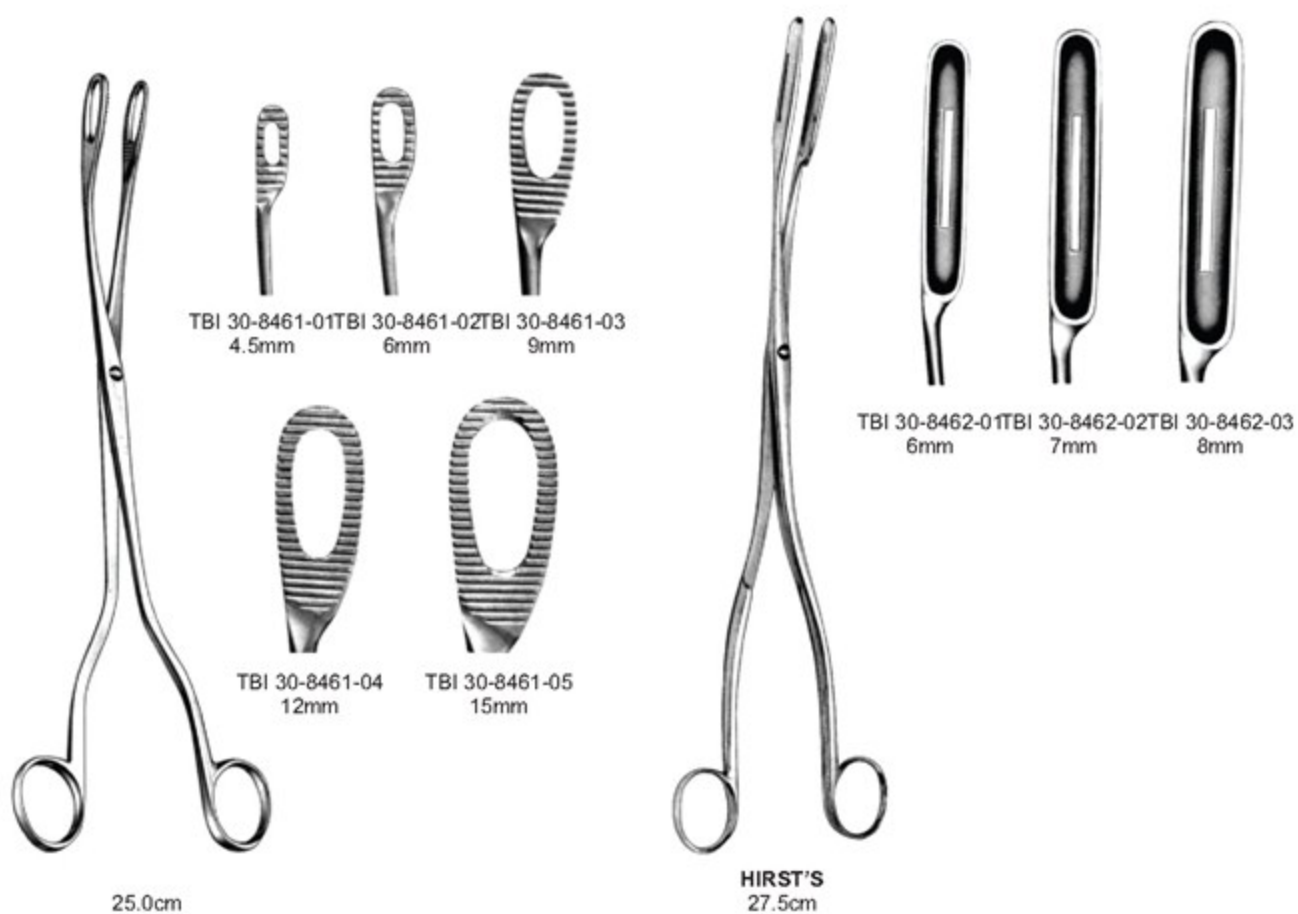

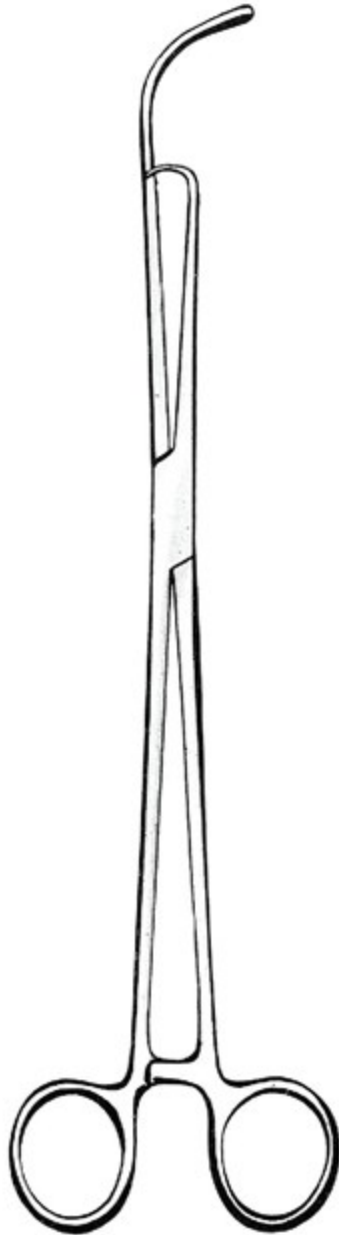

HULKA
 TBI 30-8463-30
 30.0cm

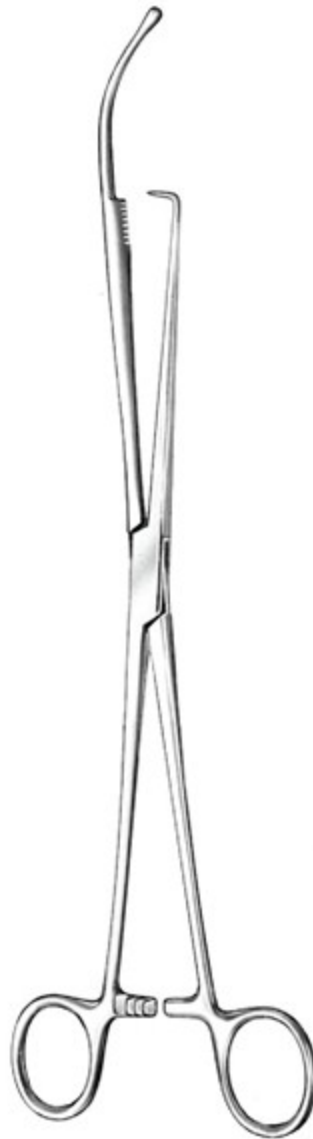

HULKA
 TBI 30-8464-30
 30.0cm

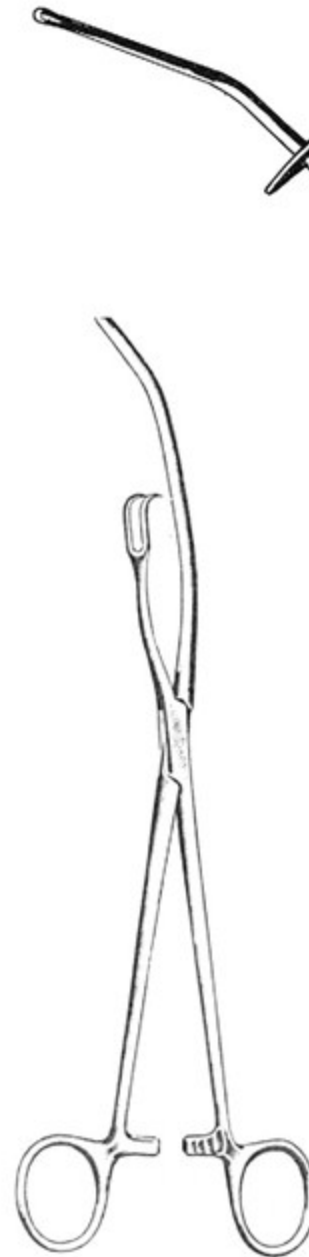

HULKA-KENWICK
 TBI 30-8465-27
 27.5cm

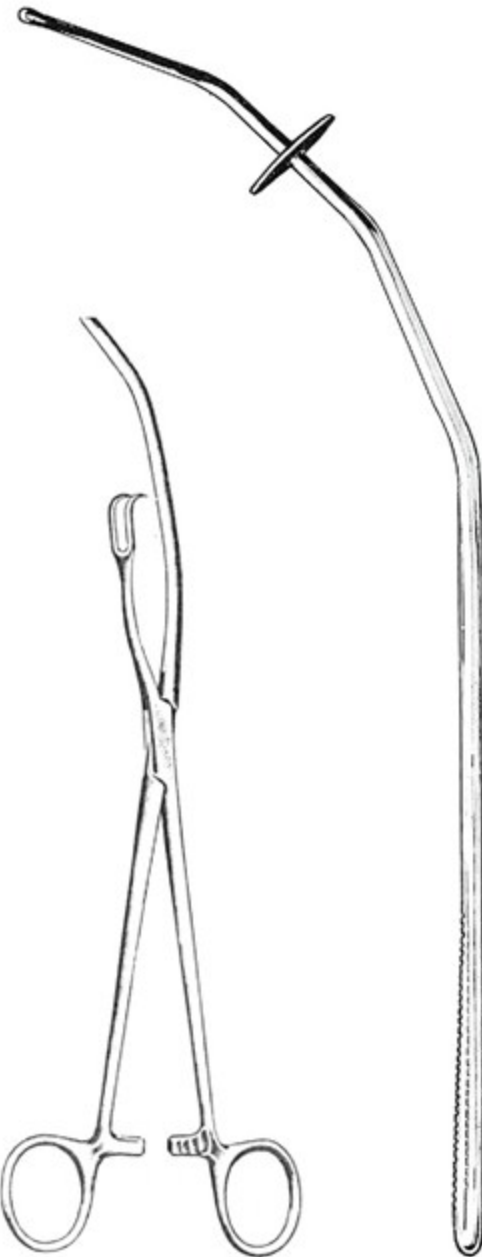

RAMATHIBODI
 TBI 30-8466-00



CARTON
 TBI 30-8467-30
 30.0cm
 5mm Ø



MARSHAL-COWELL
 TBI 30-8468-00



BOZEMANN-FRITSCH
 TBI 30-8469-08 8mm Ø
 TBI 30-8469-10 10mm Ø
 TBI 30-8469-12 12mm Ø



DREW-SMYTHE
 TBI 30-8470-33
 33.5cm

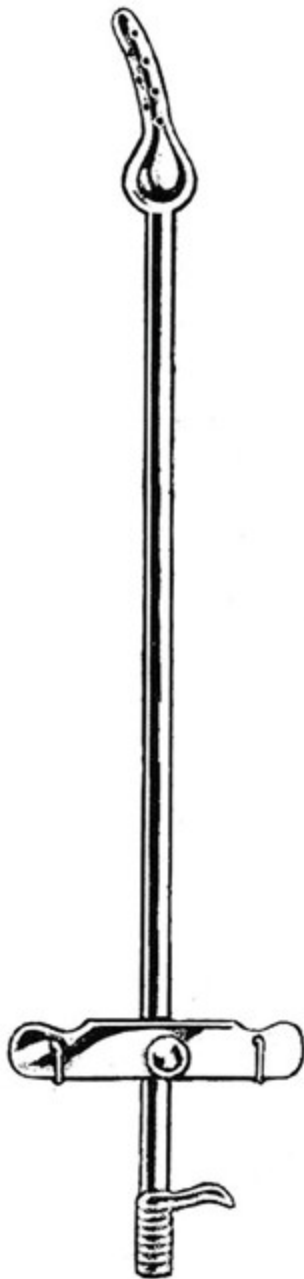

SPACKMANN
 TBI 30-8471-35
 35.0cm



SPACKMANN
 TBI 30-8472-35
 35.0cm



LEECH-WILKINSON
 26.5cm



TBI 30-8473-01
 Ø 10 x 25mm
 small



TBI 30-8473-02
 Ø 13 x 30mm
 medium



TBI 30-8473-03
 Ø 16 x 30mm
 large

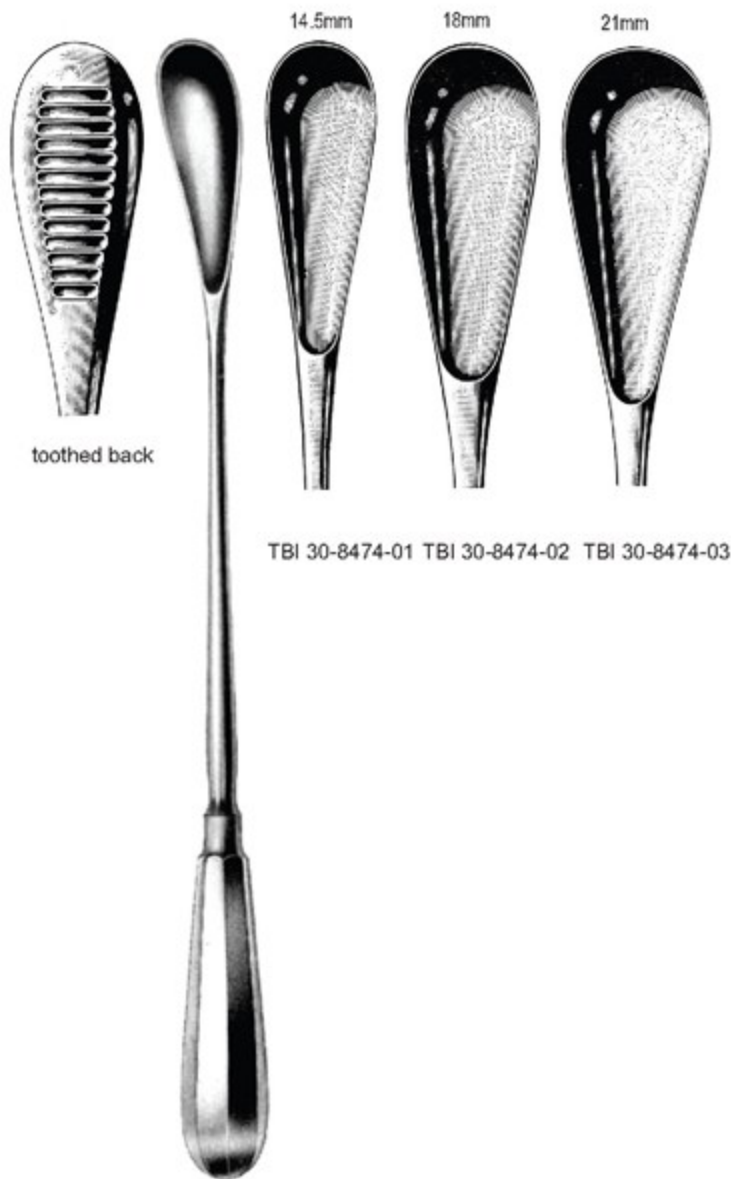

toothed back

TBI 30-8474-01 TBI 30-8474-02 TBI 30-8474-03

CUZZI
 30.0cm, blunt



TBI 30-8475-30

PESTALOZZA
 30.0cm

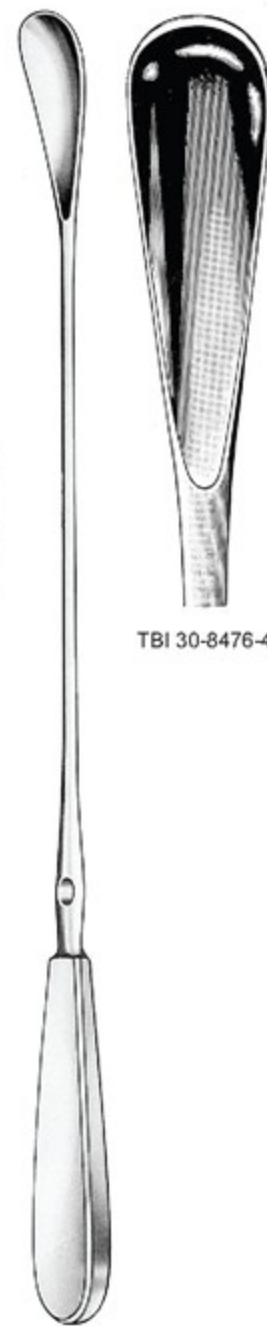

TBI 30-8476-42

WALLICH
 42.0cm, blunt



TBI 30-8477-03 3 mm Ø TBI 30-8478-04 4,5 mm Ø TBI 30-8479-06 6 mm Ø TBI 30-8480-08 8 mm Ø TBI 30-8481-10 10 mm Ø TBI 30-8482-12 12 mm Ø TBI 30-8483-14 14 mm Ø TBI 30-8484-50

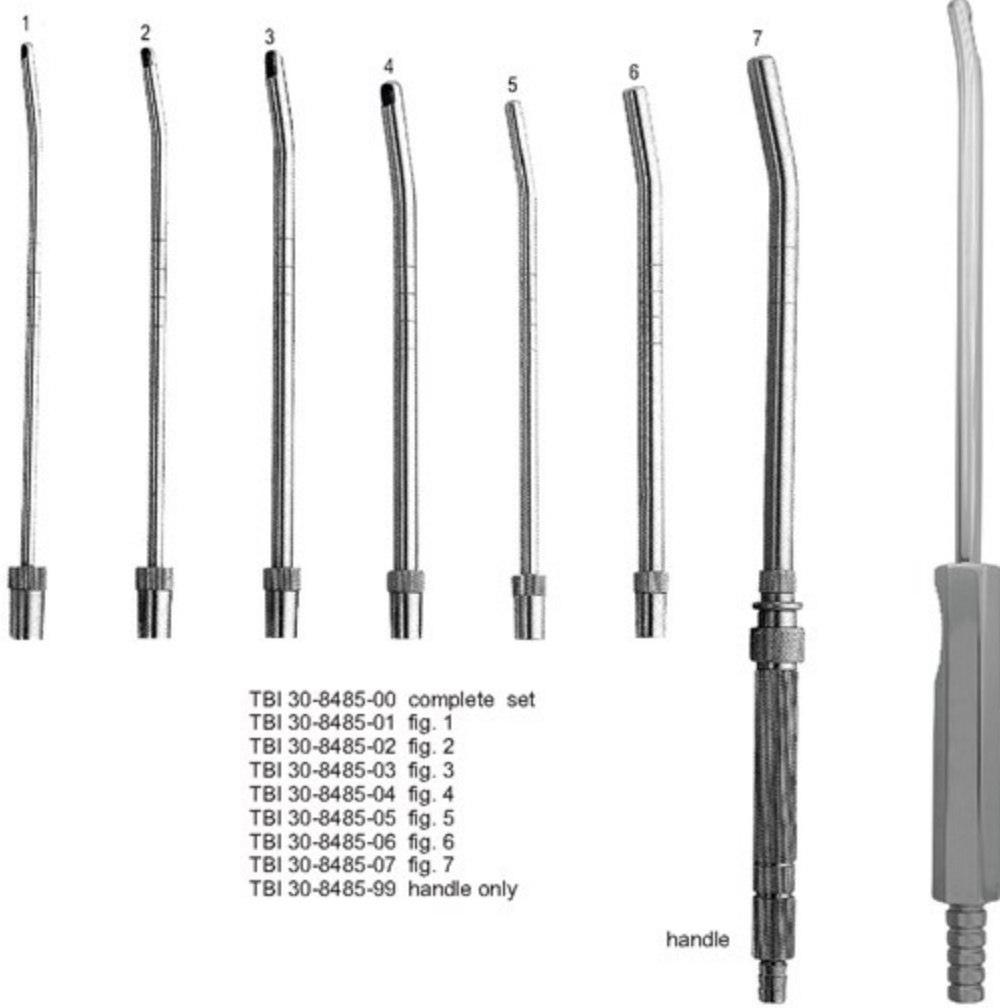

TBI 30-8485-00 complete set
 TBI 30-8485-01 fig. 1
 TBI 30-8485-02 fig. 2
 TBI 30-8485-03 fig. 3
 TBI 30-8485-04 fig. 4
 TBI 30-8485-05 fig. 5
 TBI 30-8485-06 fig. 6
 TBI 30-8485-07 fig. 7
 TBI 30-8485-99 handle only

handle

32.0cm
 TBI 30-8486-08 8mm
 TBI 30-8486-10 10mm
 TBI 30-8486-12 12mm



SMELLIE
TBI 30-8487-33
33.0cm



BRAUN
TBI 30-8488-30
30.0cm



TBI 30-8489-26
26.0cm



TARGETT
TBI 30-8490-30
30.0cm



RAMATHIBODI
TBI 30-8491-00



IUD
TBI 30-8492-00



TBI 30-8493-00



IUD
TBI 30-8494-00



COLLYER
 TBI 30-8495-33 33.0cm
 cm / inch scale



DELEE
 TBI 30-8496-20 20.0cm
 cm / inch scale



MARTIN
 TBI 30-8497-34 34.0cm
 TBI 30-8498-34 34.0cm
 cm / inch scale



COLLIN
 TBI 30-8499-35
 35.0cm
 cm scale

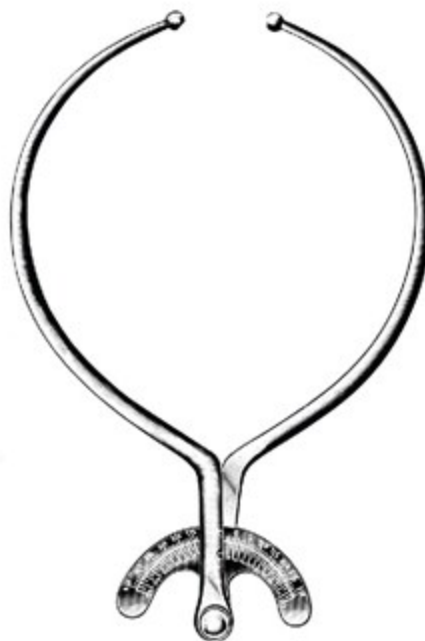

BREISKY
 TBI 30-8500-33
 33.0cm
 cm / inch scale

- EN** Goitre
- DE** Kropfchirurgie
- ES** Bocio

Page 741



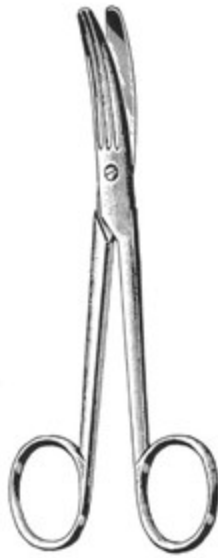

SCHOEMAKER
 OI 31-8601-15
 15.0cm

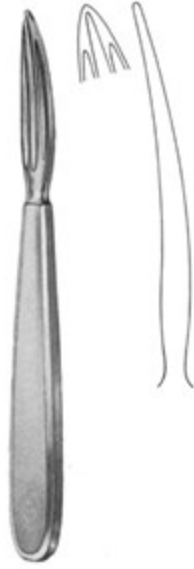

KOCHER
 OI 31-8602-15 15.0cm
 OI 31-8602-16 16.0cm

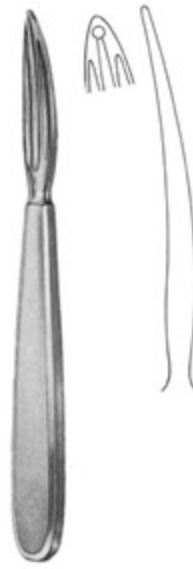

KOCHER
 OI 31-8603-15
 OI 31-8603-16



KOCHER
 OI 31-8604-18
 18.0cm



HOFMEISTER
 OI 31-8605-21
 21.0cm



LAHEY
 OI 31-8606-15 15.0cm
 OI 31-8606-20 20.0cm



MASTIN
 OI 31-8607-17
 17.0cm

- EN** Sterilization
- DE** Sterilisation
- ES** Esterilización

Page 742 to 743

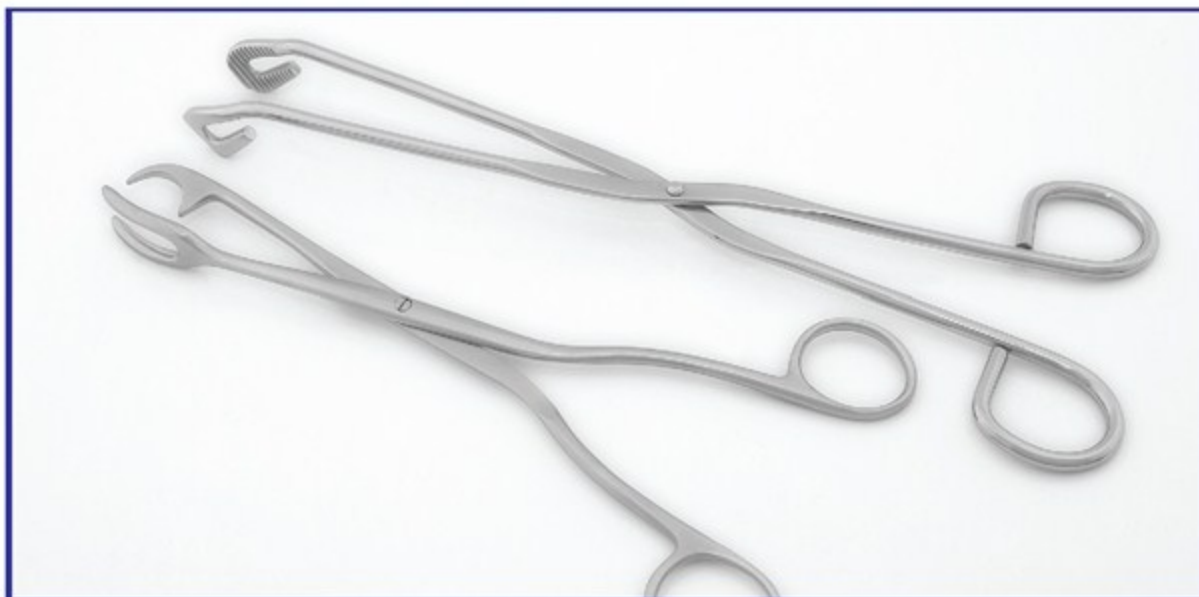



CHEATLE
 TBI 32-8701-27
 27.0cm



CHEATLE
 TBI 32-8702-26
 26.5cm



CHEATLE
 TBI 32-8703-28
 28.0cm



TBI 32-8704-20 20.0cm
 TBI 32-8704-30 30.0cm



ROGGE
 TBI 32-8705-23
 23.0cm



DAVIS
 TBI 32-8706-16 16.0cm
 TBI 32-8706-20 20.0cm
 TBI 32-8706-24 24.0cm



UNIVERSAL
 TBI 32-8707-20 20.0cm
 TBI 32-8707-28 28.0cm



UNIVERSAL
 TBI 32-8708-20 20.0cm
 TBI 32-8708-28 28.0cm



PYE-SMITH (HARRISON)
 TBI 32-8709-25 25.0cm
 TBI 32-8709-30 30.0cm



HARRISON
 TBI 32-8710-25 25.0cm
 TBI 32-8710-30 30.0cm
 TBI 32-8710-35 35.0cm
 TBI 32-8710-45 45.0cm

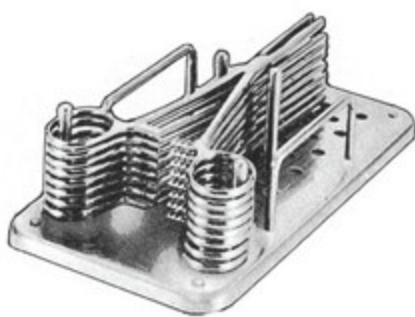

TBI 32-8711-00



BUNT
 TBI 32-8712-12 12.0cm



MAYO
 TBI 32-8713-10 10.0cm
 TBI 32-8713-12 12.0cm
 TBI 32-8713-14 14.0cm
 TBI 32-8713-15 15.0cm



MAYO
 TBI 32-8714-14 14.0cm

EN Asepsis

DE Asepsis

ES Asepsia

Page 744 to 745



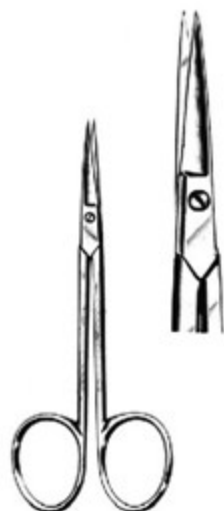

TBI 33-8801-10
10.5 cm/4"

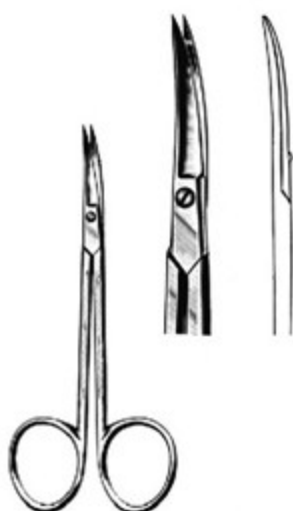

TBI 33-8802-10
10.5 cm/4"



TBI 33-8803-10
10.5 cm/4"



TBI 33-8804-10 10.5 cm/4"
 TBI 33-8804-11 11.5 cm/4 1/2"
 TBI 33-8804-13 13 cm/5"



TBI 33-8805-10 10.5 cm/4"
 TBI 33-8805-11 11.5 cm/4 1/2"
 TBI 33-8805-13 13 cm/5"
 TBI 33-8805-15 15 cm/6"



INGROWN TOE NAIL FORCEPS
ENGLISH (ANVIL) PATTERN
 TBI 33-8806-12
 12.5 cm/5"

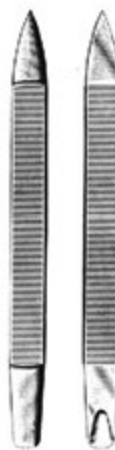

TBI 33-8807-10 10 cm/4"
 TBI 33-8807-12 12 cm/5"



TBI 33-8808-16
 16 cm/6 1/2"



TBI 33-8809-09 9 cm/3 1/2" TBI 33-8810-09
 TBI 33-8809-10 10 cm/4" TBI 33-8810-10
 TBI 33-8809-11 11cm/4 1/2" TBI 33-8810-11



TBI 33-8811-12 12 cm/5"
 TBI 33-8811-13 13 cm/5 1/4"



TBI 33-8812-14
 14 cm/5 1/2"

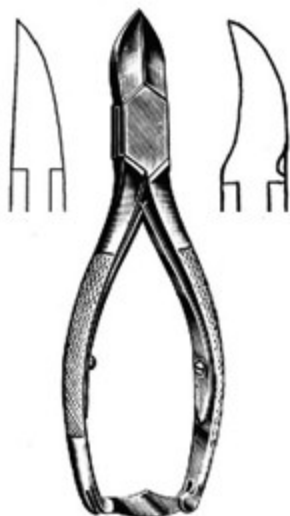

TBI 33-8814-14 14 cm/5 1/2"
 TBI 33-8814-16 16 cm/6 1/2"



TURNBULL
 TBI 33-8815-11 11 cm/4 1/2"
 TBI 33-8815-13 13 cm/5"



NAIL NIPPER
Double Action
 TBI 33-8816-15
 15 cm/6"

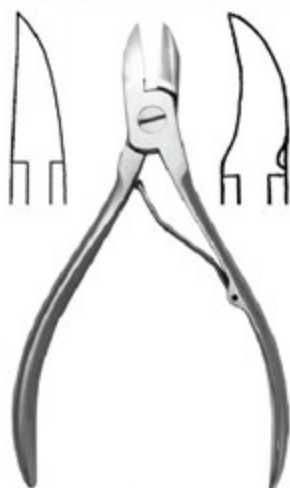

TBI 33-8817-12 12 cm/5" TBI 33-8818-12
 TBI 33-8817-13 13 cm/5 1/2" TBI 33-8818-13



TBI 33-8819-15
 S/E



TBI 33-8820-15
 D/E



EN Hollowware

DE Hollowware

ES Hollowware

Page 746 to 753





Needle Case Round with Cover
 TBI 34-8901-01 65x15mm



Needle Case Round
 TBI 34-8902-01 80x20mm



Needle Case Rectangle
 TBI 34-8903-01 70x70x10mm



Endodontic Box
 TBI 34-8904-01
 100x40x50mm



Tube Rack

TBI 34-8905-01 6.35x15.25x5cm for 12 tubes
 TBI 34-8905-02 6.35x17.75x7.5cm for 27 tubes
 TBI 34-8905-03 7.50x17.75x6.35cm for 36 tubes



Sprit Lamp
 TBI 34-8906-01
 Standard Size



Sprit Lamp
 TBI 34-8907-01
 Standard Size



Sputum Cup
 TBI 34-8908-01 75x80mm
 TBI 34-8908-02 100x50mm
 TBI 34-8908-03 100x80mm



Dressing Jar

TBI 34-8909-01	80x60mm	TBI 34-8910-01
TBI 34-8909-02	80x80mm	TBI 34-8910-02
TBI 34-8909-03	100x100mm	TBI 34-8910-03
TBI 34-8909-04	120x120mm	TBI 34-8910-04
TBI 34-8909-05	150x150mm	TBI 34-8910-05
TBI 34-8909-06	180x180mm	TBI 34-8910-06
TBI 34-8909-07	200x200mm	TBI 34-8910-07



Dressing Jar



Fennle

TBI 34-8912-01	100mm Ø
TBI 34-8912-02	120mm Ø
TBI 34-8912-03	150mm Ø
TBI 34-8912-04	200mm Ø



Cotton Holder
TBI 34-8911-01

Cotton Holder
TBI 34-8911-02



Forceps Jar

TBI 34-8913-01	30x90mm
TBI 34-8913-02	50x125mm
TBI 34-8913-03	50x170mm
TBI 34-8913-04	50x200mm
TBI 34-8913-05	40x230mm
TBI 34-8913-06	70x110mm
TBI 34-8913-07	80x150mm
TBI 34-8913-08	100x200mm
TBI 34-8913-09	150x30mm



Gallipot

TBI 34-8914-01	01 oz	TBI 34-8914-09	09 oz
TBI 34-8914-02	02 oz	TBI 34-8914-10	10 oz
TBI 34-8914-03	03 oz	TBI 34-8914-11	11 oz
TBI 34-8914-04	04 oz	TBI 34-8914-12	12 oz
TBI 34-8914-05	05 oz	TBI 34-8914-13	13 oz
TBI 34-8914-06	06 oz	TBI 34-8914-14	14 oz
TBI 34-8914-07	07 oz	TBI 34-8914-15	15 oz
TBI 34-8914-08	08 oz	TBI 34-8914-16	16 oz



Spong Bowl

TBI 34-8915-01	12 cm
TBI 34-8915-02	15 cm
TBI 34-8915-03	20 cm



**Medicine Cup**

TBI 34-8916-01 50ml
 TBI 34-8916-02 60ml
 TBI 34-8916-03 70ml

**Lotion Bowl without spout**

TBI 34-8917-01 40x19mm TBI 34-8917-08 150x65mm
 TBI 34-8917-02 50x25mm TBI 34-8917-09 180x85mm
 TBI 34-8917-03 60x30mm TBI 34-8917-10 200x100mm
 TBI 34-8917-04 80x40mm TBI 34-8917-11 250x120mm
 TBI 34-8917-05 100x50mm TBI 34-8917-12 300mm
 TBI 34-8917-06 120x60mm TBI 34-8917-13 350mm
 TBI 34-8917-07 140x60mm TBI 34-8917-14 400mm

**Wash Basin**

TBI 34-8918-01 300x80mm
 TBI 34-8918-02 320x85mm
 TBI 34-8918-03 330x90mm
 TBI 34-8918-04 350x110mm
 TBI 34-8918-05 400x115mm

**Kick Bucket with Trolley**

TBI 34-8919-01
 390x280x180mm

**Kidney Tray Shallow**

TBI 34-8920-01 17cm
 TBI 34-8920-02 22cm
 TBI 34-8920-03 24cm

**Kidney Tray**

TBI 34-8921-01 12cm
 TBI 34-8921-02 15cm
 TBI 34-8921-03 18cm
 TBI 34-8921-04 20cm
 TBI 34-8921-05 25cm
 TBI 34-8921-06 28cm
 TBI 34-8921-07 30cm

**Kidney Tray (with cover)**

TBI 34-8922-01 15cm
 TBI 34-8922-02 20cm
 TBI 34-8922-03 25cm
 TBI 34-8922-04 30cm

HOLLOWARE

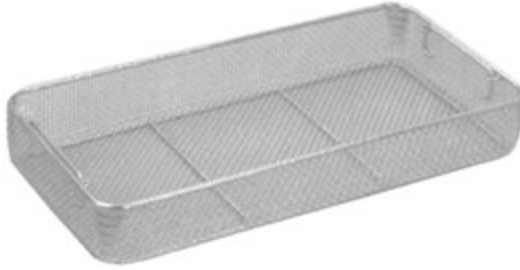

Wire Mesh Tray

- TBI 34-8923-01 240x250x5mm
- TBI 34-8923-02 480x250x5mm
- TBI 34-8923-03 550x250x5mm
- TBI 34-8923-04 240x250x7mm
- TBI 34-8923-05 480x250x7mm
- TBI 34-8923-06 240x250x10mm
- TBI 34-8923-07 480x250x10mm



Wire Mesh Tray with Lid

- TBI 34-8924-01 240x250x5mm
- TBI 34-8924-02 480x250x5mm
- TBI 34-8924-03 550x250x5mm
- TBI 34-8924-04 240x250x7mm
- TBI 34-8924-05 480x250x7mm
- TBI 34-8924-06 240x250x10mm
- TBI 34-8924-07 480x250x10mm



Perforated Tray

- TBI 34-8925-01 200x100x40mm
- TBI 34-8925-02 250x120x50mm
- TBI 34-8925-03 300x150x50mm
- TBI 34-8925-04 350x170x50mm
- TBI 34-8925-05 400x200x50mm



Instruments Tray without Lid

- TBI 34-8926-01 100x150x25mm
- TBI 34-8926-02 150x200x40mm
- TBI 34-8926-03 200x250x45mm
- TBI 34-8926-04 250x300x50mm
- TBI 34-8926-05 300x350x50mm
- TBI 34-8926-06 150x300x50mm
- TBI 34-8926-07 200x300x50mm
- TBI 34-8926-08 230x150x50mm



Instruments Tray with Lid

- TBI 34-8927-01 100x150x25mm
- TBI 34-8927-02 150x200x40mm
- TBI 34-8927-03 200x250x45mm
- TBI 34-8927-04 250x300x50mm
- TBI 34-8927-05 300x350x50mm
- TBI 34-8927-06 150x300x50mm
- TBI 34-8927-07 200x300x50mm
- TBI 34-8927-08 230x150x50mm





Burr Tray
 TBI 34-8928-01
 190x100x20mm



Cathetes Tray with Lid
 TBI 34-8929-01 300x80x40mm
 TBI 34-8929-02 350x90x45mm
 TBI 34-8929-03 400x100x50mm

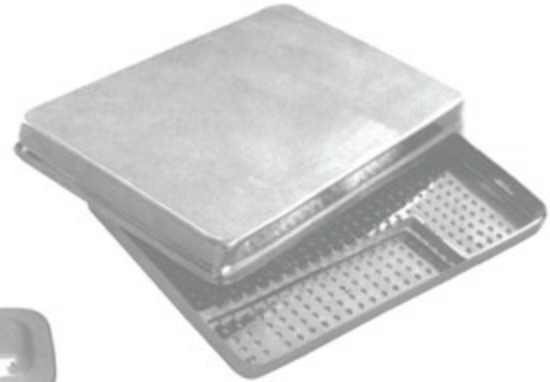

Scaler Tray with cover
 TBI 34-8930-01
 200x100x16mm



**Instruments Box
 with Hooks**

TBI 34-8931-01 170x70x30mm
 TBI 34-8931-02 180x80x40mm
 TBI 34-8931-03 200x100x40mm
 TBI 34-8931-04 230x120x50mm
 TBI 34-8931-05 250x125x50mm
 TBI 34-8931-06 300x150x50mm
 TBI 34-8931-07 350x170x50mm
 TBI 34-8931-08 400x200x90mm
 TBI 34-8931-09 500x200x120mm



Instruments Box

TBI 34-8932-01 170x70x30mm
 TBI 34-8932-02 180x80x40mm
 TBI 34-8932-03 200x100x40mm
 TBI 34-8932-04 230x120x50mm
 TBI 34-8932-05 250x125x50mm
 TBI 34-8932-06 300x150x50mm
 TBI 34-8932-07 350x170x50mm
 TBI 34-8932-08 400x200x90mm
 TBI 34-8932-09 500x200x120mm



**Instruments Box
Perforated**

- TBI 34-8933-01 200x100x40mm
- TBI 34-8933-02 250x150x40mm
- TBI 34-8933-03 300x150x40mm



Electric Sterilizer

- TBI 34-8934-01 200x100x120mm
- TBI 34-8934-02 250x120x140mm
- TBI 34-8934-03 300x150x150mm
- TBI 34-8934-04 350x170x170mm
- TBI 34-8934-05 400x200x180mm
- TBI 34-8934-06 450x230x190mm



Non Electric Sterilizer

- TBI 34-8935-01 200x100x65mm
- TBI 34-8935-02 250x125x65mm
- TBI 34-8935-03 300x150x100mm
- TBI 34-8935-04 350x170x65mm
- TBI 34-8935-05 400x200x100mm



Electric Sterilizer

- TBI 34-8936-01
280x125x65mm

- TBI 34-8937-01 125x80mm
- TBI 34-8937-02 125x120mm
- TBI 34-8937-03 150x100mm
- TBI 34-8937-04 150x150mm
- TBI 34-8937-05 180x180mm
- TBI 34-8937-06 190x140mm
- TBI 34-8937-07 190x190mm
- TBI 34-8937-08 200x200mm
- TBI 34-8937-09 240x120mm
- TBI 34-8937-10 240x240mm
- TBI 34-8937-11 290x140mm
- TBI 34-8937-12 290x240mm
- TBI 34-8937-13 290x290mm
- TBI 34-8937-14 340x160mm
- TBI 34-8937-15 340x340mm
- TBI 34-8937-16 390x150mm
- TBI 34-8937-17 390x200mm
- TBI 34-8937-18 390x290mm



Sterilizer Drum





Bedpan Hand Made
 TBI 34-8938-01
 Standard



Bedpan Hand Made
 TBI 34-8939-01 Adult
 TBI 34-8939-02 Child



Bedpan Hand Made
 TBI 34-8940-01
 Standard



Bedpan Simple
 pressed body with handle
 TBI 34-8942-01 Adult
 TBI 34-8942-02 Child



Bedpan Sleeper Type
 TBI 34-8943-01 Adult
 TBI 34-8943-02 Child



Bedpan Chamber Port
 TBI 34-8944-01
 Standard



Urinal Female
 TBI 34-8945-01
 Standard

Urinal Male Vertical
 TBI 34-8946-01
 Standard

Urinal Male
 TBI 34-8947-01
 Standard



**Bedpan perfection
 type seamless**
 TBI 34-8948-01
 350x300mm



Bedpan perfection type
 TBI 34-8949-01 370x290mm
 TBI 34-8949-02 320x240mm



Measuring Jug
 TBI 34-8950-01 0.5 Ltr
 TBI 34-8950-02 1.0 Ltr
 TBI 34-8950-03 1.5 Ltr
 TBI 34-8950-04 2.0 Ltr



Pail/Bucket with Lid
 TBI 34-8951-01 06 Ltr
 TBI 34-8952-02 10 Ltr
 TBI 34-8952-03 15 Ltr



Douch Can/Irrigator
 TBI 34-8952-01 1.0 Ltr
 TBI 34-8952-02 1.5 Ltr
 TBI 34-8952-03 2.0 Ltr





Boghra, Haji Pura Road,
Sialkot - 51310, Pakistan
Cell: +92 341 4284906 (Mr. Ali)
Email: info@thebestind.com
Website: www.thebestind.com